

CHIKOUSA

CK- | STEEL SOLAR CARPORT | TRIDENT MOUNT

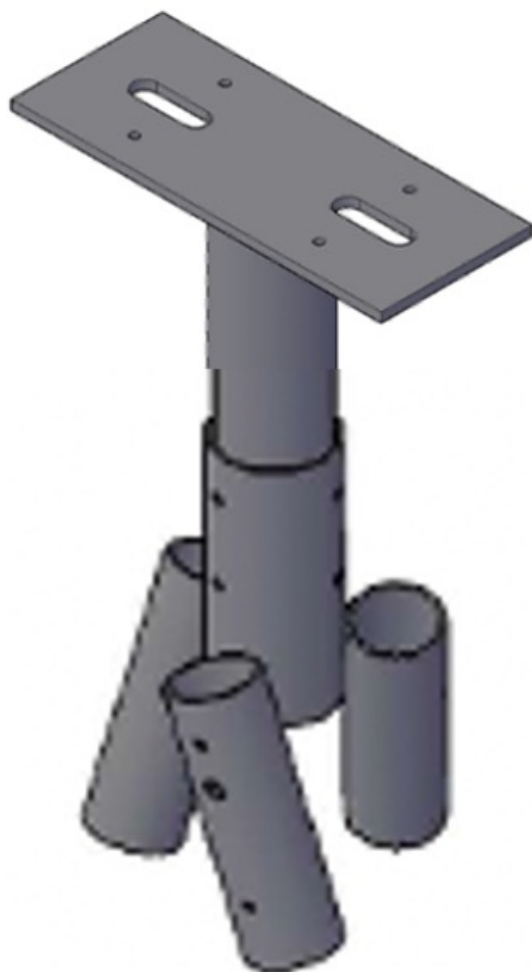

TRIDENT MOUNT INSTALLATION MANUAL

VERSION: 11.15.24 | ENG

Always use the most recent version of the installation manual before installing your Trident Mount. The installation Manual is subject to change without notice. Please consult with CHIKOUSA to ensure you are utilizing the latest Install Manual.

BRIEF DESCRIPTION

The Trident Mount is a simple and effective foundation system that serves as an alternative to traditional foundations. No digging, rebar or concrete is needed when using the Trident Mount. The installation can be installed with a 2 person crew, without the need of any heavy duty equipment. The installation should always be completed by trained professionals and/or qualified individuals, who have been adequately instructed and trained about the tasks involved with the installation, including the usage of protective devices, protective measures, relevant provisions, safety regulations and local operating site conditions and have proven competence in all areas of the installation.

Please read carefully this installation manual and all other applicable documents before starting your installation. Please contact CHIKOUSA with any questions that you may have.

MAINTENANCE

The Trident Mount and all components are Hot Dipped Galvanized to Provide effective, long-life protection in all conditions. Because the Trident Mounts are all steel construction they are non combustible and will not rot, warp, shrink, and are impervious to termites.

TRIDENT MOUNT INSTALLATION WARNING

Anyone who plans to utilize the Trident Mount should call 811 or visit their state's 811 center's website a few business days before using the Trident Mount to request that the approximate location of buried utilities be marked with paint or flags so that you don't unintentionally drive a pile into an underground utility line.

MEASUREMENT NOTE

Some measurements have been converted from MM to inches. The accuracy of measurements can vary slightly from mm to inches. All measurements are available in MM for detailed accuracy.

REQUIRED INSTALLATION TOOLS

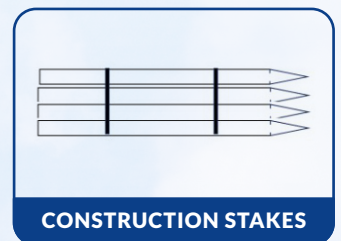
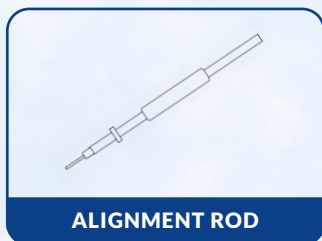
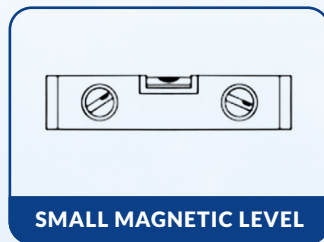
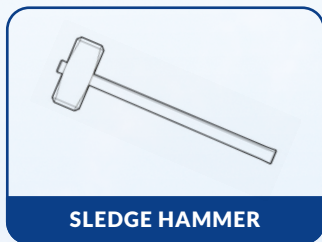
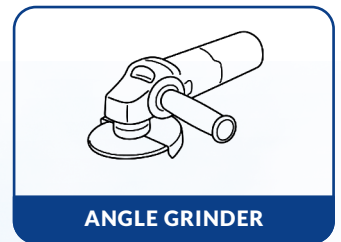
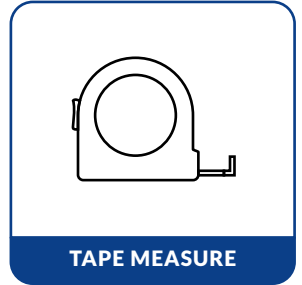
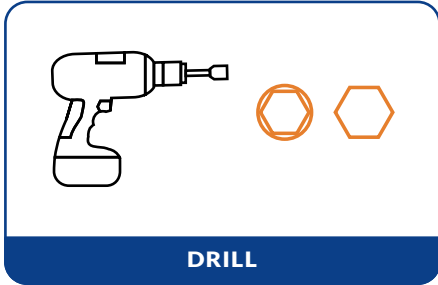

MAIN COMPONENTS

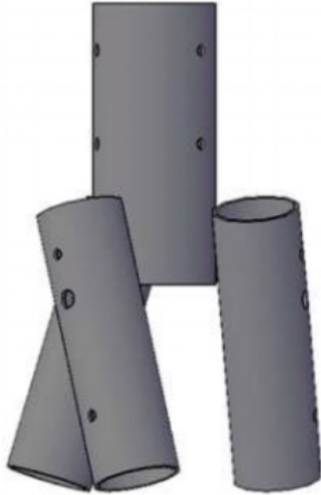

TRIDENT MOUNT

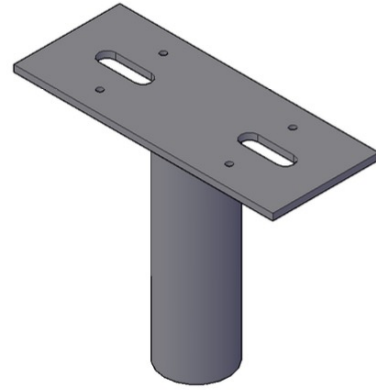

TOP FLANGE



3 PILES



TEK SCREWS

TRIDENT MOUNT DESIGN PRINCIPLES

General Design Principles:

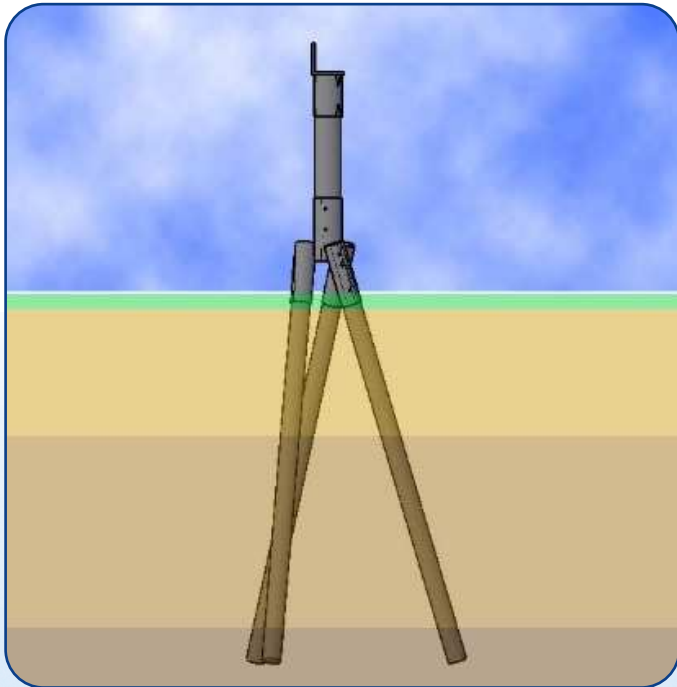

The Trident Mount is a pile anchor system that shares 3 Main aspects(piles) to create the foundation.

The combination of friction, end bearing, and axial are supported by the 3 incline piles in a geometric configuration. (Axial Load Distribution)

The Trident mount has 2 main design factors- the structural capacity of the Trident Mount components and the structural capacity of the founding material.

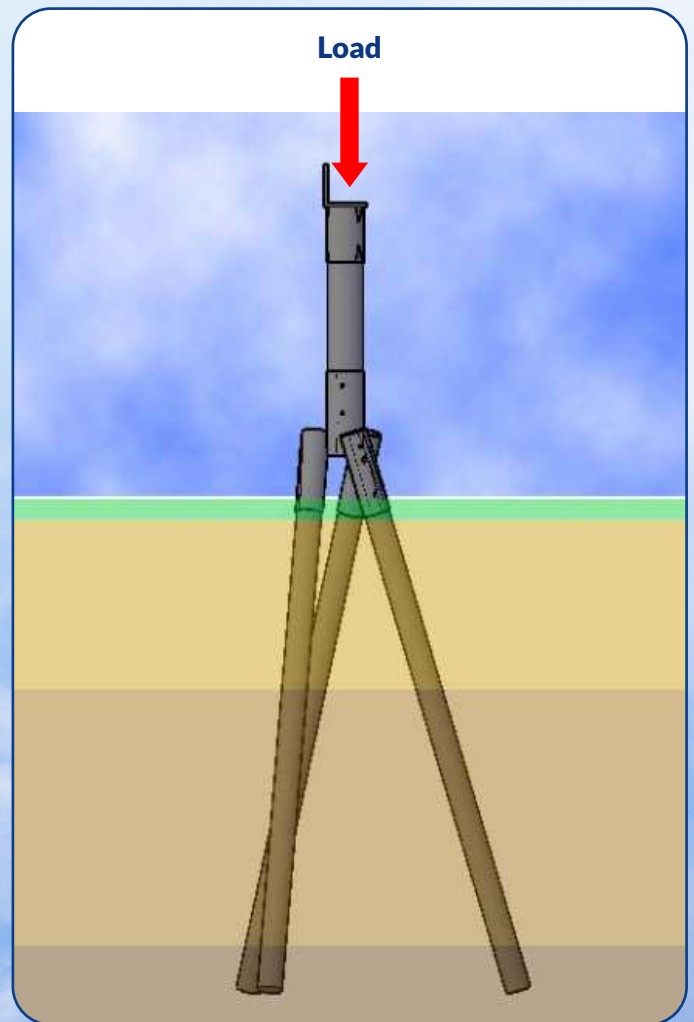
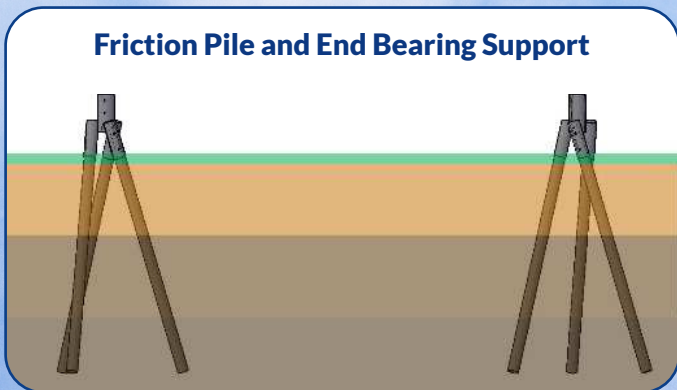
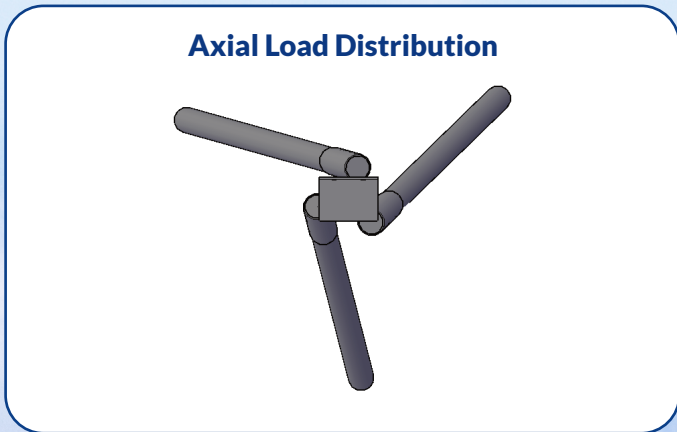

TRIDENT MOUNT INSTALLATION WARNING

Safety Notes:



Warning:

Anyone who plans to utilize the Trident Mount should call 811 or to your state's 811 center's website a few business days before using the Trident Mount to request that the approximate location of buried utilities to be marked with paint or flags so that you don't unintentionally drive a pile into an underground utility line.

811 protects you and your community! Hitting a buried line while driving a Trident Mount Pile can disrupt utility service, cost Money to repair, or cause serious injury or death. Always contact you 811 center, wait the required time for utilities to respond to your request, and ensure that all utilities have responded to your request before driving a pile into the ground.

You will need to know the address of where you plan to dig, including the county and nearest cross street, as well as the type of project you're completing and the exact area on the property where you're planning to install the trident mounts. Whether you Call 811 or make your request online, you'll need the same info.



Warning:

Appropriate safety equipment must be worn when installing The Trident Mount.

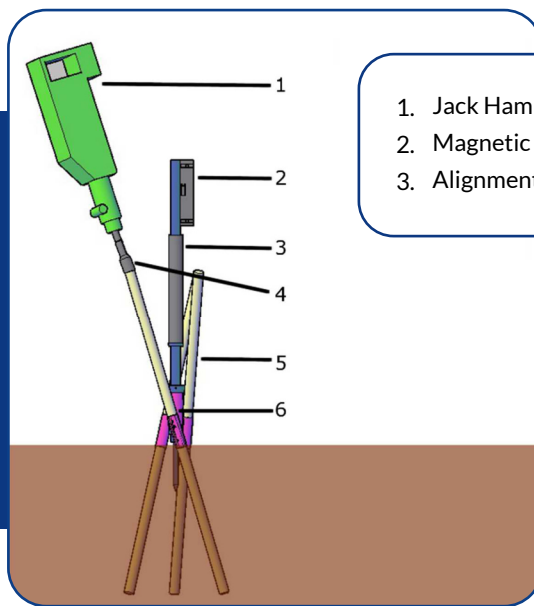

- | | |
|-------------------|---------------------------|
| 1. Jack Hammer | 4. Post Driver Attachment |
| 2. Magnetic Level | 5. Pile |
| 3. Alignment Rod | 6. Trident Mount |

Basic Installation:

Trident Mount is placed on the ground in the location where it is required. The alignment rod holds the Trident Mount in place while it is being installed and is used to adjust the anchor during installation to keep the Trident Mount plumb. The 3 piles are then driven into the ground through the Trident Mount pile guides. The piles are screwed to the Trident Mount frame locking the Trident Mount in place.

After the Trident Mount has been installed, drop the Top Flange into the center section of the Trident Mount. Secure the Flange With Tek Screws through the pre-drilled holes in the Trident Mount.

INSTALLATION STEPS

Step 1 : Site Preparation

Marking Out

Marking out where the Trident Mounts will go is one of the most important steps during the installation process because once the piles are installed they are not easy to remove. To determine the exact location of the Trident Mounts, run a string line between 2 points and measure out where the Trident Mounts are to be placed marking the ground with marking paint then plumb down from the line pinpointing the exact location for the Trident mounts. Using a screw driver mark the intersection by pushing a screw driver into the ground making a prominent hole in the ground.

Ensure you have followed 811 procedures and know and avoid where any underground utility lines are located. The site set out is the most important part of the Trident Mount installation, after you have completed your initial layout mark the center lines where the Trident Mounts are to be installed then mark the location of each Trident Mount.

Tip: Setting up profiles and running string lines down the Trident Mount center line will help to accurately mark the Trident Mount locations.

Tip: Projecting the string line down as close to the ground as possible, can increase accuracy and make it easier to mark the Trident Mount locations.

Tip: Use tent pegs, wooden stakes, long screws, or paint to mark the Trident Mount locations, the markers will be used as a guide for the alignment rod.

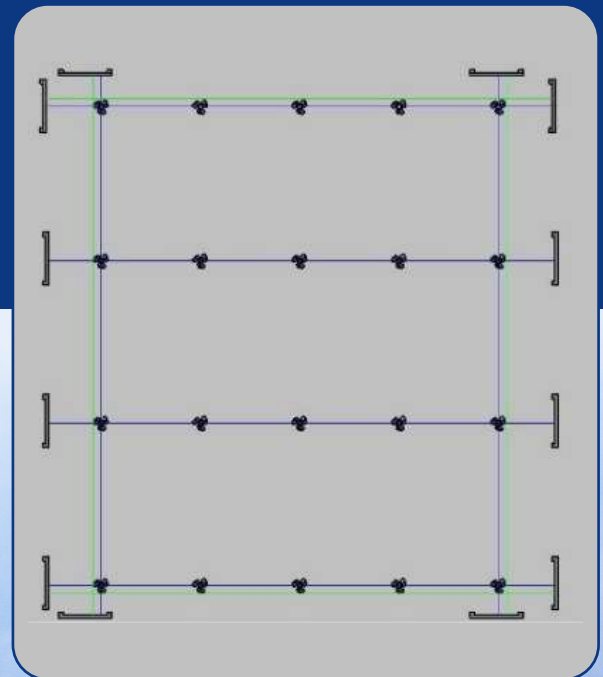
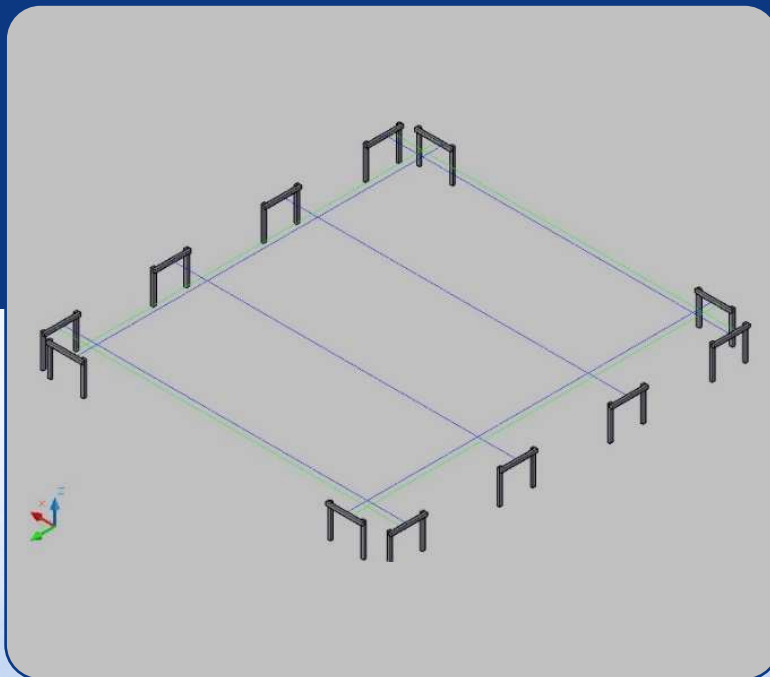

Step 2 : Aligning the Trident Mount

Use the alignment rod to align the Trident Mount.

1. Slide the Trident Mount over the end of the alignment rod.
2. Place the alignment rod spike in the location where the Trident Mount will be installed.
3. If needed, use the hand hammer to drive the alignment rod spike into the ground while keeping the alignment rod plumb using the magnetic level.

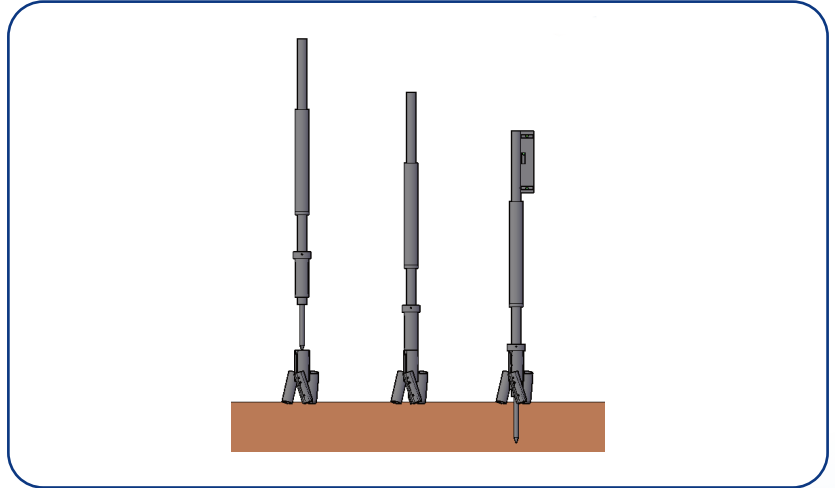

Step 3 : Driving the Piles

1. Place 3 piles in the Trident Mount Pile Guides
2. Check that the Trident Mount is Plumb

Note: A sledge hammer can also be used to drive the piles into the ground.

Note: When using a jack hammer to drive the piles into the ground it is Important to keep the post driver attachment square with the top of the Pile.

Tip: When driving the piles, it is recommended that a second person holds the alignment rod while the other person drives the piles



Step 3 : Driving the Piles, Continued

3. Drive one pile through the Trident Mount pile guides approximately $\frac{1}{2}$ way into the ground. Now ensure the Trident Mount is plumb and level, if needed use the alignment rod to adjust the Trident Mount. Now drive the 2nd pile through the Trident Mount pile guide approximately $\frac{1}{2}$ way into the ground. Now ensure the Trident Mount is plumb and level, if needed use the alignment rod to adjust the Trident Mount. Now drive the 3rd pile through the Trident Mount pile guide approximately $\frac{1}{2}$ way into the ground. Now ensure the Trident Mount is plumb and level, if needed use the alignment rod to adjust the Trident Mount.

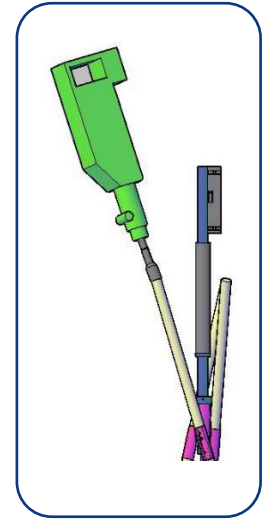
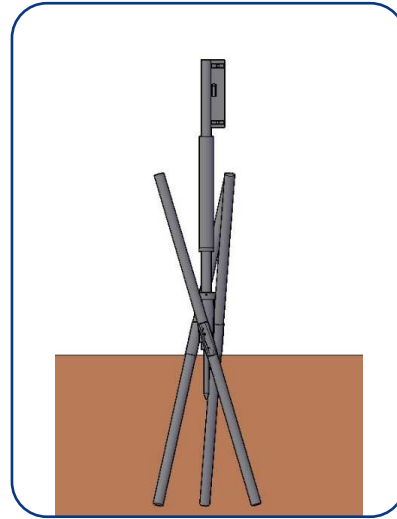

4. When the piles have been driven half way into the ground remove the alignment rod from the Trident Mount.

Note: After the Trident Mount piles have been installed half way there will be minimal adjustment, however, it is important to keep the Trident Mount plumb while driving the piles the remaining distance into the ground.

Tip: After you have removed the alignment rod start setting up the next Trident Mount while the second person finishes driving the piles for the Trident Mount currently being installed.

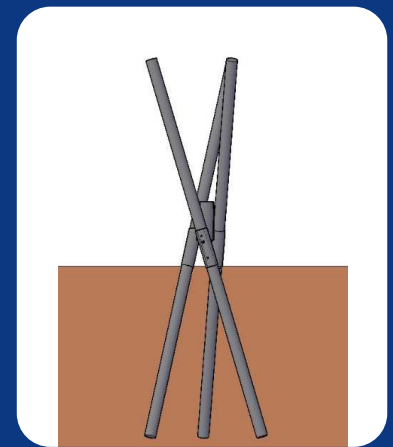

5. Finish driving the piles into the ground.

Note: If a pile reaches the point of practical refusal and that pile cannot be driven all the way into the ground, the excess can be cut off. However, if this occurs any cut edge must be painted with cold galvanized paint. If refusal occurs on more than 5% of the total number of piles during an installation or if more than one of the three piles on any single Trident Mount encounter refusals an engineer must approve those current site conditions.

Note: in some cases, if practical refusal is encountered while driving the piles, an engineer may need to approve an alternate foundation method.

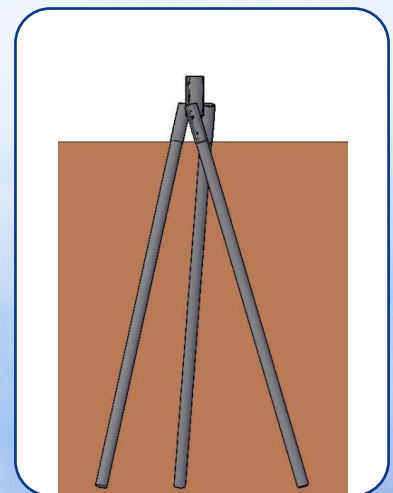

Step 4 : Fixing the Trident Mount to the Piles

Using a drill fix the piles to the Trident Mount, there are four pre-drilled holes in each pile that mark the locations for the tek screws.

Note: In some cases it may not be possible to drill through the pre drilled holes, in this case you can drill through the pile guide.

Note: In some cases bolts may be used to connect the piles to the Trident Mount frame.

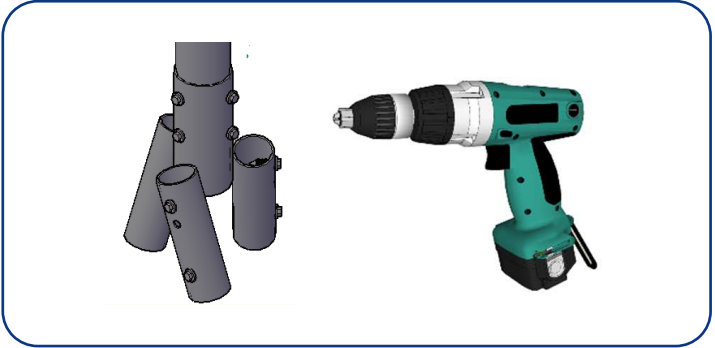

Step 5 : Setting and Fixing the Top Flange

After the piles have been fixed to the Trident Mount frame:

1. Measure the distance from the ground to the required height.
2. There is some slight height adjustability when setting the Top Flange into the Trident Mount. Determine the correct height and Secure the Top Flange to the Trident Mount with Tek Screws. There Are pre-drilled guide holes in the Trident Mount where the Tek Screws screw into the Top Flange.



Step 6 : Final Steps

If any piles were cut during installation due to refusal, ensure Those cut edges are coated with a cold galvanized paint.

Tip: Use a string or laser level to ensure all of the Flange Tops are aligned and level

Note: If the Trident Mounts are out of line or out of plumb they can be adjusted slightly. Use a sledge hammer and gently knock the Top Flange until the Trident Mount is in the correct position. There is only limited Adjustment. Excessive adjustment may result in damage to the Trident Mount.



TRIDENT MOUNT INSTALLATION CHECKLIST

ITEM	QTY	CHECKED
Trident Mount		
Flange Tops		
Alignment Rod		
Post Driver Attachment		
Piles		
Jack Hammer		
Power Drill		
Spare Drill Battery		
Magnetic Level		
Tape Measure		
String Line		
Hammer		
Sledge Hammer		
Ear Muffs / Ear Plugs		
Safety Glasses		
Gloves		
Cold Galvanized Spray Paint		
Generator (if needed)		
Fuel Can (if needed)		
Extention Cord		
Laser Level		
Appropriate Drill Bits		
9" Grinder & Spare Disk		
Construction Stakes		
General Tool Kit		
First Aid Kit		
Sunscreen		

Date : _____

Peron Checking : _____

Notes

TECHNICAL DATA SHEET

The CHIKOUSA Trident Mount utilizes ground breaking piling technology. The Trident Mounts unique, patented, geometric configuration is the most advanced ground attachment on the market today. The Trident Mounts configuration makes it a superior choice to conventional footer systems, with 3 cylinder piles locking into the ground resulting in an unmatched bearing capacity and pull out capacity when compared to other same class footer options. Ease of installation and time of installation are two of the biggest benefits of the Trident Mount.

TRIDENT MOUNT

Install Site : Soil
 Material : Q235 Steel
 Length : $10\frac{3}{16}$ "/260mm
 Treatment : Hot-Dip Galvanized
 Use : Ground Attachment
 Part# : CK-HT-103
 Quantity : 1

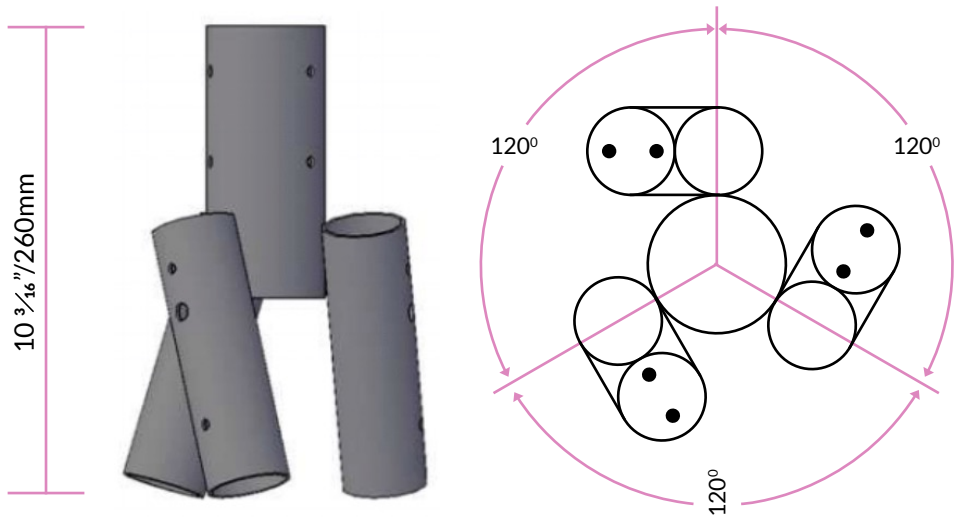

TOP FLANGE

Install Site : Top of Trident Mount
 Material : Q235 Steel
 Treatment : Hot-Dip Galvanized
 Length : $7\frac{13}{16}$ "/200mm
 Use : Top Insert for Trident
 Part# : CK-HT-105
 Quantity : 1

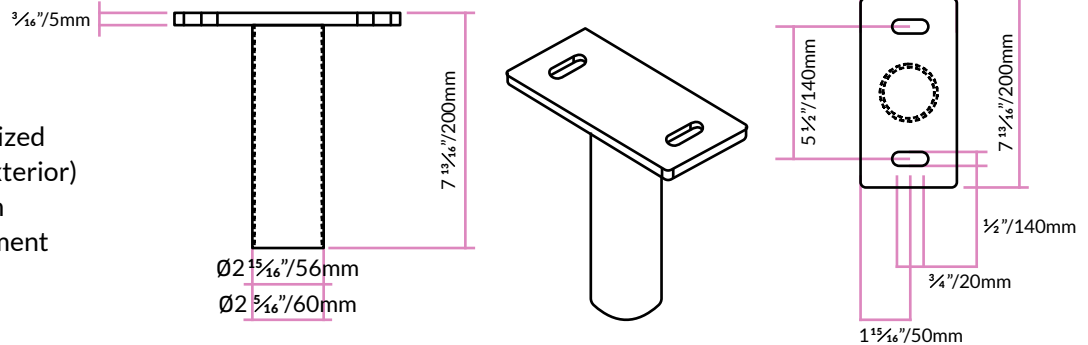

CYLINDER ROD

Material : Q235B Steel
 Treatment : Hot-Dip Galvanized
 Diameter : $1\frac{3}{16}$ "/40mm (exterior)
 Length : $47\frac{3}{16}$ "/1200mm
 Use : Ground Attachment
 Part# : CK-HT-107
 Quantity : 3

HARDWARE

M12 • 35mm bolt kit 2-QTY
 Screws 6.3 • 25mm 12-QTY

Overall Weight of All Components: 22LBS

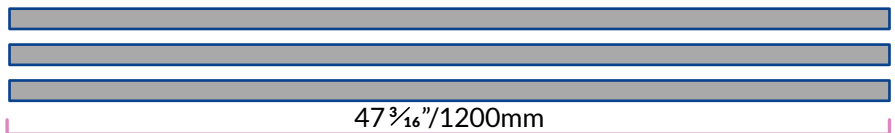

The Trident Mount has proven to be an easy and cost effective solution. The system can be used in a wide variety of soil types. The Trident Mount is fast and easy to install in most climates and geographic locations. Site disturbance is minimal and the mounts are removable, reusable, and recyclable. The superior geometric configuration of the Trident Mount supports both downward and uplift forces.

Sloping Sites: Eliminating the need for costly excavation and drainage on sloping sites which also prevents against erosion enabling the solar structure to run with the natural contour of the land.

Environmental Advantage: Minimal environmental impact (small footprint). Materials are non-polluting to the environment.

WORLDLEADING

M A N U F A C T U R E

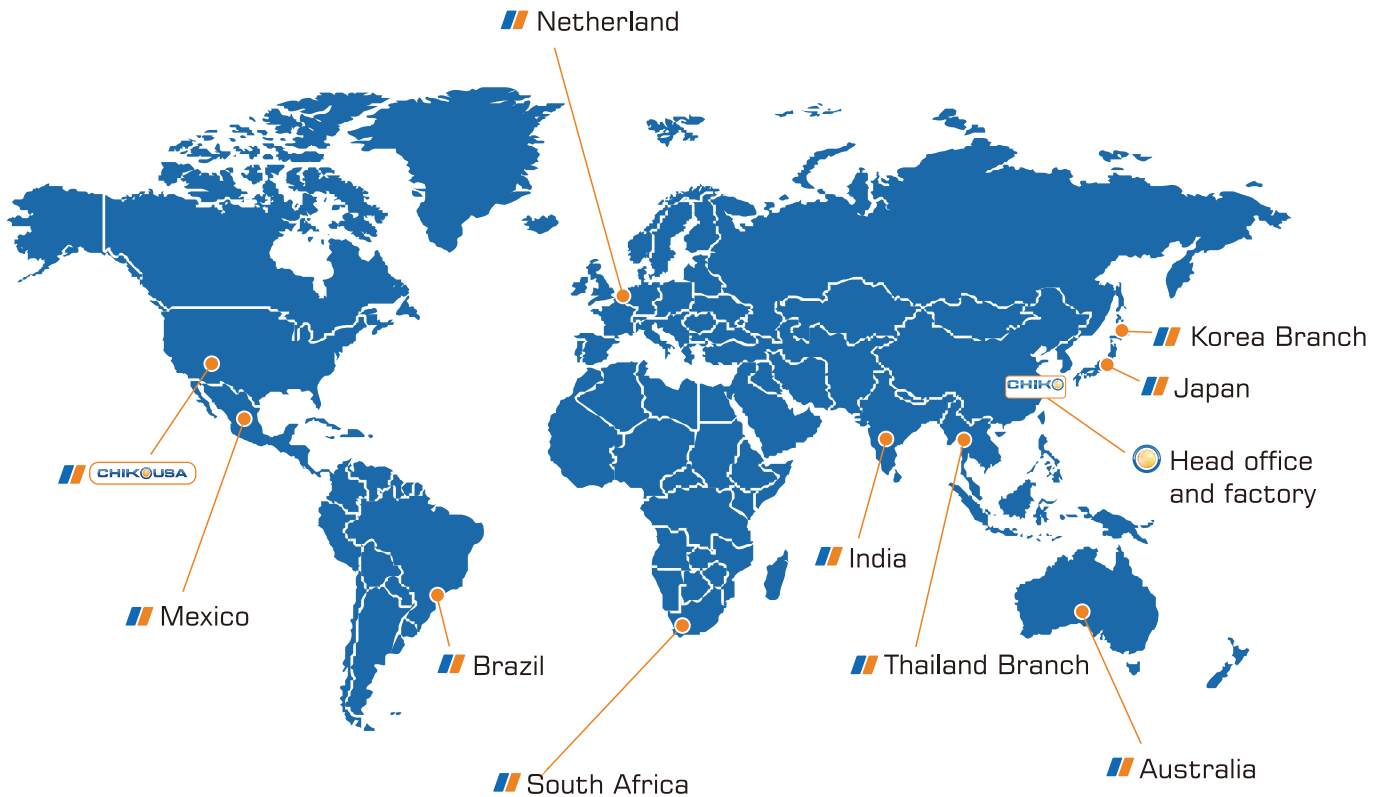

CHIKOUSA
RACKING MADE SIMPLE

Tel : 1-800-948-5390

Email : info@chikousa.com

www.chikousa.com



101 East Baseline Road
Buckeye, AZ 85326