 Suzhou Talesun Solar Technologies Co., Ltd.	Technical specifications	
TITLE: Installation manual for crystalline solar photovoltaic modules (IEC)	SPEC.NO	TS-ET-052
	REV	A2
	Effective Date	07-2020
		Page 1 of 29



TALESUN

INSTALLATION MANUAL

For crystalline solar photovoltaic modules

“According with IEC61215 edition 2 & IEC61730 standards”

Suzhou Talesun Solar Technologies Co., Ltd

Address: No. 1 Talesun Road, Changkun Industrial Park, Shajiabang Town, Changshu, Suzhou, Jiangsu Province, 215542, P.R.China

Website: www.talesun.com Email: sales@talesun.com Tel: +86 400 885 1098

 Suzhou Talesun Solar Technologies Co., Ltd.	Technical specifications	
	TITLE: Installation manual for crystalline solar photovoltaic modules (IEC)	SPEC.NO
	REV	A2
	Effective Date	07-2020
		Page 2 of 29

INDEX

1. INTRODUCTION
 - 1.1 PURPOSE OF THE MANUAL
 - 1.2 DISCLAIMER OF LIABILITY
 - 1.3 PRODUCTION IDENTIFICATION

2. SAFETY GUIDELINES
 - 2.1 GENERAL SAFETY GUIDELINES
 - 2.2 PRODUCT PRECAUTION
 - 2.3 TRANSPORT AND STORAGE SAFETY GUIDELINES

3. MECHANICAL INSTALLATION
 - 3.1 SELECTING THE LOCATION
 - 3.2 SELECTING THE PROPER SUPPORTING FRAME
 - 3.3 GENERAL INSTALLATION
 - 3.4 INSTALLATION METHOD

4. ELECTRICAL MOUNTING
 - 4.1 MODULE SELECTION
 - 4.2 SAFETY FACTOR
 - 4.3 GENERAL INSTALLATION
 - 4.4 GROUNDING

5. COMMISSION AND MAINTENANCE
 - 5.1 BLOCKING DIODES AND BYPASS DIODES
 - 5.2 TROUBLESHOOTING
 - 5.3 MAINTENANCE

6. TECHNICAL DATA

Suzhou Talesun Solar Technologies Co., Ltd

Address: No. 1 Talesun Road, Changkun Industrial Park, Shajiang Town, Changshu, Suzhou, Jiangsu Province, 215542, P.R.China

Website: www.talesun.com Email: sales@talesun.com Tel: +86 400 885 1098

 Suzhou Talesun Solar Technologies Co., Ltd.	Technical specifications	
	TITLE: Installation manual for crystalline solar photovoltaic modules (IEC)	SPEC.NO
	REV	A2
	Effective Date	07-2020
		Page 3 of 29

1 INTRODUCTION

1.1 PURPOSE OF THE MANUAL

This guide contains information on precautions to be used during the handling and installation of Suzhou Talesun Solar Technologies Co., Ltd photovoltaic modules along with technical instructions to be followed during installation, mounting, wiring and maintenance thereof. Talesun Solar Technologies Co., Ltd hereafter is referred to as “Talesun”. Any divergence from the contents of this manual during the handling, installation, or maintenance of Talesun’s products will render the warranty and any guarantees there under null and void.

Information for installers

- ✧ Installers must read and understand this manual before installation.
- ✧ Please ensure that installation, operation and maintenance of your photovoltaic system is only carried out by qualified persons able to carry out the technical procedures described in this manual, i.e. system planers, installers and maintenance personnel, and is carried out in accordance with all safety precautions in this manual and any and all applicable local codes. If you do not possess these qualifications, you may not carry out the work described herein except for cleaning.
- ✧ This manual and the instructions set forth herein are part of the product and should therefore be kept for the entire useful life of the solar installation.

Information for operators

- ✧ Keep these instructions safe for the entire useful life of the solar installation.
- ✧ Please contact your plant supplier for information concerning the formal requirements for solar systems. Please be sure to learn about directives and permit requirements from the responsible local authorities and energy providers prior to installation of the solar plant.
- ✧ We recommend that you insure your solar system against natural hazards (e.g. against lightning strikes).

1.2 DISCLAIMER OF LIABILITY

- ✧ These instructions are only valid for products of Talesun.
- ✧ The information in this manual is based on Talesun’s knowledge and experience and is believed to be reliable; but such information including product specification (without limitations) and suggestions do not constitute a warranty, expressed or implied. Talesun reserves the right to change the manual, the PV products, the specifications, or product information sheets without prior notice.
- ✧ Because of the use of this manual and the conditions or methods of installation, operation, use and maintenance of photovoltaic products are beyond Talesun’s control, Talesun assumes no liability for damage, loss, or expense arising out of or in any way connected with such installation, operation, use or maintenance. Talesun assumes no responsibility extending beyond the functional capability and safety of the modules. This manual is only for reference.
- ✧ No license is granted by implication or otherwise under any patent or patent rights.
- ✧ Special module’s installation according to the module’s specification or contract terms.
- ✧ If your questions are not adequately addressed in this manual, please first contact your system supplier. You can find

Suzhou Talesun Solar Technologies Co., Ltd

Address: No. 1 Talesun Road, Changkun Industrial Park, Shajiabang Town, Changshu, Suzhou, Jiangsu Province, 215542, P.R.China

Website: www.talesun.com Email: sales@talesun.com Tel: +86 400 885 1098

 Suzhou Talesun Solar Technologies Co., Ltd.	Technical specifications	
	TITLE:	SPEC.NO
Installation manual for crystalline solar photovoltaic modules (IEC)	REV	TS-ET-052
	Effective Date	A2
		07-2020
		Page 4 of 29

more information on our website www.talesun.com.

1.3 PRODUCTION IDENTIFICATION

Each module has three labels that provide the following information:

- ✧ Nameplate: describes the product type; rated power, rated current, rated voltage, open circuit voltage, short circuit current, all as measured under standard test conditions; weight, dimension etc.; the maximum system voltage is 1000 volts or 1500 volts DC is shown on the nameplate. Maximum fuse rating is also shown.
- ✧ dimensional Bar code (1/2 dimensional way) : The serial number has 16 digits. There are two bar codes on each module. One is permanently attached to the interior of the module and is visible when viewing the front of the module, and another is stuck to the rear side of the module.
- ✧ Removing the Nameplate will make the Talesun warranty void.

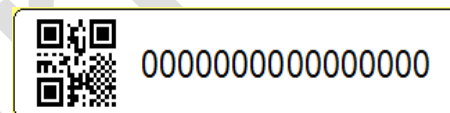

2 SAFETY GUIDELINES

2.1 GENERAL SAFETY GUIDELINES

DANGER! Danger due to electric shock!



All installations must be performed in compliance with all applicable regional and local codes, or other national or international electrical standards as applicable.

- ✧ A solar module generates electricity and voltage even at low intensity of illumination. So it's need to avoid contacting original charged .Paying attention to median electric circuit before a transition or disconnected.
- ✧ Physically disconnecting contacts in a live electrical circuit can cause arcing, resulting in grave or mortal injury. The severity increases when several modules are connected in series.
- ✧ Cover the solar modules with opaque material for the entire duration of assembly. Only then is the module reliably de-energized.
- ✧ Never disconnect plugs when under load. Be aware that even without the presence of daylight, residual charge may still be present in the plant. Ensure that the modules are first disconnected from the inverter prior to opening any contacts in the solar installation.
- ✧ Artificially concentrated sunlight shall not be directed on the module. Solar modules produce electrical energy when light shines on their front surface. The DC voltage may exceed 30V. Contact with a DC voltage of 30V or more is potentially hazardous.
- ✧ In the case of module or phase voltages of more than 120 V, the extra-low voltage range is left. Undertake the necessary protective and precautionary measures.
- ✧ Do not insert electrically conductive parts into the plugs and junction box. Do not touch the contacts or exposed terminals.
- ✧ Keep children and unauthorized persons away from the modules.
- ✧ In case of damaged modules or operational errors of the solar array, always contact your installer or Talesun Technical

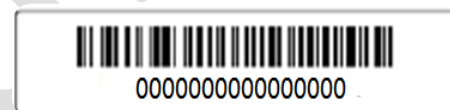

Suzhou Talesun Solar Technologies Co., Ltd

Address: No. 1 Talesun Road, Changkun Industrial Park, Shajiang Town, Changshu, Suzhou, Jiangsu Province, 215542, P.R.China

Website: www.talesun.com Email: sales@talesun.com Tel: +86 400 885 1098

 Suzhou Talesun Solar Technologies Co., Ltd.	Technical specifications	
	TITLE: Installation manual for crystalline solar photovoltaic modules (IEC)	SPEC.NO
	REV	A2
	Effective Date	07-2020
		Page 5 of 29

Customer Service.

- ✧ Do not wear metallic ornaments or metallic devices while installing or troubleshooting photovoltaic systems. Please wear suitable PPE
- ✧ Please don't put out the fire with water if there is a fire.
- ✧ Please don't install or process components when the components are wet or the wind blows.

WARNING! Danger of injury due to broken glass! Risk of injury due to falling modules!



The modules are primarily made of glass and must therefore be handled with appropriate caution.

- ✧ In order to ensure safe mounting, familiarize yourself with all applicable national regulations for work safety and accident prevention.
- ✧ Wear suitable protective clothing (e.g. safety shoes, protective gloves) in order to prevent injuries..notice:the voltage of protective clothing must be greater than 1500V for talesun's TP660M(H), TP660P(H),the H series of components.
- ✧ If the front glass is broken, or the back sheet is torn, contact with any module surface or the frame can cause electric shock.

2.2 PRODUCT PRECAUTION

- ✧ Do not attempt to disassemble the modules.
- ✧ Do not remove any attached nameplates or components from the modules.
- ✧ Do not open the junction box under any circumstances.
- ✧ Please don't connect or plug connector if the joint is contaminated.
- ✧ Only carry out modifications to the modules that have been confirmed by Talesun in writing in advance.
- ✧ Do not carry out any extra drilling (e.g. for fasteners) on the modules.
- ✧ Use only insulated tools that are approved for work on electrical installations.
- ✧ Do not use light concentrators (e.g. mirrors or lenses) to attempt to increase the capacity of the module. The module may be damaged. This also voids the warranty.
- ✧ It is forbidden to extrude, collision, toughen the glass of module



2.3 TRANSPORT AND STORAGE SAFETY GUIDELINES

Inappropriate transport and installation may break the module. To prevent damage of the modules:

- ✧ Transport the modules in their original packaging until installation.
- ✧ Store the modules securely in cool and dry rooms. The packaging is not weather-resistant!
- ✧ Protect the modules against scratches and other damage, especially from impact at the edges or improper storage.
- ✧ Ensure modules do not bow under their own weight.
- ✧ Do not rest a module unprotected on its edges. This can damage the module and the frame.
- ✧ Do not lift or move the modules using the cables or at the junction box under any circumstances!
- ✧ Do not set the modules down hard on any surface.



Suzhou Talesun Solar Technologies Co., Ltd

Address: No. 1 Talesun Road, Changkun Industrial Park, Shajiang Town, Changshu, Suzhou, Jiangsu Province, 215542, P.R.China

Website: www.talesun.com Email: sales@talesun.com Tel: +86 400 885 1098

 Suzhou Talesun Solar Technologies Co., Ltd.	Technical specifications	
	TITLE: Installation manual for crystalline solar photovoltaic modules (IEC)	SPEC.NO
	REV	A2
	Effective Date	07-2020
		Page 6 of 29

- ✧ Do not subject the module surfaces to mechanical stress.
- ✧ Do not stand on the modules.
- ✧ Do not drop or place objects on the modules.

3 MECHANICAL INSTALLATION

3.1 SELECTING THE LOCATION

- ✧ The modules are certified according to the norm IEC 61215 and others for safe operation in moderate climates. The operator needs to consider the effect of the high altitude on the operation of the module, when the modules are installed at high altitude.
- ✧ Do not expose the modules to chemicals.
- ✧ Do not place the modules in standing water. The projection grade of the junction box is IP67.
- ✧ Do not install the modules near flammable gases and vapors (e.g. gas containers) or near open flames and flammable materials. Solar modules are not explosion-proof operating equipment.
- ✧ If there is exposure to salt (i.e., marine environments) and sulfur (i.e., sulfur sources, volcanoes), there is a risk of corrosion. It's not recommended to install the modules, when the distance is less than 100m ; and it's recommended to install the modules with the anti-salt function, when the distance is between 100m and 1km.
- ✧ A module is considered shade-free when it is entirely unshaded throughout the year (e.g. by buildings, chimneys, trees). Even partial shading of the modules (e.g. by overhead lines, dirt, snow) should be avoided.

3.2 SELECTING THE PROPER SUPPORTING FRAME

Always observe the instructions and safety precautions included with the support frames to be used with the modules.

Install each module to a mounting structure:

- ✧ That is made of durable, corrosion-resistant and UV-resistant material.
- ✧ That can transfer forces on the module to the assembly substructure.
- ✧ That ensures that no mechanical stress (e.g. caused by vibrations, twisting or expansion) is generated on the module.
- ✧ That ensures sufficient back ventilation of the module.
- ✧ That ensures long term stability.
- ✧ That will not give rise to galvanic corrosion in case of direct metal contact (i.e. grounding lead, screws, washers, etc.)
- ✧ That allows for strain-free expansion and contraction due to natural ambient temperature variations.

3.3 GENERAL INSTALLATION

Modules connected in series should be installed at the same orientation and angle. Different orientations or angles may cause a loss of power output due to the change in sunlight exposure.

- ✧ When developing the final layout of photovoltaic system, consider keeping suitable access to allow the maintenance and inspection works. To minimize risk in the event of an indirect lightning strike, avoid forming loops when designing the system.
- ✧ The modules may be installed in landscape or portrait format.

Suzhou Talesun Solar Technologies Co., Ltd

Address: No. 1 Talesun Road, Changkun Industrial Park, Shajiang Town, Changshu, Suzhou, Jiangsu Province, 215542, P.R.China

Website: www.talesun.com Email: sales@talesun.com Tel: +86 400 885 1098

 Suzhou Talesun Solar Technologies Co., Ltd.	Technical specifications	
	TITLE:	SPEC.NO
Installation manual for crystalline solar photovoltaic modules (IEC)	REV	TS-ET-052
	Effective Date	A2
		07-2020
		Page 7 of 29

- ✧ Two pieces of component minimum distance is 10mm.
- ✧ Never plug the drain selecting installation way.
- ✧ Install the module in such a way that the junction box is positioned in the upper area of the module and the wires hang downwards.
- ✧ The optimal tilt angle of the module depends on the respective latitude. We recommend a photovoltaic simulation tool to ensure the optimal orientation.

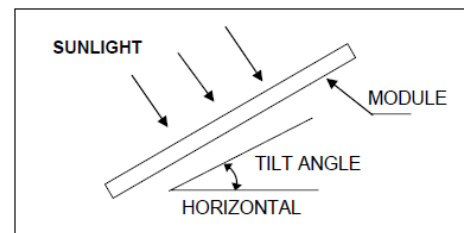

Ground mount

- ✧ Select the height of the mounting system to prevent the lowest edge of the module from being covered by snow for a long time in winter in areas that experience heavy snowfalls.
- ✧ In addition, assure the lowest portion of the module is placed high enough so that it is not shaded by plants or trees or damaged by sand and stones driven by wind.

Roof mount

- ✧ When installing a module on a roof or building, ensure that it is securely fastened and cannot fall as a result of wind or snow loads. Maintain safe working area on roof edge and component array
- ✧ Provide adequate ventilation under a module for cooling; the recommended standoff height is more than 115mm. Clearance of 10 mm or more between modules is required to allow for thermal expansion of the frames. If other mounting means are employed this may affect the UL Listing or the fire class rating.
- ✧ For roof mounting applications the assembly is to be mounted over a fire resistant roof covering rated for the application. Talesun modules have been listed as Class C according to IEC standard.
- ✧ Any roof penetration required to mount the module must be properly sealed to prevent leaks.
- ✧ In some cases, a special support frame may be necessary.
- ✧ The roof installation of solar modules may affect the fireproofing of the building construction.
- ✧ Do not install modules on a roof or building during strong winds to prevent accidents.
- ✧ All module support structures used to support PV modules at correct tilt angles should be wind and snow load rated by appropriate local and civil codes prior to installation.

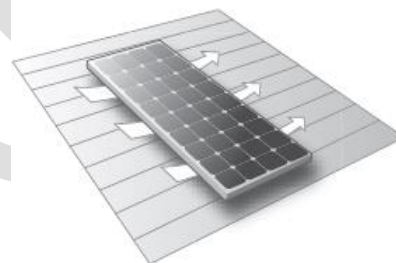

Pole mount

- ✧ When installing a module on a pole, choose a pole and module mounting structure that will withstand anticipated winds for the area.

3.4 INSTALLATION METHOD

(a) Frame Holes Mounting

Modules must be securely attached to the mounting structure using four pre-drilled mounting holes in the frame.

- ✧ Modules should be bolted to support structures through mounting holes located in the frame's back flanges only. Do

Suzhou Talesun Solar Technologies Co., Ltd

Address: No. 1 Talesun Road, Changkun Industrial Park, Shajiang Town, Changshu, Suzhou, Jiangsu Province, 215542, P.R.China

Website: www.talesun.com Email: sales@talesun.com Tel: +86 400 885 1098

 TALESUN	Suzhou Talesun Solar Technologies Co., Ltd.	Technical specifications	
TITLE: Installation manual for crystalline solar photovoltaic modules (IEC)		SPEC.NO	TS-ET-052
		REV	A2
		Effective Date	07-2020
		Page 8 of 29	

not drill additional holes. Doing so will void the warranty.

- ✧ Each module must be securely fastened at a minimum of 4 points. If additional wind or snow loads are anticipated for this installation, additional mounting points should be used. System designer and installer are responsible for load calculations and for proper design of support structure.

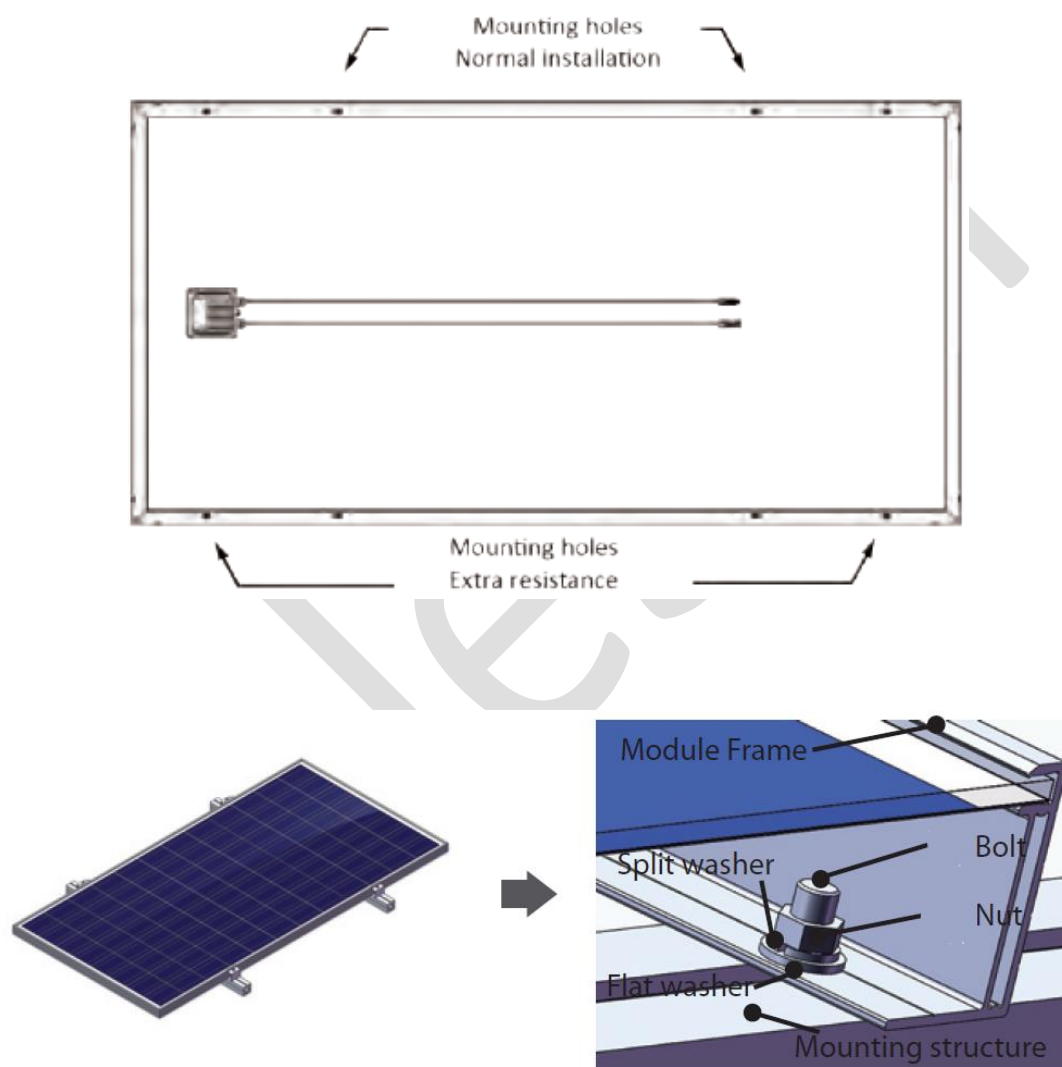

- ✧ Use appropriate corrosion-proof fastening materials. All mounting hardware (bolt/split washer/flat washer/nut) should be stainless steel M8 size. the parts used in contact with the frame are 20-24mm in diameter, with a thickness of more than 1.8mm. A flat washer with a diameter of 16mm should be used for the large cavity 35 bezels of model 72.
- ✧ Follow mounting guidelines recommended by the PV mounting supplier. The mounting design must be certified by a

Suzhou Talesun Solar Technologies Co., Ltd

Address: No. 1 Talesun Road, Changkun Industrial Park, Shajiang Town, Changshu, Suzhou, Jiangsu Province, 215542, P.R.China

Website: www.taesun.com Email: sales@taesun.com Tel: +86 400 885 1098
8 / 29

 Suzhou Talesun Solar Technologies Co., Ltd.	Technical specifications	
TITLE: Installation manual for crystalline solar photovoltaic modules (IEC)	SPEC.NO	TS-ET-052
	REV	A2
	Effective Date	07-2020
		Page 9 of 29

registered professional engineer.

- ✧ The mounting design and procedures shall comply with local codes and all authorities having jurisdiction.
- ✧ Use a torque wrench for installation. Tightening torques should be within 10~17 Nm for M8 coarse thread bolts, depending on bolt quality class.
- ✧ Ensure that the drainage openings of the frame are left open following installation to allow water runoff. This prevents frost damage.
- ✧ Install the module in such a way that rainwater and snowmelt can run off freely to avoid standing water or puddling.
- ✧ this resistance value can decrease if modules are not mounted following the instructions above.

(b) Clamping installation

Modules can be installed with clamps. Modules must be securely attached to the mounting structure with four clamps **or** more on the long frame.

- ✧ The modules must be properly secured to their support so that they can withstand live load condition, including wind uplift, to the pressure they have been certified for. It's the installer's responsibility to ensure the clamps used to secure the modules are strong enough.
- ✧ The modules are not subject to wind or snow loads exceeding the maximum permissible loads.
- ✧ The module clamps which are used must not come into contact with the front glass and must not deform the frame. Avoid shadowing effects from the module clamps. Drain holes in the module frame must not be closed or obscured by the clamps.

Attachment to the long frame

- ✧ The module installed with clamps on the front frame for 2400Pa load and 5400Pa load (see the following picture), and refer to the following table for different value of "A" and "B".

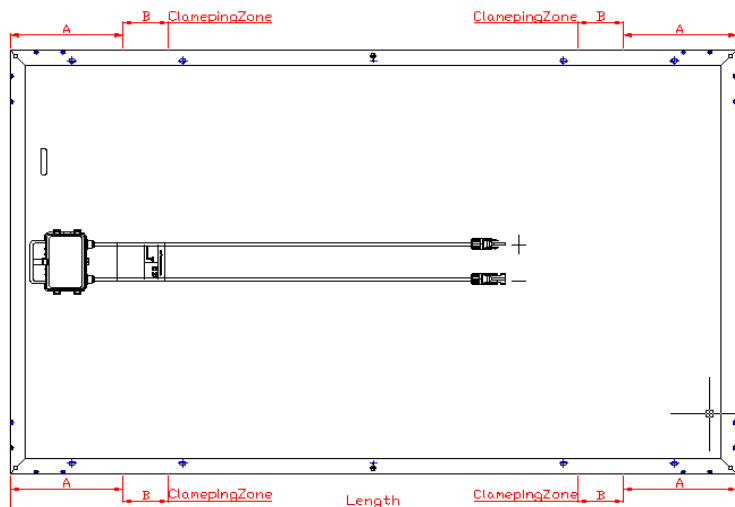

Suzhou Talesun Solar Technologies Co., Ltd

Address: No. 1 Talesun Road, Changkun Industrial Park, Shajiang Town, Changshu, Suzhou, Jiangsu Province, 215542, P.R.China

Website: www.talesun.com Email: sales@talesun.com Tel: +86 400 885 1098

 Suzhou Talesun Solar Technologies Co., Ltd.	Technical specifications	
	TITLE: Installation manual for crystalline solar photovoltaic modules (IEC)	SPEC.NO
	REV	A2
	Effective Date	07-2020
		Page 10 of 29

Module Type	Module Dimension Length*Width*Thickness	Load	A	
			Distance from module edge to clamping zone	B Clamping zone
TP 678 series	2140mm*1002mm*40mm	2400Pa	420mm	100mm
		5400Pa	420mm	100mm
	2140mm*1002mm*35mm	2400Pa	420mm	100mm
		5400Pa	420mm	100mm
TP672 series	1960mm*992mm*40mm	2400Pa	400mm	100mm
		5400Pa	400mm	100mm
	1960mm*990mm*40mm	2400Pa	400mm	100mm
		5400Pa	400mm	100mm
	1960mm*990mm*45mm	2400Pa	400mm	100mm
		5400Pa	400mm	100mm
	1960mm*990mm*50mm	2400Pa	400mm	100mm
		5400Pa	400mm	100mm
TP660 series	1979mm*1002mm*35mm	2400Pa	400mm	100mm
		5400Pa	400mm	100mm
	1960mm*992mm*35mm	2400Pa	400mm	100mm
		5400Pa	400mm	100mm
	1650mm*992mm*35mm	2400Pa	250mm	100mm
		5400Pa	250mm	100mm
	1650mm*992mm*40mm	2400Pa	250mm	100mm
		5400Pa	250mm	100mm
	1640mm*990mm*35mm	2400Pa	250mm	100mm
		5400Pa	250mm	100mm
	1640mm*990mm*40mm	2400Pa	250mm	100mm
		5400Pa	250mm	100mm
1665mm*1002mm*35mm	2400Pa	250mm	100mm	
	5400Pa	250mm	100mm	
TP648 series	1324mm*990mm*35mm	2400Pa	200mm	100mm
		5400Pa	200mm	100mm
	1324mm*990mm*40mm	2400Pa	200mm	100mm
		5400Pa	200mm	100mm

Suzhou Talesun Solar Technologies Co., Ltd

Address: No. 1 Talesun Road, Changkun Industrial Park, Shajiang Town, Changshu, Suzhou, Jiangsu Province, 215542, P.R.China

Website: www.talesun.com Email: sales@talesun.com Tel: +86 400 885 1098

 Suzhou Talesun Solar Technologies Co., Ltd.	Technical specifications	
	TITLE: Installation manual for crystalline solar photovoltaic modules (IEC)	SPEC.NO
	REV	A2
	Effective Date	07-2020
		Page 11 of 29

Fixture installation allows rang

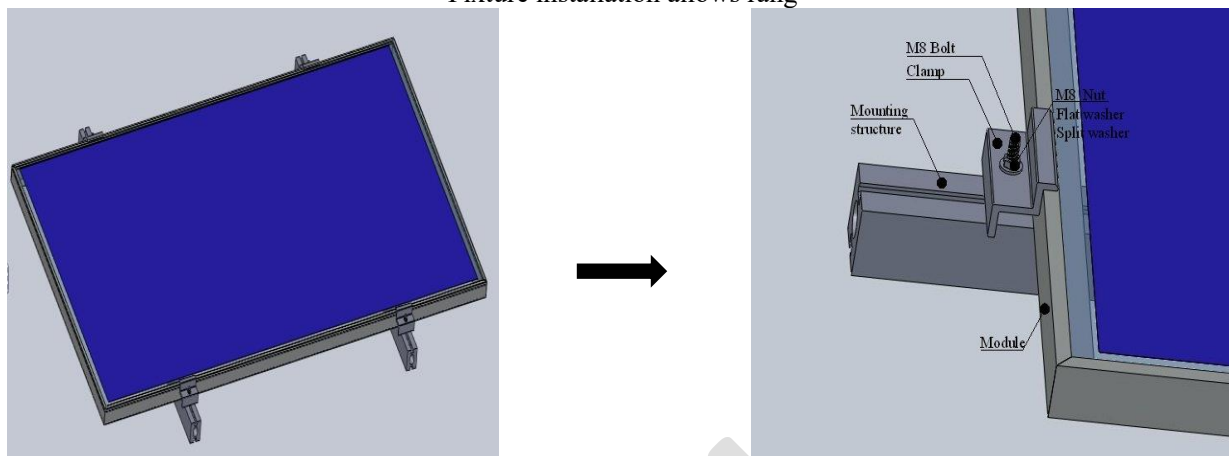

- ✧ Use a torque wrench for installation, and the compression for each clamps is not strong to avoid potential damages to module frames. The recommended maximum compression for each clamp is 20MPa (2900PSI).
- ✧ The module mounting structure must be made of durable, corrosion-resistant and UV-resistant material. All mounting hardware (bolt/flat washer/split washer/nut) should be stainless steel M8 size.
- ✧ The minimum recommended length for each clamp is 50mm.
- ✧ The modules have been designed to resist a static load of 2400Pa , and the resistance value can decrease if modules are not mounted following the instruction above.
- ✧ This manual is just for reference. Customer can select the corresponding installation manual based on the purchased module.
- ✧

4 ELECTRICAL INSTALLATION

4.1 MODULE SELECTION

Only connect modules of the same type, same configurations and same power class in the same system. This is the only way to achieve optimal yields.

4.2 SAFTY FACTOR

Under normal conditions, a photovoltaic module may experience conditions that produce more current and/or voltage than reported at Standard Test Conditions. Accordingly, the values of ISC and VOC marked on modules should be multiplied by a factor of 1.25 when determining component voltage ratings, conductor capacities, fuse sizes and size of controls connected to the module output.

Alternatively, all valid national regulations for the installation of electrical systems are to be applied.

Suzhou Talesun Solar Technologies Co., Ltd

Address: No. 1 Talesun Road, Changkun Industrial Park, Shajiang Town, Changshu, Suzhou, Jiangsu Province, 215542, P.R.China

Website: www.talesun.com

Email: sales@talesun.com

Tel: +86 400 885 1098

 Suzhou Talesun Solar Technologies Co., Ltd.	Technical specifications	
	TITLE: Installation manual for crystalline solar photovoltaic modules (IEC)	SPEC.NO
	REV	A2
	Effective Date	07-2020
		Page 12 of 29

Installer need to pay more attention to avoid the PID phenomenon, when installing the electrical system. Refer to Section 690-8 of the National Electric Code for an additional multiplying factor of 1.25(for a total of 1.56) which may be applicable, and a correction factor for an open circuit (see Table 1 below) for sizing conductors and fuses is applicable, as described in section 690-8 of U.S. NEC.

Table 1: Low temperature correction factors table for open-circuit voltage

Lowest Expected Ambient Temperature (°C/°F)	Correction Factor
24 to 20/76 to 68	1.02
19 to 15/67 to 59	1.04
14 to 10/58 to 50	1.06
9 to 5/49 to 41	1.08
4 to 0/40 to 32	1.10
-1 to -5/31 to 23	1.12
-6 to -10/22 to 14	1.14
-11 to -15/13 to 5	1.16
-16 to -20/4 to -4	1.18
-21 to -25/-5 to -13	1.20
-26 to -30/-14 to -22	1.21
-31 to -35/-23 to -31	1.23
-36 to -40/-32 to -40	1.25

4.3 GENERAL INSTALLATION

- ✧ Before installing modules, contact the appropriate authorities to determine permissions, installation and inspection requirements to follow that apply to your site and installation.
- ✧ Check applicable building codes to ensure that the construction or structure (roof, facade, support, etc.) where the modules are being installed is strong enough to support the weight of the modules and all other system components.
- ✧ When high current is needed, several PV modules can be connected in parallel. The total current is equal to the sum of their respective currents. Each component (or series of components in series) shall be provided with the specified maximum current fuse. The recommended number of parallel components is 1.
- ✧ When a high voltage needs to be obtained, several PV modules can be connected in series with the total voltage equal to the sum of their voltages. However, the maximum system voltage must be lower than the highest certified voltage and the maximum input voltage for inverters and other electrical equipment in the installed system. The maximum number of modules in series is $(N) = \text{System } V_{\text{max}} / \{V_{\text{oc}} (\text{at STC}) \times [1 + (t - 25) * K_v]\}$, where:
 - N: Number of modules in series
 - V_{oc} (at STC): Open circuit voltage of each module (refer to product label or data sheet)
 - K_v: Thermal coefficient of open circuit voltage for the module (refer to data sheet)
 - t: The lowest expected ambient temperature
- ✧ Connect the appropriate number of components according to the voltage specifications of the inverter used by the system. Even in the worst local temperature conditions, the connected components produce voltages that are not higher than the allowable voltage values of the system.

Suzhou Talesun Solar Technologies Co., Ltd

Address: No. 1 Talesun Road, Changkun Industrial Park, Shajiang Town, Changshu, Suzhou, Jiangsu Province, 215542, P.R.China

Website: www.talesun.com Email: sales@talesun.com Tel: +86 400 885 1098

 Suzhou Talesun Solar Technologies Co., Ltd.	Technical specifications	
	TITLE: Installation manual for crystalline solar photovoltaic modules (IEC)	SPEC.NO
	REV	A2
	Effective Date	07-2020
		Page 13 of 29

- ✧ The components of similar electrical properties are proposed to be connected on the same string to reduce the array mismatch effect.
- ✧ Use special solar cable and suitable plugs only (wiring should be placed in conduit that is sunlight-resistant or, if exposed, should be sunlight-resistant) in accordance with local fire, building and electrical codes. Ensure that they are in perfect electrical and mechanical condition.
- ✧ Only use solar cables as connection cables. Use connectors of the same type and manufacturer within a solar system, and compatible connectors to connect the inverter. During the installation, disassembly, maintenance and any other related processes of cables and connectors, the force applied between cables and connectors shall not be more than 90N, so as to avoid improper connection or damage of connectors and cables caused by human factors, affecting the electrical safety or service life of products.
- ✧ Ensure that all electrical components are in a proper, dry and safe condition. In this way you avoid electrical short-circuits or dangerous contact voltages due to defective or damaged cables.
- ✧ Always avoid mechanical stressing of the connection cables.
- ✧ Ensure a tight connection between the individual connectors (especially to the inverter). Make sure they click together properly.

4.4 GROUNDING

- ✧ The module frame must be properly grounded. The grounding wire must be properly fastened to the module frame to assure good electrical contact. Use the recommended type, or an equivalent, connector for this wire.
- ✧ Polarity negative ground of the inverter in the system is able to effectively avoid the PID phenomenon of the module in addition, and professional person is needed to undertake the polarity negative ground operation of the inverter.
- ✧ If the support frame is made of metal, the surface of the frame must be electroplated and have excellent conductivity.
- ✧ Grounding clip assembly (TYPE: TYCO ELECTRONICS 1954381-2).
- ✧ The minimum bending radius of cable is 43mm

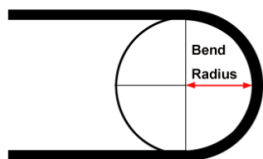
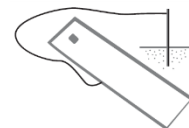

Running the wrong way

Running the right way

Wire selection and preparation:

The grounding clip accepts solid uninsulated copper wire sizes 10 or 12 AWG. The wire must not be nicked, cut, or scraped. There is no preparation required.

Suzhou Talesun Solar Technologies Co., Ltd

Address: No. 1 Talesun Road, Changkun Industrial Park, Shajiang Town, Changshu, Suzhou, Jiangsu Province, 215542, P.R.China

Website: www.talesun.com

Email: sales@talesun.com

Tel: +86 400 885 1098

 Suzhou Talesun Solar Technologies Co., Ltd.	Technical specifications	
TITLE: Installation manual for crystalline solar photovoltaic modules (IEC)	SPEC.NO	TS-ET-052
	REV	A2
	Effective Date	07-2020
		Page 14 of 29

Spacing:

Care must be used to avoid interference between adjacent grounding clips and other components for removal of the grounding clip.

Removal:

The wire can be removed from the grounding clip when the slider is disengaged (slider and screw are exposed). The screw must be loosened before the grounding clip can be removed from the frame. The grounding clip can be reused up to 5 times after proper removals (the 8--32 screw and hex nut or Keps nut can be reused; however, the thread-cutting screw must be replaced). The thread-cutting screw cannot be reused after removing the grounding clip from the frame.

Repair:

The grounding clip is not repairable. Discard any defective or damaged grounding clips.

Tooling:

A No. 2 cross--recessed screwdriver must be used to secure (and remove) the screw of the grounding clip to (and from) the frame. For the grounding clip with the 8--32 screw and hex nut or Keps nut, a 3/8--in. wrench must be used to secure (and remove) the nut of the grounding clip to (or from) the frame. The recommended screw tightening torque is 1.7+0.5/-0.2Nm (15+4.4/-1.7 in.-lbs).

The slider can be engaged manually or channel lock pliers can be used to engage the slider. A flat--head screwdriver must be used to disengage the slider.

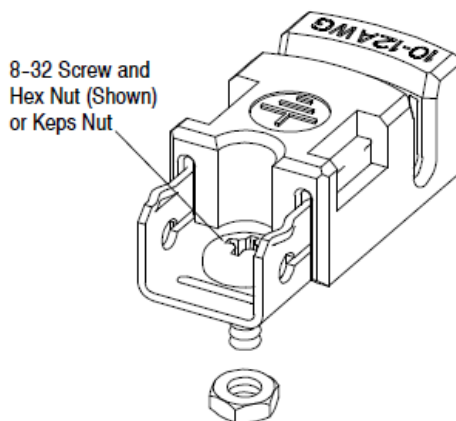

Suzhou Talesun Solar Technologies Co., Ltd

Address: No. 1 Talesun Road, Changkun Industrial Park, Shajiang Town, Changshu, Suzhou, Jiangsu Province, 215542, P.R.China

Website: www.talesun.com Email: sales@talesun.com Tel: +86 400 885 1098

 TALESUN	Suzhou Talesun Solar Technologies Co., Ltd.	Technical specifications	
TITLE: Installation manual for crystalline solar photovoltaic modules (IEC)		SPEC.NO	TS-ET-052
		REV	A2
		Effective Date	07-2020
		Page 15 of 29	

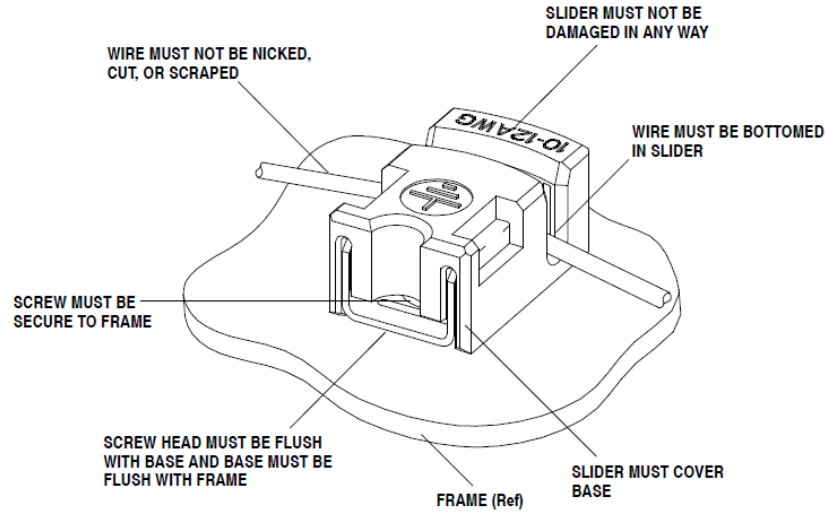

Mounting

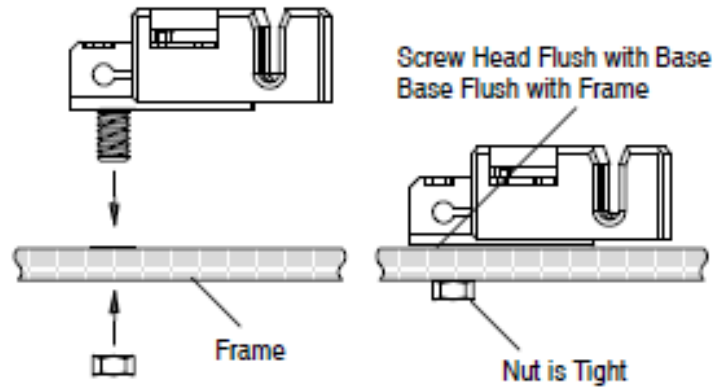

Suzhou Talesun Solar Technologies Co., Ltd

Address: No. 1 Talesun Road, Changkun Industrial Park, Shajiang Town, Changshu, Suzhou, Jiangsu Province, 215542, P.R.China

Website: www.talesun.com

Email: sales@talesun.com

Tel: +86 400 885 1098

 Suzhou Talesun Solar Technologies Co., Ltd.	Technical specifications	
TITLE: Installation manual for crystalline solar photovoltaic modules (IEC)	SPEC.NO	TS-ET-052
	REV	A2
	Effective Date	07-2020
		Page 16 of 29

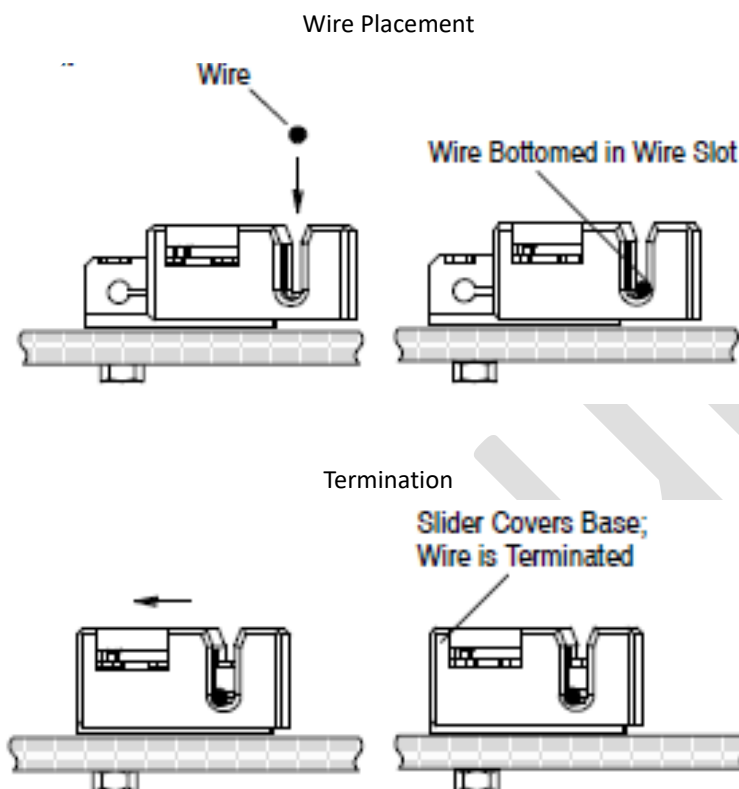

5 COMMISSION AND MAINTENANCE

5.1 BLOCKING DIODES AND BYPASS DIODES

- ✧ Blocking diodes prevent current flowing from the battery to the module when no electricity is being generated. It is recommended to use blocking diodes when a charging regulator is not used. Your specialist dealer can advise you regarding the suitable types.
- ✧ In systems with more than two modules in series, high reverse current can flow through cells that are shaded partially or outright when part of a module is shaded and the rest is exposed to the sun. These currents can cause the affected cells to get very hot and could even damage the module. To protect module from such high reverse currents, by-pass diodes are used in modules. All modules rated greater than 55 Watt have bypass diodes already integrated in the junction box. In the unlikely event of diode failure, it can be easily replaced; however, doing so will void warranty unless this exchange is made by an authorized person.
- ✧ Protect yourself from electric shocks while debugging or maintaining the solar power system.

Suzhou Talesun Solar Technologies Co., Ltd

Address: No. 1 Talesun Road, Changkun Industrial Park, Shajiabang Town, Changshu, Suzhou, Jiangsu Province, 215542, P.R.China

Website: www.talesun.com Email: sales@talesun.com Tel: +86 400 885 1098

 Suzhou Talesun Solar Technologies Co., Ltd.	Technical specifications	
	TITLE: Installation manual for crystalline solar photovoltaic modules (IEC)	SPEC.NO
	REV	A2
	Effective Date	07-2020
		Page 17 of 29

5.2 TROUBLESHOOTING



DANGER! Life danger due to electric shock!

- ✧ Please do not attempt to correct problems on your own!
- ✧ In case of problems or damaged modules (for example, glass breakage, damaged cables) please contact your installer or the Talesun Technical Customer Service.

5.3 MAINTENANCE

Talesun modules are built to last and require minimal maintenance. The dirt is typically washed away by rain. However, rain may not adequately clear more stubborn grime (i.e. pollen, vegetation, bird droppings, etc.). Such soiling which shades the active area of the module can lead to a reduction in the system's performance. Talesun recommends the following maintenance in order to ensure optimum performance of the module:

- ✧ Clean the glass surface of the module as necessary. Always use water and a soft sponge or cloth for cleaning. A mild, non-abrasive cleaning agent can be used to remove stubborn dirt.
- ✧ Check the electrical and mechanical connections every six months to verify that they are clean, secure and undamaged.
- ✧ If any problem arises, have them investigated by a competent specialist. Attention: observe the maintenance instructions for all components used in the system, such as support frames, charging regulators, inverters, batteries etc

Please download SPEC at <http://www.talesun.com/> if need

6 Technical data(156.75 cell)

Type 1000v	TP672P-***	TP672M-***	TP660P-***	TP660M-***
Type 1500v	TP672P (H) -***	TP672M (H) -***	TP660P (H) -***	TP660M (H) -***
Power	***=300-385 in 5W steps	***=325-415 in 5W steps	***=255-320 in 5W steps	***=270-345 in 5W steps
Type	6 inch *6 inch /72cells/ Poly-crystalline	6 inch *6 inch /72cells/ Mono-crystalline	6 inch *6 inch /60cells/ Poly-crystalline	6 inch *6 inch /60cells/ Mono-crystalline
Dimension [mm]	1960×992×35	1960×992×35	1650×992×35	1650×992×35
Weight [kg]	22	22	18.5	18.5

Suzhou Talesun Solar Technologies Co., Ltd

Address: No. 1 Talesun Road, Changkun Industrial Park, Shajiang Town, Changshu, Suzhou, Jiangsu Province, 215542, P.R.China

Website: www.talesun.com Email: sales@talesun.com Tel: +86 400 885 1098



TITLE:
Installation manual for crystalline solar photovoltaic modules (IEC)

SPEC.NO TS-ET-052

REV A2

Effective Date 07-2020

Page 18 of 29

Max. system voltage [V]	1500/1000
Junction box	Protection class IP 67 with bypass diode
Connector	MC3 or MC4 or MC3 compatible type or MC4 compatible type
Flammability rating	C
Application class	A
Static load [Pa]	5400

Module	Maximum System Voltage(V)	Pmax (W)	Vmpp (V)	Impp (A)	Voc (V)	Isc (A)	Fuse Rating (A)
TP672P-385	1000(IEC)	385	41	9.42	48.2	9.95	20
TP672P-380	1000(IEC)	380	40.7	9.36	48	9.89	
TP672P-375	1000(IEC)	375	40.4	9.3	47.8	9.83	
TP672P-370	1000(IEC)	370	40.1	9.24	47.6	9.77	
TP672P-365	1000(IEC)	365	39.8	9.18	47.4	9.71	
TP672P-360	1000(IEC)	360	39.5	9.12	47.2	9.64	
TP672P-355	1000(IEC)	355	39.2	9.07	47	9.58	
TP672P-350	1000(IEC)	350	38.9	9.01	46.8	9.52	
TP672P-345	1000(IEC)	345	38.6	8.95	46.6	9.46	
TP672P-340	1000(IEC)	340	38.3	8.89	46.4	9.4	
TP672P-335	1000(IEC)	335	38	8.82	46.2	9.34	
TP672P-330	1000(IEC)	330	37.7	8.76	45.9	9.27	
TP672P-325	1000(IEC)	325	37.4	8.7	45.7	9.22	
TP672P-320	1000(IEC)	320	37.1	8.63	45.5	9.16	
TP672P-315	1000(IEC)	315	36.8	8.56	45.2	9.11	
TP672P-310	1000(IEC)	310	36.5	8.5	45	9.06	
TP672P-305	1000(IEC)	305	36.3	8.41	44.8	9.01	
TP672P-300	1000(IEC)	300	36	8.34	44.5	8.95	

Suzhou Talesun Solar Technologies Co., Ltd

Address: No. 1 Talesun Road, Changkun Industrial Park, Shajiang Town, Changshu, Suzhou, Jiangsu Province, 215542, P.R.China

Website: www.talesun.com Email: sales@talesun.com Tel: +86 400 885 1098



TITLE:
Installation manual for crystalline solar
photovoltaic modules (IEC)

SPEC.NO TS-ET-052

REV A2

Effective Date 07-2020

Page 19 of 29

Module	Maximum System Voltage(V)	Pmax (W)	Vmpp (V)	Imp (A)	Voc (V)	Isc (A)	Fuse Rating (A)
TP672M-415	1000(IEC)	415	41.6	9.99	50.2	10.46	20
TP672M-410	1000(IEC)	410	41.4	9.92	50.0	10.40	
TP672M-405	1000(IEC)	405	41.1	9.86	49.8	10.34	
TP672M-400	1000(IEC)	400	40.9	9.78	49.5	10.26	
TP672M-395	1000(IEC)	395	40.7	9.71	49.3	10.18	
TP672M-390	1000(IEC)	390	40.5	9.64	49.2	10.11	
TP672M-385	1000(IEC)	385	40.3	9.57	49.0	10.04	
TP672M-380	1000(IEC)	380	40.0	9.5	48.7	9.97	
TP672M-375	1000(IEC)	375	39.8	9.43	48.5	9.89	
TP672M-370	1000(IEC)	370	39.6	9.35	48.3	9.83	
TP672M-365	1000(IEC)	365	39.3	9.29	48.0	9.77	
TP672M-360	1000(IEC)	360	39.1	9.21	47.8	9.7	
TP672M-355	1000(IEC)	355	38.9	9.13	47.6	9.63	
TP672M-350	1000(IEC)	350	38.7	9.04	47.3	9.58	
TP672M-345	1000(IEC)	345	38.5	8.96	47.0	9.54	
TP672M-340	1000(IEC)	340	38.2	8.9	46.8	9.45	
TP672M-335	1000(IEC)	335	38.0	8.82	46.6	9.36	
TP672M-330	1000(IEC)	330	37.8	8.73	46.3	9.29	
TP672M-325	1000(IEC)	325	37.6	8.64	46.1	9.2	
TP660P-320	1000(IEC)	320	34.4	9.32	41.4	9.79	20
TP660P-315	1000(IEC)	315	34.1	9.25	41.1	9.72	
TP660P-310	1000(IEC)	310	33.8	9.18	40.8	9.65	
TP660P-305	1000(IEC)	305	33.5	9.11	40.5	9.58	
TP660P-300	1000(IEC)	300	33.2	9.04	40.2	9.51	
TP660P-295	1000(IEC)	295	32.9	8.97	39.9	9.44	
TP660P-290	1000(IEC)	290	32.6	8.90	39.6	9.37	
TP660P-285	1000(IEC)	285	32.3	8.83	39.3	9.30	
TP660P-280	1000(IEC)	280	32.0	8.76	39.0	9.25	

Suzhou Talesun Solar Technologies Co., Ltd

Address: No. 1 Talesun Road, Changkun Industrial Park, Shajiang Town, Changshu, Suzhou, Jiangsu Province, 215542, P.R.China

Website: www.talesun.com Email: sales@talesun.com Tel: +86 400 885 1098



TITLE:
Installation manual for crystalline solar
photovoltaic modules (IEC)

SPEC.NO TS-ET-052

REV A2

Effective Date 07-2020

Page 20 of 29

Module	Maximum System Voltage(V)	Pmax (W)	Vmpp (V)	Imp (A)	Voc (V)	Isc (A)	Fuse Rating (A)
TP660P-275	1000(IEC)	275	31.7	8.69	38.7	9.17	20
TP660P-270	1000(IEC)	270	31.3	8.63	38.5	9.09	
TP660P-265	1000(IEC)	265	31.0	8.56	38.2	9.04	
TP660P-260	1000(IEC)	260	30.6	8.50	37.9	8.97	
TP660P-255	1000(IEC)	255	30.2	8.45	37.5	8.94	
TP660M-345	1000(IEC)	345	36.3	9.51	41.5	10.12	20
TP660M-340	1000(IEC)	340	36.0	9.46	41.3	10.05	
TP660M-335	1000(IEC)	335	35.6	9.43	41.1	9.99	
TP660M-330	1000(IEC)	330	35.2	9.40	40.9	9.94	
TP660M-325	1000(IEC)	325	34.7	9.37	40.7	9.87	
TP660M-320	1000(IEC)	320	34.3	9.34	40.5	9.81	
TP660M-315	1000(IEC)	315	33.9	9.30	40.3	9.75	
TP660M-310	1000(IEC)	310	33.5	9.26	40.1	9.69	
TP660M-305	1000(IEC)	305	33.2	9.20	39.9	9.64	
TP660M-300	1000(IEC)	300	32.9	9.12	39.7	9.58	
TP660M-295	1000(IEC)	295	32.6	9.05	39.5	9.52	
TP660M-290	1000(IEC)	290	32.4	8.96	39.3	9.47	
TP660M-285	1000(IEC)	285	32.1	8.88	39.1	9.41	
TP660M-280	1000(IEC)	280	31.8	8.81	38.9	9.35	
TP660M-275	1000(IEC)	275	31.5	8.73	38.7	9.30	
TP660M-270	1000(IEC)	270	31.3	8.64	38.5	9.24	

Module	Maximum System Voltage(V)	Pmax (W)	Vmpp (V)	Imp (A)	Voc (V)	Isc (A)	Fuse Rating (A)
TP672P-385	1500(IEC)	385	41	9.42	48.2	9.95	20
TP672P-380	1500(IEC)	380	40.7	9.36	48	9.89	
TP672P-375	1500(IEC)	375	40.4	9.3	47.8	9.83	
TP672P-370	1500(IEC)	370	40.1	9.24	47.6	9.77	

Suzhou Talesun Solar Technologies Co., Ltd

Address: No. 1 Talesun Road, Changkun Industrial Park, Shajiang Town, Changshu, Suzhou, Jiangsu Province, 215542, P.R.China

Website: www.talesun.com Email: sales@talesun.com Tel: +86 400 885 1098



TITLE:
Installation manual for crystalline solar photovoltaic modules (IEC)

SPEC.NO	TS-ET-052
REV	A2
Effective Date	07-2020

Page 21 of 29

Module	Maximum System Voltage(V)	Pmax (W)	Vmpp (V)	Imp (A)	Voc (V)	Isc (A)	Fuse Rating (A)
TP672P-365	1500(IEC)	365	39.8	9.18	47.4	9.71	20
TP672P-360	1500(IEC)	360	39.5	9.12	47.2	9.64	
TP672P-355	1500(IEC)	355	39.2	9.07	47	9.58	
TP672P-350	1500(IEC)	350	38.9	9.01	46.8	9.52	
TP672P-345	1500(IEC)	345	38.6	8.95	46.6	9.46	
TP672P-340	1500(IEC)	340	38.3	8.89	46.4	9.4	
TP672P-335	1500(IEC)	335	38	8.82	46.2	9.34	
TP672P-330	1500(IEC)	330	37.7	8.76	45.9	9.27	
TP672P-325	1500(IEC)	325	37.4	8.7	45.7	9.22	
TP672P-320	1500(IEC)	320	37.1	8.63	45.5	9.16	
TP672P-315	1500(IEC)	315	36.8	8.56	45.2	9.11	
TP672P-310	1500(IEC)	310	36.5	8.5	45	9.06	
TP672P-305	1500(IEC)	305	36.3	8.41	44.8	9.01	
TP672P-300	1500(IEC)	300	36	8.34	44.5	8.95	
TP672M-415	1500(IEC)	415	41.6	9.99	50.2	10.46	20
TP672M-410	1500(IEC)	410	41.4	9.92	50.0	10.40	
TP672M-405	1500(IEC)	405	41.1	9.86	49.8	10.34	
TP672M-400	1500(IEC)	400	40.9	9.78	49.5	10.26	
TP672M-395	1500(IEC)	395	40.7	9.71	49.3	10.18	
TP672M-390	1500(IEC)	390	40.5	9.64	49.2	10.11	
TP672M-385	1500(IEC)	385	40.3	9.57	49.0	10.04	
TP672M-380	1500(IEC)	380	40.0	9.5	48.7	9.97	
TP672M-375	1500(IEC)	375	39.8	9.43	48.5	9.89	
TP672M-370	1500(IEC)	370	39.6	9.35	48.3	9.83	
TP672M-365	1500(IEC)	365	39.3	9.29	48.0	9.77	
TP672M-360	1500(IEC)	360	39.1	9.21	47.8	9.7	
TP672M-355	1500(IEC)	355	38.9	9.13	47.6	9.63	
TP672M-350	1500(IEC)	350	38.7	9.04	47.3	9.58	

Suzhou Talesun Solar Technologies Co., Ltd

Address: No. 1 Talesun Road, Changkun Industrial Park, Shajiang Town, Changshu, Suzhou, Jiangsu Province, 215542, P.R.China

Website: www.talesun.com Email: sales@talesun.com Tel: +86 400 885 1098



TITLE:
Installation manual for crystalline solar
photovoltaic modules (IEC)

SPEC.NO TS-ET-052

REV A2

Effective Date 07-2020

Page 22 of 29

Module	Maximum System Voltage(V)	Pmax (W)	Vmpp (V)	Imp (A)	Voc (V)	Isc (A)	Fuse Rating (A)
TP672M-345	1500(IEC)	345	38.5	8.96	47.0	9.54	20
TP672M-340	1500(IEC)	340	38.2	8.9	46.8	9.45	
TP672M-335	1500(IEC)	335	38.0	8.82	46.6	9.36	
TP672M-330	1500(IEC)	330	37.8	8.73	46.3	9.29	
TP672M-325	1500(IEC)	325	37.6	8.64	46.1	9.2	
TP660P-320	1500(IEC)	320	34.4	9.32	41.4	9.79	20
TP660P-315	1500(IEC)	315	34.1	9.25	41.1	9.72	
TP660P-310	1500(IEC)	310	33.8	9.18	40.8	9.65	
TP660P-305	1500(IEC)	305	33.5	9.11	40.5	9.58	
TP660P-300	1500(IEC)	300	33.2	9.04	40.2	9.51	
TP660P-295	1500(IEC)	295	32.9	8.97	39.9	9.44	
TP660P-290	1500(IEC)	290	32.6	8.90	39.6	9.37	
TP660P-285	1500(IEC)	285	32.3	8.83	39.3	9.30	
TP660P-280	1500(IEC)	280	32.0	8.76	39.0	9.25	
TP660P-275	1500(IEC)	275	31.7	8.69	38.7	9.17	
TP660P-270	1500(IEC)	270	31.3	8.63	38.5	9.09	
TP660P-265	1500(IEC)	265	31.0	8.56	38.2	9.04	
TP660P-260	1500(IEC)	260	30.6	8.50	37.9	8.97	
TP660P-255	1500(IEC)	255	30.2	8.45	37.5	8.94	
TP660M-345	1500(IEC)	345	36.3	9.51	41.5	10.12	20
TP660M-340	1500(IEC)	340	36.0	9.46	41.3	10.05	
TP660M-335	1500(IEC)	335	35.6	9.43	41.1	9.99	
TP660M-330	1500(IEC)	330	35.2	9.40	40.9	9.94	
TP660M-325	1500(IEC)	325	34.7	9.37	40.7	9.87	
TP660M-320	1500(IEC)	320	34.3	9.34	40.5	9.81	
TP660M-315	1500(IEC)	315	33.9	9.30	40.3	9.75	
TP660M-310	1500(IEC)	310	33.5	9.26	40.1	9.69	

Suzhou Talesun Solar Technologies Co., Ltd

Address: No. 1 Talesun Road, Changkun Industrial Park, Shajiang Town, Changshu, Suzhou, Jiangsu Province, 215542, P.R.China

Website: www.talesun.com Email: sales@talesun.com Tel: +86 400 885 1098

 Suzhou Talesun Solar Technologies Co., Ltd.	Technical specifications	
	TITLE: Installation manual for crystalline solar photovoltaic modules (IEC)	SPEC.NO
	REV	A2
	Effective Date	07-2020
		Page 23 of 29

Module	Maximum System Voltage(V)	Pmax (W)	Vmpp (V)	Impp (A)	Voc (V)	Isc (A)	Fuse Rating (A)
TP660M-305	1500(IEC)	305	33.2	9.20	39.9	9.64	20
TP660M-300	1500(IEC)	300	32.9	9.12	39.7	9.58	
TP660M-295	1500(IEC)	295	32.6	9.05	39.5	9.52	
TP660M-290	1500(IEC)	290	32.4	8.96	39.3	9.47	
TP660M-285	1500(IEC)	285	32.1	8.88	39.1	9.41	
TP660M-280	1500(IEC)	280	31.8	8.81	38.9	9.35	
TP660M-275	1500(IEC)	275	31.5	8.73	38.7	9.30	
TP660M-270	1500(IEC)	270	31.3	8.64	38.5	9.24	

7 Newly added 158.75 large cell technical data

Type	TP672P-***	TP672M-***	TP660P-***	TP660M-***	TP678M-***
Type	TP672P (H) -***	TP672M (H) -***	TP660P (H) -***	TP660M (H) -***	TP678M (H) -***
Power	***=315-360 in 5W steps	***=325-400 in 5W steps	***=270-300 in 5W steps	***=270-335 in 5W steps	***=400-455 in 5W steps
Type	6 inch *6 inch /72cells/ Poly-	6 inch *6 inch /72cells/ Mono-	6 inch *6 inch /60cells/ Poly-	6 inch *6 inch /60cells/ Mono-	6 inch *6 inch /78cells/ Mono-
Dimension [mm]	1979*1002*35	1979*1002*35	1665*1002*35	1665*1002*35	2140*1002*35
Weight [kg]	22.5	22.5	19	19	24.5

Max. system voltage [V]	1500/1000
Junction box	Protection class IP 67 with bypass diode
Connector	MC3 or MC4 or MC3 compatible type or MC4 compatible type

Suzhou Talesun Solar Technologies Co., Ltd

Address: No. 1 Talesun Road, Changkun Industrial Park, Shajiang Town, Changshu, Suzhou, Jiangsu Province, 215542, P.R.China

Website: www.talesun.com Email: sales@talesun.com Tel: +86 400 885 1098
23 / 29



TITLE: Installation manual for crystalline solar photovoltaic modules (IEC)	SPEC.NO	TS-ET-052
	REV	A2
	Effective Date	07-2020
		Page 24 of 29

Flammability rating	C
Application class	A
Static load [Pa]	5400

Module	Maximum System Voltage(V)	Pmax (W)	Vmpp (V)	Impp (A)	Voc (V)	Isc (A)	Fuse Rating (A)
TP672P-360	1000(IEC)	360	38.9	9.26	47.1	9.76	20
TP672P-355	1000(IEC)	355	38.6	9.20	46.8	9.70	
TP672P-350	1000(IEC)	350	38.3	9.14	46.5	9.64	
TP672P-345	1000(IEC)	345	38.0	9.08	46.2	9.58	
TP672P-340	1000(IEC)	340	37.7	9.02	46.0	9.51	
TP672P-335	1000(IEC)	335	37.4	8.96	45.7	9.46	
TP672P-330	1000(IEC)	330	37.1	8.89	45.5	9.40	
TP672P-325	1000(IEC)	325	36.9	8.82	45.3	9.33	
TP672P-320	1000(IEC)	320	36.6	8.74	45.0	9.26	
TP672P-315	1000(IEC)	315	36.4	8.66	44.8	9.20	
TP672M-400	1000(IEC)	400	40.5	9.88	49.2	10.48	20
TP672M-395	1000(IEC)	395	40.3	9.81	49.0	10.41	
TP672M-390	1000(IEC)	390	40.0	9.75	48.7	10.35	
TP672M-385	1000(IEC)	385	39.8	9.68	48.5	10.28	
TP672M-380	1000(IEC)	380	39.6	9.60	48.3	10.20	
TP672M-375	1000(IEC)	375	39.3	9.55	48.0	10.15	
TP672M-370	1000(IEC)	370	39.1	9.47	47.8	10.07	
TP672M-365	1000(IEC)	365	38.9	9.39	47.6	9.99	
TP672M-360	1000(IEC)	360	38.7	9.31	47.3	9.91	
TP672M-355	1000(IEC)	355	38.5	9.23	47.0	9.83	
TP672M-350	1000(IEC)	350	38.2	9.17	46.8	9.77	
TP672M-345	1000(IEC)	345	38.0	9.09	46.6	9.69	
TP672M-340	1000(IEC)	340	37.8	9.01	46.3	9.61	

Suzhou Talesun Solar Technologies Co., Ltd

Address: No. 1 Talesun Road, Changkun Industrial Park, Shajiang Town, Changshu, Suzhou, Jiangsu Province, 215542, P.R.China

Website: www.talesun.com Email: sales@talesun.com Tel: +86 400 885 1098



TITLE:
Installation manual for crystalline solar
photovoltaic modules (IEC)

SPEC.NO	TS-ET-052
REV	A2
Effective Date	07-2020

TP672M-335	1000(IEC)	335	37.6	8.91	46.1	9.51	
TP672M-330	1000(IEC)	330	37.4	8.83	45.8	9.43	
TP672M-325	1000(IEC)	325	37.2	8.74	45.6	9.34	
20							
TP660P-300	1000(IEC)	300	32.6	9.21	39.6	9.89	
TP660P-295	1000(IEC)	295	32.3	9.14	39.3	9.81	
TP660P-290	1000(IEC)	290	32.0	9.07	39.0	9.73	
TP660P-285	1000(IEC)	285	31.7	9.00	38.7	9.65	
TP660P-280	1000(IEC)	280	31.3	8.95	38.5	9.57	
TP660P-275	1000(IEC)	275	31.0	8.88	38.2	9.49	
TP660P-270	1000(IEC)	270	30.6	8.83	37.9	9.41	
20							
TP660M-335	1000(IEC)	335	34.7	9.69	40.7	10.29	
TP660M-330	1000(IEC)	330	34.3	9.66	40.5	10.26	
TP660M-325	1000(IEC)	325	33.9	9.62	40.3	10.22	
TP660M-320	1000(IEC)	320	33.5	9.56	40.1	10.16	
TP660M-315	1000(IEC)	315	33.2	9.49	39.9	10.09	
TP660M-310	1000(IEC)	310	32.9	9.43	39.7	10.03	
TP660M-305	1000(IEC)	305	32.6	9.36	39.5	9.96	
TP660M-300	1000(IEC)	300	32.4	9.30	39.3	9.90	
TP660M-295	1000(IEC)	295	32.1	9.24	39.1	9.85	
TP660M-290	1000(IEC)	290	31.8	9.15	38.9	9.75	
TP660M-285	1000(IEC)	285	31.5	9.05	38.7	9.65	
TP660M-280	1000(IEC)	280	31.3	8.95	38.5	9.55	
TP660M-275	1000(IEC)	275	31.0	8.87	38.3	9.45	
TP660M-270	1000(IEC)	270	30.7	8.78	38.0	9.34	
20							
TP678M-455	1000(IEC)	455	44.5	10.23	54.0	10.78	
TP678M-450	1000(IEC)	450	44.3	10.16	53.8	10.71	
TP678M-445	1000(IEC)	445	44.1	10.10	53.6	10.65	
TP678M-440	1000(IEC)	440	43.9	10.03	53.4	10.58	

Suzhou Talesun Solar Technologies Co., Ltd

Address: No. 1 Talesun Road, Changkun Industrial Park, Shajiang Town, Changshu, Suzhou, Jiangsu Province, 215542, P.R.China

Website: www.talesun.com Email: sales@talesun.com Tel: +86 400 885 1098



TITLE:
Installation manual for crystalline solar photovoltaic modules (IEC)

SPEC.NO	TS-ET-052
REV	A2
Effective Date	07-2020

TP678M-435	1000(IEC)	435	43.7	9.96	53.2	10.51
TP678M-430	1000(IEC)	430	43.5	9.89	53.0	10.45
TP678M-425	1000(IEC)	425	43.3	9.82	52.8	10.38
TP678M-420	1000(IEC)	420	43.1	9.75	52.6	10.31
TP678M-415	1000(IEC)	415	42.9	9.68	52.4	10.24
TP678M-410	1000(IEC)	410	42.7	9.61	52.2	10.17
TP678M-405	1000(IEC)	405	42.5	9.54	52.0	10.10
TP678M-400	1000(IEC)	400	42.3	9.47	51.8	10.03

Module	Maximum System Voltage(V)	Pmax (W)	Vmpp (V)	Imp (A)	Voc (V)	Isc (A)	Fuse Rating (A)
TP672P(H)-360	1500(IEC)	360	38.9	9.26	47.1	10.12	20
TP672P(H)-355	1500(IEC)	355	38.6	9.20	46.8	10.06	
TP672P(H)-350	1500(IEC)	350	38.3	9.14	46.5	10.00	
TP672P(H)-345	1500(IEC)	345	38.0	9.08	46.2	9.94	
TP672P(H)-340	1500(IEC)	340	37.7	9.02	46.0	9.88	
TP672P(H)-335	1500(IEC)	335	37.4	8.96	45.7	9.82	
TP672P(H)-330	1500(IEC)	330	37.1	8.89	45.5	9.76	
TP672P(H)-325	1500(IEC)	325	36.9	8.82	45.3	9.70	
TP672P(H)-320	1500(IEC)	320	36.6	8.74	45.0	9.64	
TP672P(H)-315	1500(IEC)	315	36.4	8.66	44.8	9.58	
TP672M(H)-400	1500(IEC)	400	40.5	9.88	49.2	10.48	20
TP672M(H)-395	1500(IEC)	395	40.3	9.81	49.0	10.41	
TP672M(H)-390	1500(IEC)	390	40.0	9.75	48.7	10.35	
TP672M(H)-385	1500(IEC)	385	39.8	9.68	48.5	10.28	
TP672M(H)-380	1500(IEC)	380	39.6	9.60	48.3	10.20	
TP672M(H)-375	1500(IEC)	375	39.3	9.55	48.0	10.15	
TP672M(H)-370	1500(IEC)	370	39.1	9.47	47.8	10.07	
TP672M(H)-365	1500(IEC)	365	38.9	9.39	47.6	9.99	
TP672M(H)-360	1500(IEC)	360	38.7	9.31	47.3	9.91	

Suzhou Talesun Solar Technologies Co., Ltd

Address: No. 1 Talesun Road, Changkun Industrial Park, Shajiang Town, Changshu, Suzhou, Jiangsu Province, 215542, P.R.China



TITLE:
Installation manual for crystalline solar photovoltaic modules (IEC)

SPEC.NO	TS-ET-052
REV	A2
Effective Date	07-2020

Page 27 of 29

TP672M(H)-355	1500(IEC)	355	38.5	9.23	47.0	9.83	
TP672M(H)-350	1500(IEC)	350	38.2	9.17	46.8	9.77	
TP672M(H)-345	1500(IEC)	345	38.0	9.09	46.6	9.69	
TP672M(H)-340	1500(IEC)	340	37.8	9.01	46.3	9.61	
TP672M(H)-335	1500(IEC)	335	37.6	8.91	46.1	9.51	
TP672M(H)-330	1500(IEC)	330	37.4	8.83	45.8	9.43	
TP672M(H)-325	1500(IEC)	325	37.2	8.74	45.6	9.34	
TP660P(H)-300	1500(IEC)	300	32.6	9.21	39.6	9.89	20
TP660P(H)-295	1500(IEC)	295	32.3	9.14	39.3	9.81	
TP660P(H)-290	1500(IEC)	290	32.0	9.07	39.0	9.73	
TP660P(H)-285	1500(IEC)	285	31.7	9.00	38.7	9.65	
TP660P(H)-280	1500(IEC)	280	31.3	8.95	38.5	9.57	
TP660P(H)-275	1500(IEC)	275	31.0	8.88	38.2	9.49	
TP660P(H)-270	1500(IEC)	270	30.6	8.83	37.9	9.41	
TP660M(H)-335	1500(IEC)	335	34.7	9.69	40.7	10.29	20
TP660M(H)-330	1500(IEC)	330	34.3	9.66	40.5	10.26	
TP660M(H)-325	1500(IEC)	325	33.9	9.62	40.3	10.22	
TP660M(H)-320	1500(IEC)	320	33.5	9.56	40.1	10.16	
TP660M(H)-315	1500(IEC)	315	33.2	9.49	39.9	10.09	
TP660M(H)-310	1500(IEC)	310	32.9	9.43	39.7	10.03	
TP660M(H)-305	1500(IEC)	305	32.6	9.36	39.5	9.96	
TP660M(H)-300	1500(IEC)	300	32.4	9.30	39.3	9.90	
TP660M(H)-295	1500(IEC)	295	32.1	9.24	39.1	9.85	
TP660M(H)-290	1500(IEC)	290	31.8	9.15	38.9	9.75	
TP660M(H)-285	1500(IEC)	285	31.5	9.05	38.7	9.65	
TP660M(H)-280	1500(IEC)	280	31.3	8.95	38.5	9.55	
TP660M(H)-275	1500(IEC)	275	31.0	8.87	38.3	9.45	
TP660M(H)-270	1500(IEC)	270	30.7	8.78	38.0	9.34	

Suzhou Talesun Solar Technologies Co., Ltd

Address: No. 1 Talesun Road, Changkun Industrial Park, Shajiang Town, Changshu, Suzhou, Jiangsu Province, 215542, P.R.China

Website: www.talesun.com Email: sales@talesun.com Tel: +86 400 885 1098

 Suzhou Talesun Solar Technologies Co., Ltd.	Technical specifications	
	TITLE: Installation manual for crystalline solar photovoltaic modules (IEC)	SPEC.NO REV Effective Date
		Page 28 of 29

TP678M(H)-455	1500(IEC)	455	44.5	10.23	54.0	10.78	20
TP678M(H)-450	1500(IEC)	450	44.3	10.16	53.8	10.71	
TP678M(H)-445	1500(IEC)	445	44.1	10.10	53.6	10.65	
TP678M(H)-440	1500(IEC)	440	43.9	10.03	53.4	10.58	
TP678M(H)-435	1500(IEC)	435	43.7	9.96	53.2	10.51	
TP678M(H)-430	1500(IEC)	430	43.5	9.89	53.0	10.45	
TP678M(H)-425	1500(IEC)	425	43.3	9.82	52.8	10.38	
TP678M(H)-420	1500(IEC)	420	43.1	9.75	52.6	10.31	
TP678M(H)-415	1500(IEC)	415	42.9	9.68	52.4	10.24	
TP678M(H)-410	1500(IEC)	410	42.7	9.61	52.2	10.17	
TP678M(H)-405	1500(IEC)	405	42.5	9.54	52.0	10.10	
TP678M(H)-400	1500(IEC)	400	42.3	9.47	51.8	10.03	

CHINA

1# Talesun Road, Shajiabang, Changshu, Jiangsu Province, P.R. China 215542

Email: sales@talesun.com/marketing@talesun.com

Web: www.talesun.com

Sales Hotline: +86 400 885 1098

TEL: +86 512 8235 5888

FAX: +86 512 8235 5588

JAPAN

6F, 3-22-1, Toranomom, Minato-ku, Tokyo, Japan (105-0001)

Email: japan@talesun.com

Web: www.talesun.com/?jp

T: +03 5733 3498

F: +03 34341515

USA

25 METRO DRIVE, Suite 228, San Jose, CA, 95 110 USA..

Email: sales@talesun.com

Suzhou Talesun Solar Technologies Co., Ltd

Address: No. 1 Talesun Road, Changkun Industrial Park, Shajiabang Town, Changshu, Suzhou, Jiangsu Province, 215542, P.R.China

Website: www.talesun.com

Email: sales@talesun.com

Tel: +86 400 885 1098

 Suzhou Talesun Solar Technologies Co., Ltd.	Technical specifications	
TITLE: Installation manual for crystalline solar photovoltaic modules (IEC)	SPEC.NO	TS-ET-052
	REV	A2
	Effective Date	07-2020
		Page 29 of 29

Tel: (408) 638-7627

Fax: (408) 642-1279

UK

Talesun Energy UK Ltd. 42, Upper Berkeley Street, London, W1H5PW United Kingdom

Email: projects@talesunenergy.com

Web: www.taesun-eu.com

Tel: +44 (0)20 3752 6516

GERMANY

Central Tower Munich, Landsberger Strasse 110, 80339 Munich, Germany

Email: info@talesunenergy.com

Web: www.taesun-eu.com

T: +49(0)89- 189 177-0

F: +49(0)89-189-177-499

THAILAND

Thai-China Industrial Park in Rayong,

Email: Marketing.hq@talesun.com

TEL: +86 512 8235 5258

France

2405,Route des Dolines-06560 SophiaAntipolis-France

Email: Sales@talesun.com

TEL: +33 489 82 92 78

Suzhou Talesun Solar Technologies Co., Ltd

Address: No. 1 Talesun Road, Changkun Industrial Park, Shajiang Town, Changshu, Suzhou, Jiangsu Province, 215542, P.R.China

Website: www.taesun.com

Email: sales@talesun.com

Tel: +86 400 885 1098