



FLEXmax Series Charge Controllers

(FLEXmax 80, FLEXmax 60)

Owner's Manual



About OutBack Power Technologies

OutBack Power Technologies is a leader in advanced energy conversion technology. Our products include true sine wave inverter/chargers, maximum power point tracking charge controllers, and system communication components, as well as circuit breakers, batteries, accessories, and assembled systems.

Contact Information

Address:	Corporate Headquarters 17825 – 59 th Avenue N.E. Suite B Arlington, WA 98223 USA	European Office Hansastraße 8 D-91126 Schwabach, Germany
Telephone:	+1.360.435.6030 +1.360.618.4363 (Technical Support) +1.360.435.6019 (Fax)	+49.9122.79889.0 +49.9122.79889.21 (Fax)
Email:	Support@outbackpower.com	
Website:	http://www.outbackpower.com	

Disclaimer

UNLESS SPECIFICALLY AGREED TO IN WRITING, OUTBACK POWER TECHNOLOGIES:

(a) MAKES NO WARRANTY AS TO THE ACCURACY, SUFFICIENCY OR SUITABILITY OF ANY TECHNICAL OR OTHER INFORMATION PROVIDED IN ITS MANUALS OR OTHER DOCUMENTATION.

(b) ASSUMES NO RESPONSIBILITY OR LIABILITY FOR LOSS OR DAMAGE, WHETHER DIRECT, INDIRECT, CONSEQUENTIAL OR INCIDENTAL, WHICH MIGHT ARISE OUT OF THE USE OF SUCH INFORMATION. THE USE OF ANY SUCH INFORMATION WILL BE ENTIRELY AT THE USER'S RISK.

Notice of Copyright

FLEXmax Series Charge Controllers Owner's Manual © July 2013 by OutBack Power Technologies. All Rights Reserved.

Trademarks

OutBack Power and the OutBack Power logo are trademarks owned and used by OutBack Power Technologies, Inc. The ALPHA logo and the phrase "member of the Alpha Group" are trademarks owned and used by Alpha Technologies Inc. These trademarks may be registered in the United States and other countries.

Date and Revision

July 2013, Revision C

Part Number

900-0009-01-00 Rev C



Table of Contents

Introduction.....	5
Features	5
Firmware.....	5
Soft Keys	6
Installation.....	7
Standards and Requirements.....	7
Grounding	7
DC and Battery-Related Installation Requirements.....	7
Dimensions.....	8
Mounting the Charge Controller.....	9
Wiring	10
Wire and Disconnect Sizing.....	10
FLEXmax 80	10
FLEXmax 60	10
Wiring Compartment.....	11
Operation.....	15
Power Up Screens.....	15
Version and/or Voltage Setting Screens.....	16
Status Screen	17
End-of-Day Summary Screen.....	18
Navigating the End-of-Day Screens and Data Logging	19
Modes of Operation.....	20
Absorbing.....	20
Auto Start (Auto ReStart).....	21
BatTmpErr.....	21
BatTooHot	21
Charged.....	21
EQ	21
EQ Done	21
EX-Absorb.....	22
Floating	22
GT Mode.....	22
High Voc.....	22
Low Light or Snoozing	22
MPPT Bulk.....	22
MPPT Float.....	22
MPPT EQ.....	23
New Voc	23
OvrCurrent.....	23
Over Temp.....	23
Re-Cal	23
Sleeping	23
Sys Error.....	23
Tracking.....	23
Unloaded	24
Wakeup.....	24
Zzzzz.....	24
Initial Operation	24

Table of Contents

Changing the Settings on the FLEXmax	24
Accessing the Main Menu	24
Main Menu Map.....	25
Charger Screen.....	26
Aux Screens.....	27
AUX MODE Screen Navigation.....	29
Vent Fan (AUX Mode).....	30
PV Trigger (AUX Mode).....	31
Error Output (AUX Mode)	32
Night Light (AUX Mode).....	33
Float (AUX Mode)	34
Diversion (AUX Mode).....	35
Low Battery Disconnect (AUX Mode).....	40
Remote (AUX Mode).....	41
Backlight.....	41
EQ – Battery Equalize	42
Misc Screen.....	44
Advanced Menu.....	46
Snooze Mode (Advanced Menu)	46
Wakeup Mode (Advanced Menu)	47
MPPT Mode (Advanced Menu)	47
Absorb Time Limits (Advanced Menu).....	49
Absorb End Amps (Advanced Menu).....	49
Rebulk Voltage (Advanced Menu).....	50
Vbatt Calibration (Advanced Menu).....	50
RTS Compensation (Advanced Menu).....	50
Auto ReStart (Advanced Menu)	52
Aux Polarity (Advanced Menu)	53
Reset to Defaults?	53
Logging	54
Stats	55
Viewing the Firmware Revision.....	56
Extended Play Mode	56
Rebooting the FLEXmax	57
MATE3 System Display and Controller	59
Display and LED Status Indicators.....	59
Charge Controller Soft Key.....	60
DataLog Screen	61
Graph Screens.....	62
Menu Structure in the MATE3	63
Charge Controller Settings.....	64
Charger.....	64
MPPT.....	64
Temperature Compensation.....	65
Battery Equalize	65
Grid-Tie Mode.....	65
Auxiliary Output (Charge Controller)	66
Aux Modes for the Charge Controller	66
Restart Mode.....	67
Calibrate	68
Reset Charge Controller to Factory Defaults.....	68
Device Data Logs	69
Saving Data Logs for the FLEXmax Charge Controller	69
Data Log File Format	70
MATE/MATE2 Screens.....	71

Summary Screens	71
Status Screens	72
MODE Screens	72
METER Screens	73
SETPT Screens	74
LOG Screens	75
STAT Screens	76
Advanced Menus	77
Accessing the Advanced Menus	77
CHGR Menu	78
CC ADVANCED Menu	79
EQ Menu	80
AUX Menu	81
MATE and MATE2 Menu Maps for the FLEXmax	82
STATUS Menu Map	82
Advanced Menu Map	84
Menu Maps for the FLEXmax	87
Troubleshooting	91
Specifications	93
Electrical and Mechanical Specifications	93
Firmware Revision	93
Regulatory Specifications	93
Default Settings and Ranges	94
Applications	95
Maximum Power Point Tracking	95
Three-Stage Battery Charging	96
BULK	96
ABSORBING	97
FLOAT	97
Battery Temperature Compensation	97
Array Design	98
Sizing Guidelines	98
Open Circuit Voltage (Voc)	98
Weather Conditions	98
Maximum-Power Voltage (Vmp)	99
Standard vs. Australian Default Settings	99
Hydroelectric and Fuel Cell Applications Performance Optimization	100
Auto Track Mode	100
U-Pick Mode	100
Grid-Interactive Settings	102
Charge Controller Efficiency vs. Input Power	102
Definitions	103
Index	105

List of Tables

Table 1	Battery Voltage and Charge Timer.....	21
Table 2	Aux Mode Functions.....	27
Table 3	Regulatory Specifications for All Models.....	93
Table 4	FLEXmax Settings.....	94
Table 5	Maximum PV Input Wattage per Charge Controller.....	98
Table 6	Default Settings Standard vs. Australian.....	99
Table 7	Terms and Definitions.....	103



Introduction



IMPORTANT:

This manual provides safety guidelines and installation information for the FLEXmax Series Charge Controllers. It does not provide information about specific brands of PV modules and supplies limited information on batteries.

Contact the supplier or manufacturer of the PV modules or batteries for additional information.

Thank you for purchasing a FLEXmax Series Charge Controller (CC). These charge controllers offer an efficient, safe, multi-stage recharging process that prolongs battery life and assures peak performance from a PV array.

Each charge controller is designed to seamlessly integrate with other OutBack components and can be remotely monitored and configured (up to 1000 feet or 300 meters away) using the optional OutBack Power Technologies system displays.

Features

The FLEXmax Charge Controllers use continuous Maximum Power Point Tracking (MPPT), which seeks out the maximum power available from a PV array and uses it to recharge the batteries. Without this feature, the PV array does not operate at the ideal voltage and can only operate at the level of the battery voltage itself. (See page 95 for a description of MPPT.) Each charge controller continuously tracks the array's maximum operating power.

The FLEXmax Series has two models available:

- **FLEXmax 80:** 80 amps maximum continuous output current (up to 40°C without thermal derating)
- **FLEXmax 60:** 60 amps maximum continuous output current (up to 40°C without thermal derating)

Both models have the following features:

- Supports 12, 24, 36, 48, and 60 Vdc battery voltages
- Backlit LCD display screen with 80 characters (4 lines, 20 characters per line)
- Last 128 days of operational data are logged for review
- Voltage step-down capability allowing a higher PV array voltage configuration
- Manual and auto-equalize cycle

Firmware

This manual covers FLEXmax firmware revision 002.001.xxx.

Introduction

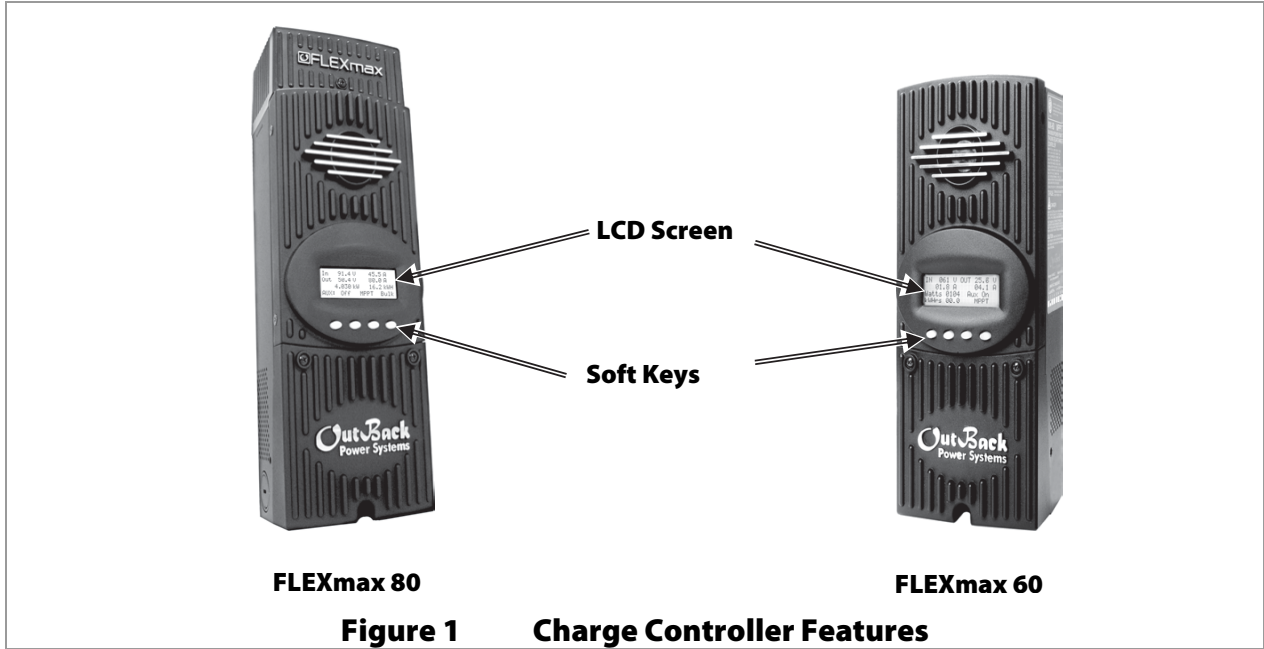

Soft Keys

Four “soft” keys are located directly below the LCD. The functions of the soft keys will vary depending on the location of the user within the menu structure. Some soft keys will be used for navigation. Some soft keys will be used for programming.

Soft key functions are identified by text in the LCD screen directly above the key (e.g., **EXIT**). In this manual, soft keys will be identified by brackets (for example, **<EXIT>**). Not every soft key may be used in some screens.

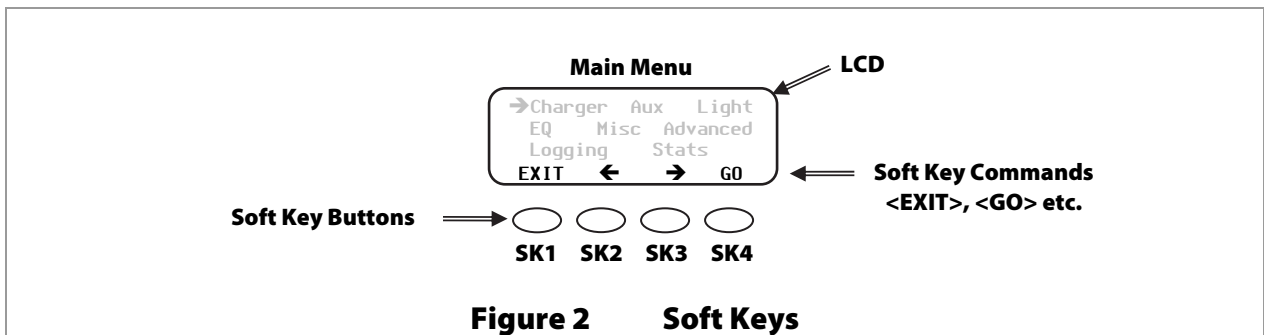



Installation

Standards and Requirements

All installations must comply with national and local electrical codes; professional installation is recommended.



IMPORTANT:

The charge controller is designed for indoor installation or installation inside a weatherproof enclosure. It must not be exposed to rain and should be installed out of direct sunlight.

Grounding

This product is intended to be installed as part of a permanently grounded electrical system as shown in the wiring diagrams shown in Figure 6, Figure 7, and Figure 8.

- The FLEXmax equipment ground is marked with this symbol:

The following important restrictions apply *unless superseded by local or national codes*:

- The negative battery conductor should be bonded to the grounding system at only *one* point in the system. If a GFDI is present, the battery negative and ground are not bonded together directly but are connected together by the GFDI device when it is on. All negative conductor connections must be kept separate from the grounding conductor connections.
- The FLEXmax controller is not intended to be wired into a positive-ground configuration. However, certain telecom applications may require this configuration. If it is necessary to build a positive-ground system with OutBack products, contact OutBack Technical Support at **+1.360.618.4363** before proceeding. Additionally, consult the online forum at **www.outbackpower.com/forum/**, where this subject has been discussed extensively.
- If damaged or malfunctioning, the FLEXmax should only be disassembled and repaired by a qualified service center. Please contact the local renewable energy dealer/installer for assistance. Incorrect reassembly risks malfunction, electric shock or fire.

DC and Battery-Related Installation Requirements

- Shut off all DC circuit breakers before connecting any wiring.
- Torque all the FLEXmax wire lugs and ground terminals to 4 Nm (35 in-lb).
- Copper wiring must be rated at 75°C or higher.
- Use up to 35 mm² (2 AWG) to reduce losses and ensure highest performance of the FLEXmax (smaller cables can reduce performance and possibly damage the unit).
- Run positive and negative cables side by side.
 - ~ Keep cables together (e.g., using a tie-wrap) as much as possible to allow the inductive currents to cancel.
 - ~ Ensure paired cables pass through the *same* knockout and conduit fittings.
- DC battery overcurrent protection must be used as part of the installation. OutBack offers both circuit breakers and fuses for overcurrent protection.

Dimensions

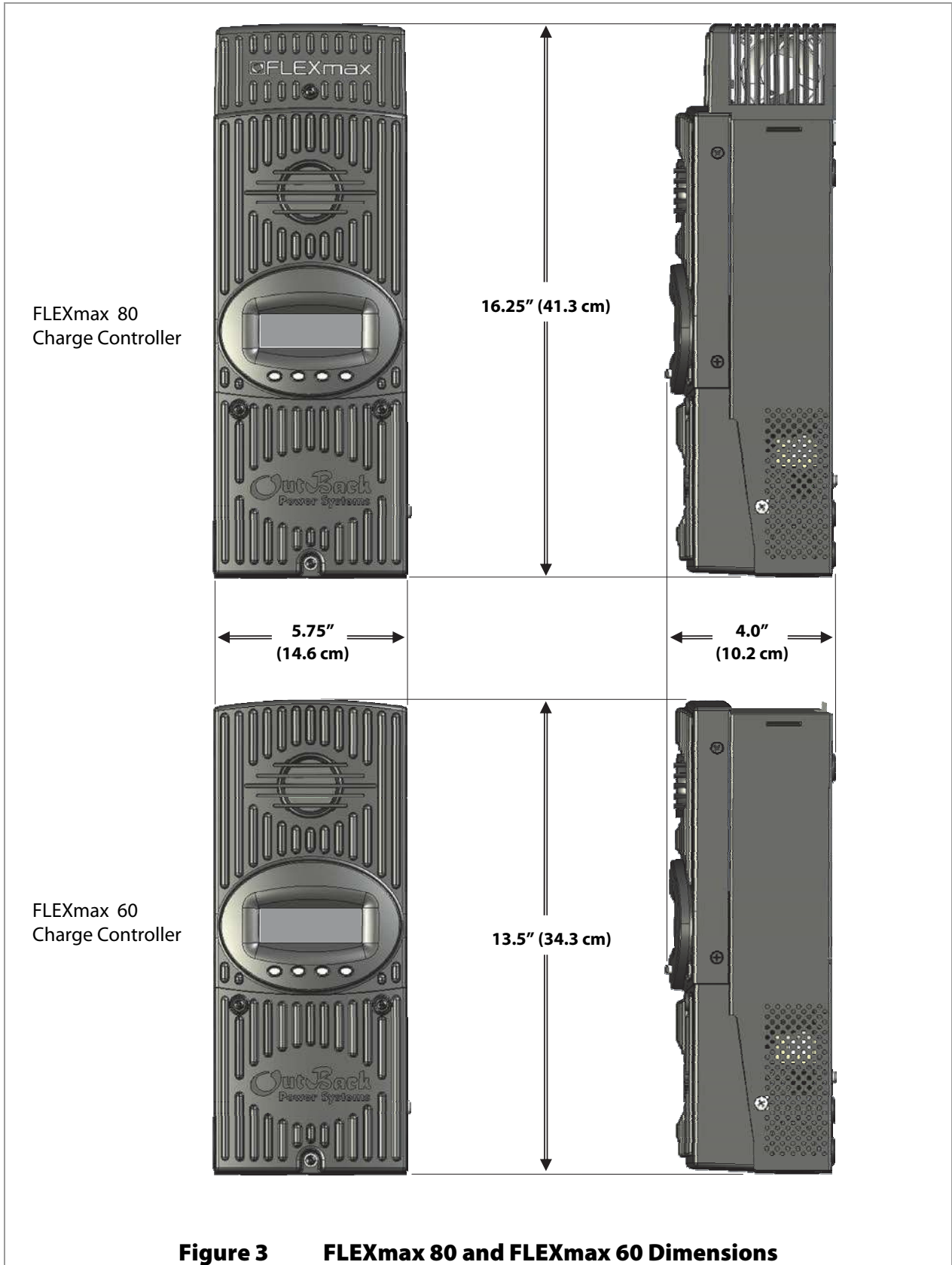

Mounting the Charge Controller



IMPORTANT:

Install the FLEXmax in an upright position out of direct sunlight.

The FLEXmax is designed to attach directly to OutBack’s FLEXware 500 DC and FLEXware 1000 DC enclosures (FLEXware 500 shown) or attach to its own charge controller brackets (FW-CCB, FW-CCB2, and FW-CCB2T).

Mounting directly to a FLEXware DC enclosure:

1. Remove the fan cover and bottom cover from the FLEXmax.
2. Insert a #10 X 3/8” sheet metal screw in the top hole on the side of the DC enclosure. This will act as a hanging screw for the keyhole slot at the top center of the FLEXmax.
3. Hang the FLEXmax on the top screw and line up its bottom two screw holes with the holes on the enclosure.
4. Insert a #10 x 3/8” sheet metal screw through each hole and tighten against the enclosure (screws are included with each DC enclosure).
5. Keep the cover off until wiring is completed.

The conduit nipple assembly creates a sealed connection from the FLEXmax to the enclosure.

Mounting to Plywood

Use 1-5/8” wood screws to secure the FLEXmax at the top slotted holes and other interior lower holes as needed, making sure the unit is straight and level.

Figure 4 Mounting the Charge Controller

Wiring

This section provides instructions on installing PV array wiring into the FLEXmax controller. See page 98 for more notes on PV array sizing and operation.

Wire and Disconnect Sizing



IMPORTANT:

- Wire sizes must comply with local and national codes. Input conductors and circuit breakers must be rated at 1.56 times the short-circuit current of the PV array (per NEC). OutBack 100% duty continuous circuit breakers only need to be rated at 1.25 times the short-circuit current.
- Copper wiring must be rated at 75°C or higher.
- Use up to 2 AWG (33.6 mm²) to reduce losses and ensure high performance of the FLEXmax (smaller cables can reduce performance and possibly damage the unit).

FLEXmax 80

- The output current limit of the FLEXmax 80 is 80 amps.
- Install OutBack PNL-80-DC circuit breakers for disconnect and overcurrent protection
- Use a minimum of #4 AWG (25 mm²) wire for the output between the FLEXmax 80 and the battery bus bar conductors.
- The largest PV array must have a rated short-circuit current of 64 amps or less under STC (Standard Test Conditions).
- Torque all the FLEXmax wire lugs and ground terminals to 4 Nm (35 in-lb).

FLEXmax 60

- The output current limit of the FLEXmax 60 is 60 amps.
- Install OutBack PNL-60-AC/DC or PNL-80-DC circuit breakers for disconnect and overcurrent protection.
- Use a minimum of #6 AWG (16 mm²) wire for the output between the FLEXmax 60 and the battery bus bar conductors.
- The largest PV array must have a rated short-circuit current of 48 amps or less under STC (Standard Test Conditions).
- Torque all the FLEXmax wire lugs and ground terminals to 4 Nm (35 in-lb).

Please refer to the NEC and other electrical codes for recommendations on PV array cable sizing and recommended length and ampacity.

Wiring Compartment



WARNING: Shock Hazard

Make sure all DC circuit breakers are OFF (open) BEFORE making any wiring connections. Use a DVM to check for voltage on all wires.

The PV (-) and BAT (-) terminals are connected internally. Only one negative wire may be needed to connect to the (-) wire lugs if the PV - and BAT- conductors are bonded at the negative bus bar.

See Figure 6, Figure 7, and Figure 8 for sample wiring diagrams.

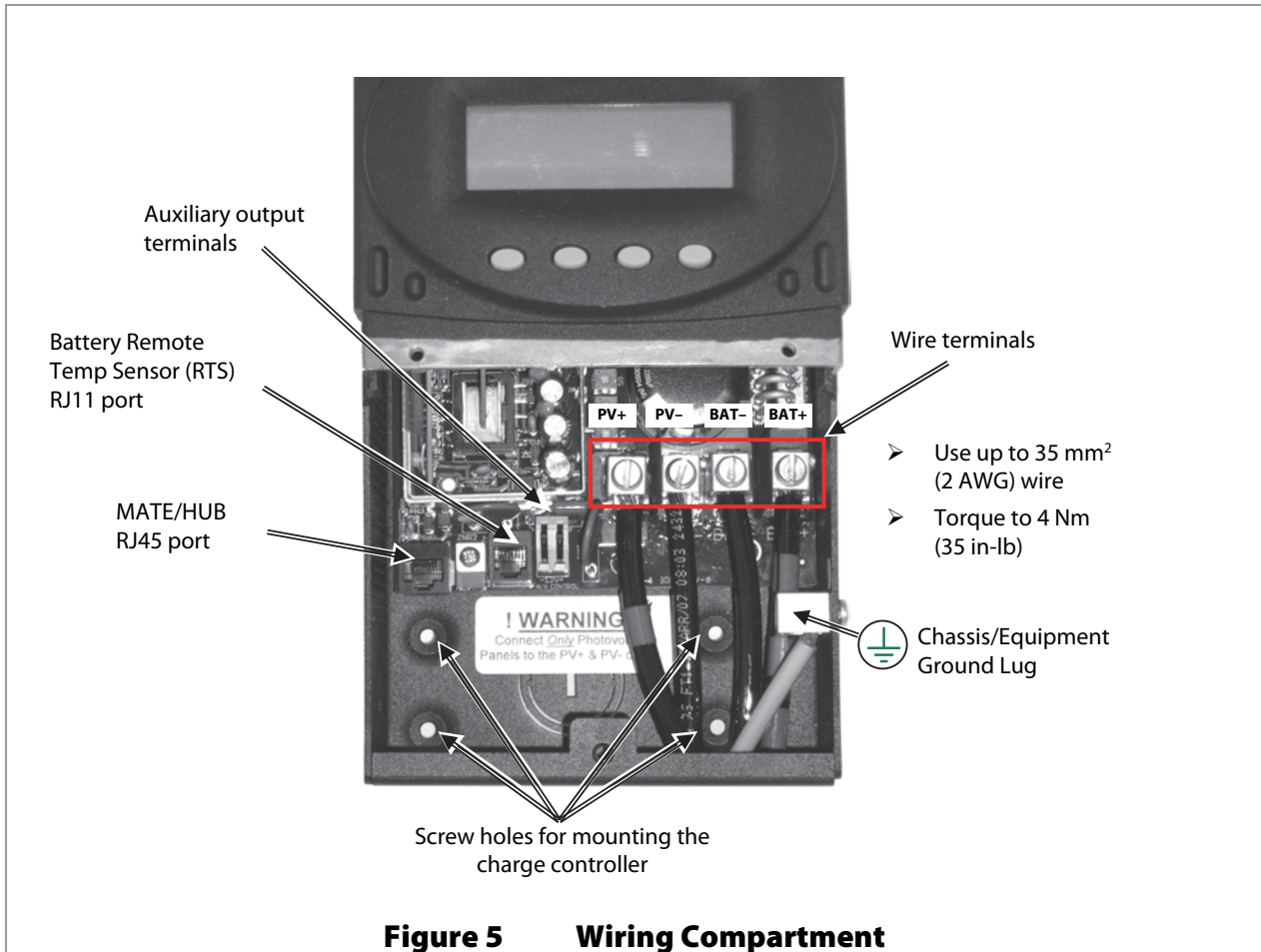

CAUTION: Equipment Damage

Each FLEXmax requires its own PV array. DO NOT PARALLEL FLEXmax PV+ and PV- TERMINALS ON THE SAME ARRAY!

An optional battery Remote Temperature Sensor (RTS) is recommended for accurate battery charging.

- Only one RTS is needed for multiple OutBack inverter/chargers and charge controller units when the system includes an OutBack HUB and a system display.
- When one RTS is used, it must be connected to the component plugged into the Port 1 of the HUB.

Installation

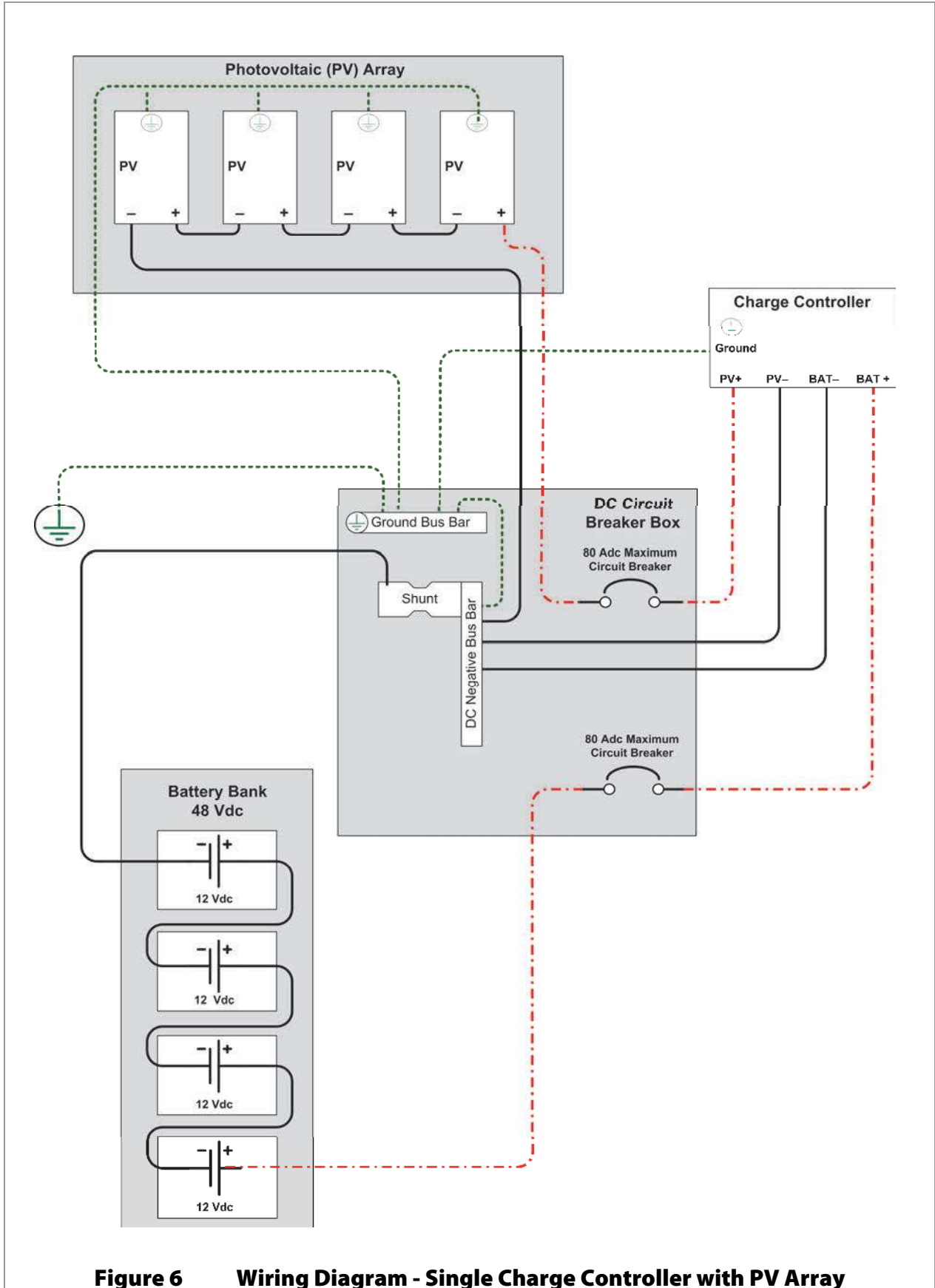

Figure 6 Wiring Diagram - Single Charge Controller with PV Array

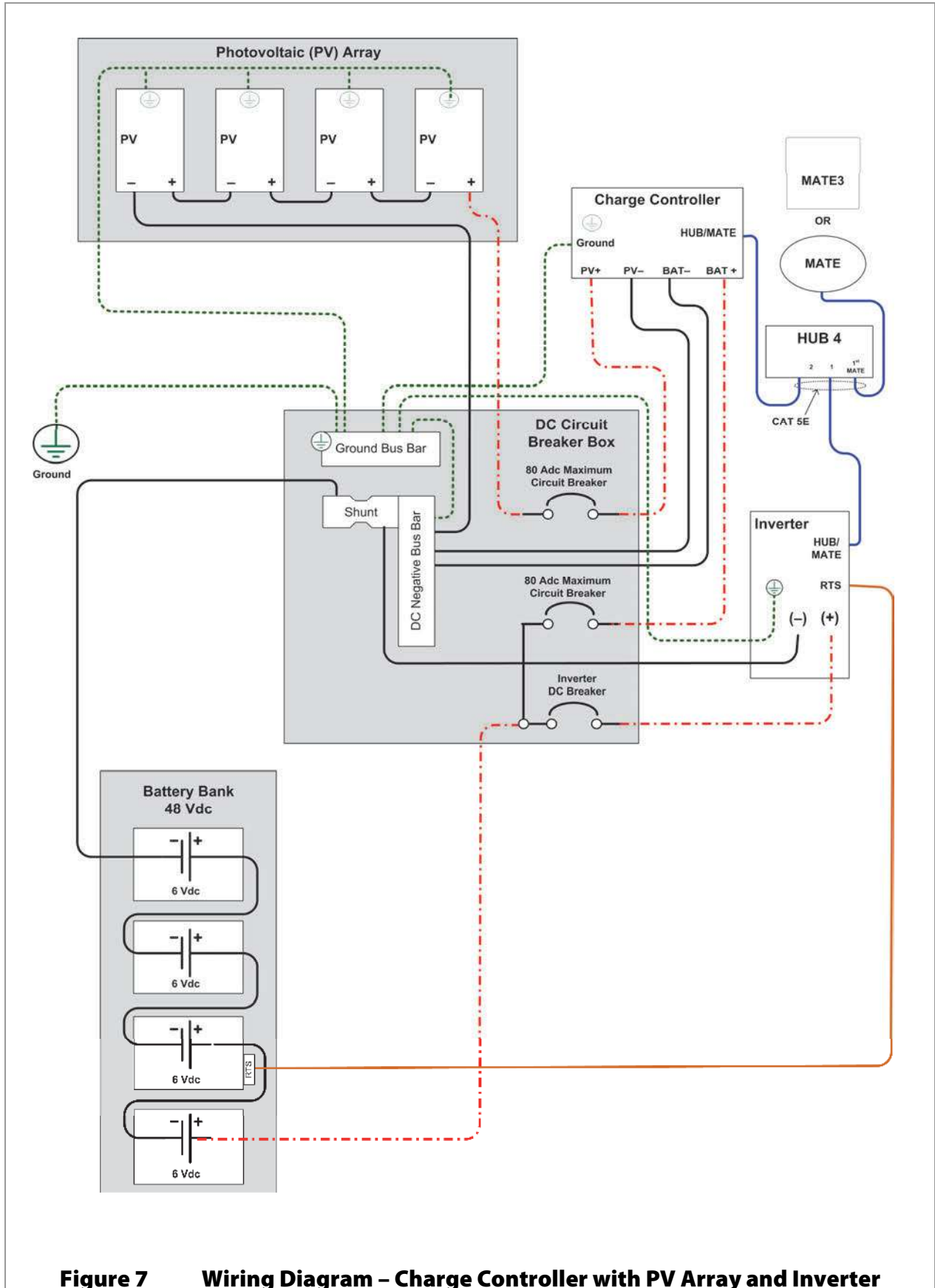

Figure 7 Wiring Diagram - Charge Controller with PV Array and Inverter

Installation

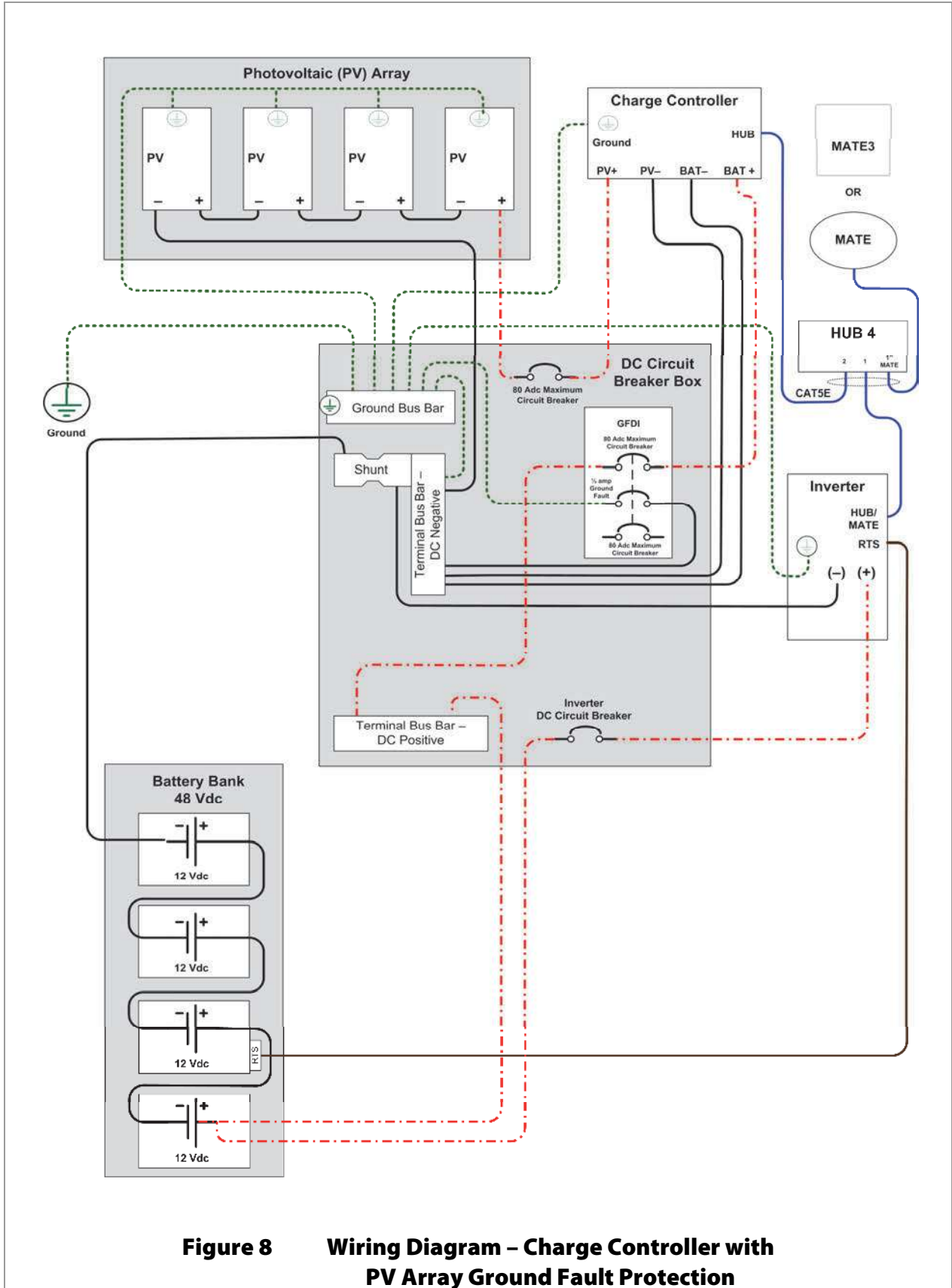

Figure 8 Wiring Diagram – Charge Controller with PV Array Ground Fault Protection



Operation

Operation of this unit consists of monitoring screens and programming screens. The majority of programming screens are accessed using the main menu. See page 24.

Power Up Screens



IMPORTANT:

- The default settings of the FLEXmax are for a 12 Vdc battery bank. Change the setting after powering up if a different battery voltage is used.
- Once set, the FLEXmax retains the nominal voltage setting. Following any type of shutdown or disconnect, it will return to operation automatically.
- The PV array voltage is automatically detected. The PV array voltage must never exceed 150 Voc.
- It is recommended to restore the FLEXmax to factory default settings (see page 53) and reset the nominal voltage any time the system is substantially revised or the controller is relocated.

The FLEXmax uses power from the battery bank to operate. The battery voltage must be at least 10.5 volts or higher to power up the FLEXmax. When battery power is detected, the FLEXmax will go through a series of power-up screens.

Power Up Screen

System Voltage (12V)

On Australian versions only (AU)

To change version settings:
While turning on the circuit breaker, press and hold the first and third soft keys. This brings up the **Select Version** screen. Changing the version settings requires entering a password.

NOTE: This process will reset the FLEXmax to its default settings. It may be necessary to re-enter previous settings.

To change the system password:

1. Press <NEXT> or <SEL> when the **Select Version** screen appears on power up. This will open the **PASSWORD** screen.
2. Press <-> or <+> to reduce the number from 150 to **141**.
3. Press <ENTRA> or <ENTER> to enter the new password.

To power up the charge controller:

1. Ensure the PV array and battery circuit breakers are OFF.
2. Turn ON the battery circuit breaker only.
 - The FLEXmax will show the system battery voltage in the upper right corner of the screen. If the screen reads **Low Battery Voltage**, please see the Troubleshooting section on page 91.
 - If the Australian version was previously selected, AU will be displayed in the lower right corner of the screen.

PASSWORD Screen

Continued on next page...

Figure 9 Powering up the FLEXmax

Select Version offers two types of options. The English (default) or Spanish selections offer standardized charge settings in two languages. Selecting Australian leaves the menus in English, but changes the charging parameters. (For details, see Table 6 on page 99.)

Version and/or Voltage Setting Screens

Once the password has been entered, the display will return to the **Select Version** screen.

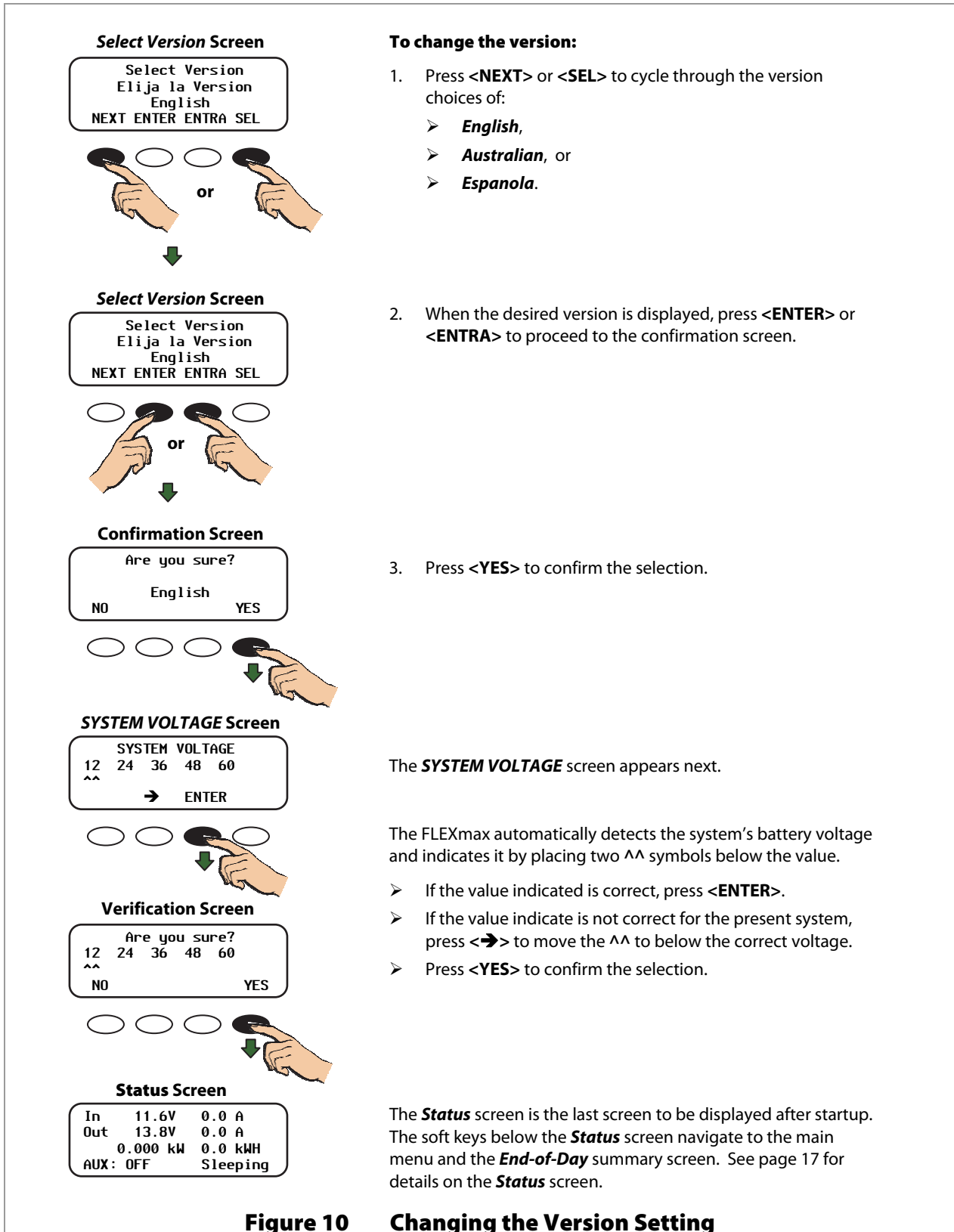

Figure 10 Changing the Version Setting

Status Screen

The status screen displays system information. See page 18 for detailed information of the different modes of operation.

The optional OutBack system display shows CC (Charge Controller) status screens for convenient distant viewing from the installation location. See page 59 for the FLEXmax screens displayed on the MATE3. Please see pages 71 to 83 to view the FLEXmax screens displayed on the MATE (or MATE2).

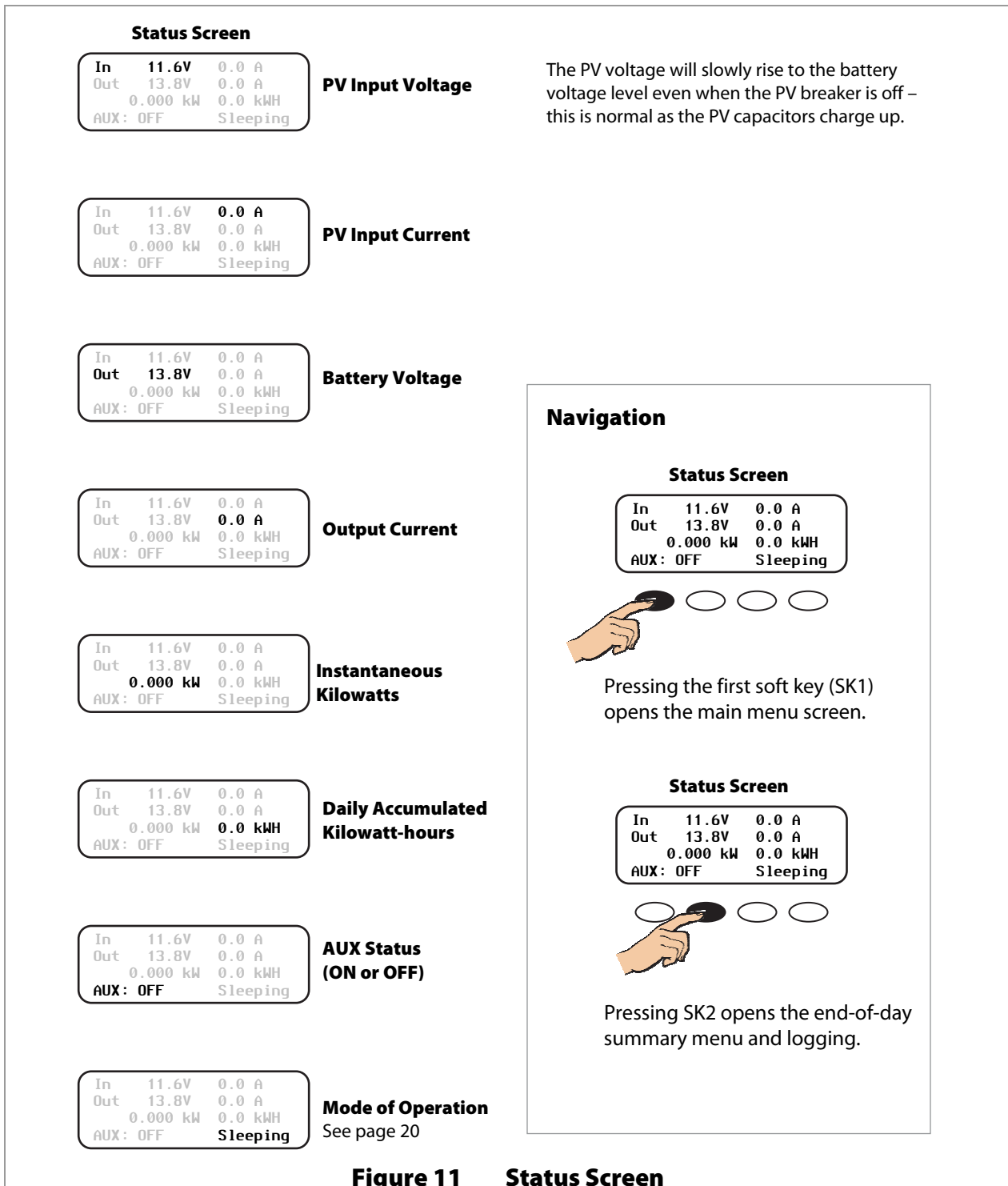

Figure 11 Status Screen

End-of-Day Summary Screen

The end-of-day summary screen appears after one hour of continuous Sleeping (see page 23). This screen can be opened any time by pressing the second soft key while in the status screen, providing a summary up to that point.

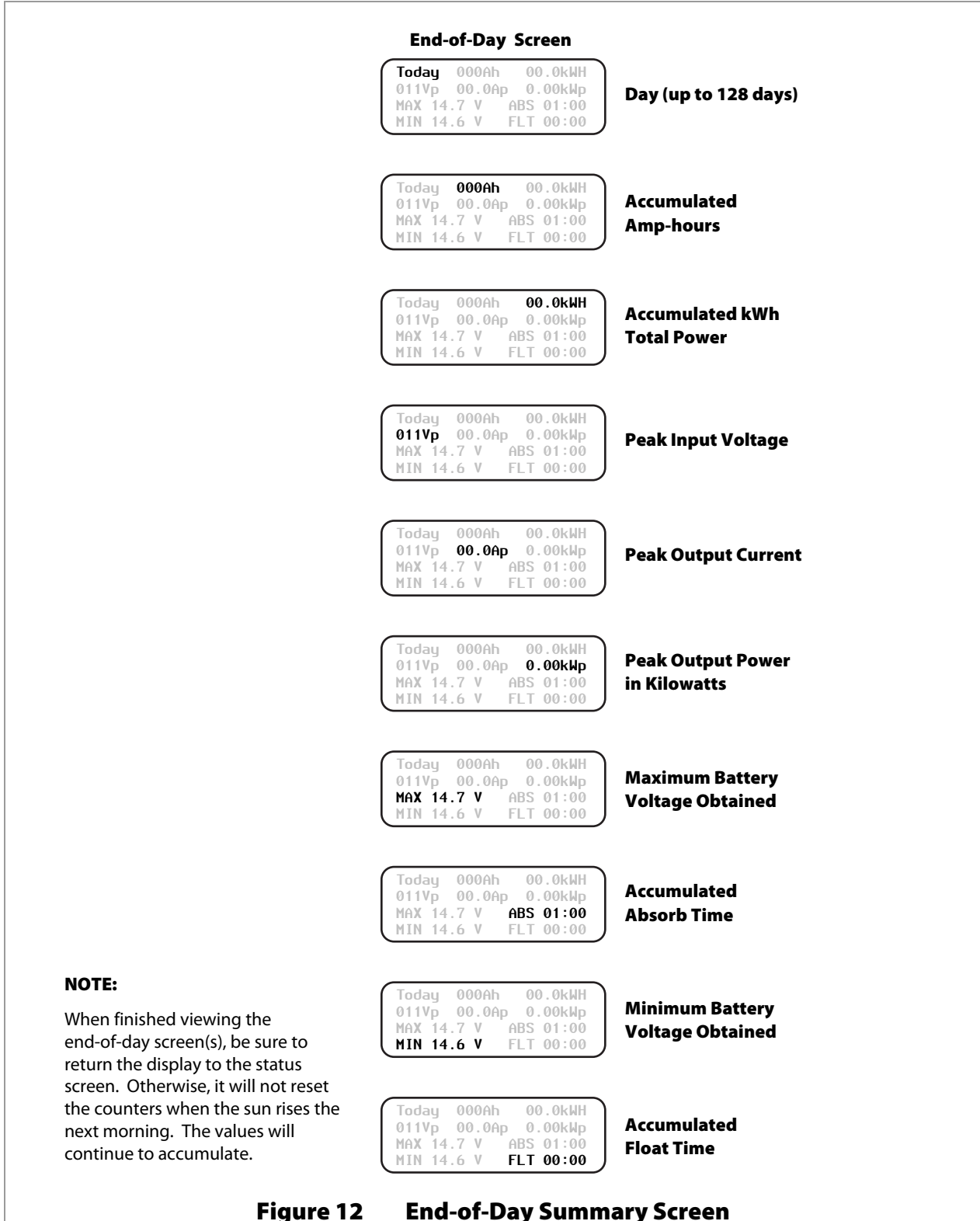

Figure 12 End-of-Day Summary Screen

Navigating the End-of-Day Screens and Data Logging

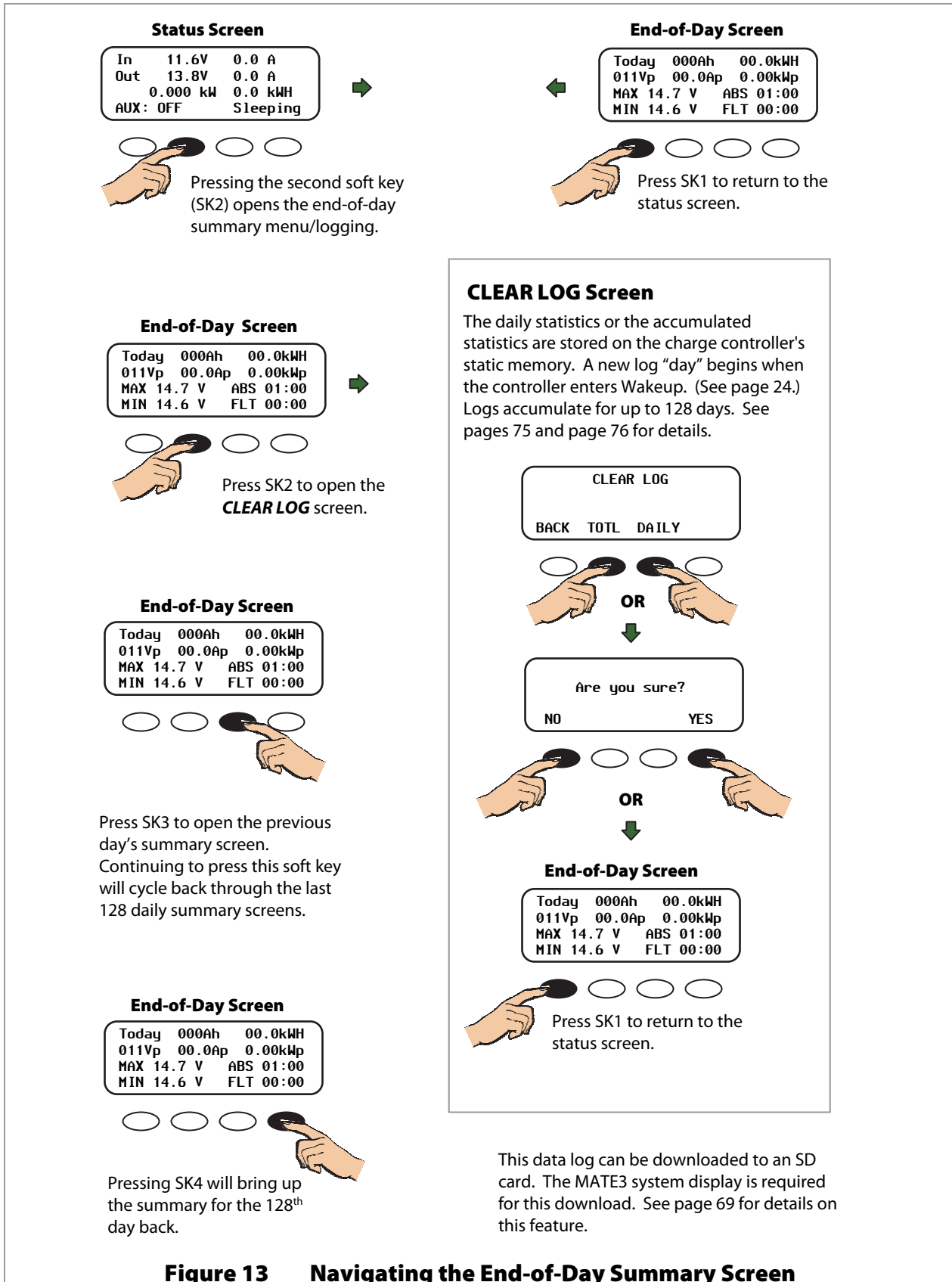

Figure 13 Navigating the End-of-Day Summary Screen

Modes of Operation

The FLEXmax has 25 different modes that will display on the status screen. These messages will vary with function. The FLEXmax modes consist of various charging stages, equalization, various reasons for stopping charging, and certain specialized operating modes.

The amount of time required before starting operation is dependent on the module type, ambient temperature, and the amount of sunlight directly on the PV array. Normally, the FLEXmax starts in the morning within a few minutes of the PV array being exposed to direct sunlight.

The FLEXmax modes of operation will change occasionally during the day based on the PV array output and the battery system state of charge. The FLEXmax operating modes are displayed at the bottom right hand corner of the status screen. See Figure 11.

Figure 14 shows an example of the various stages of operation during battery charging and the messages shown during each stage. Battery charging is described in detail on page 96.

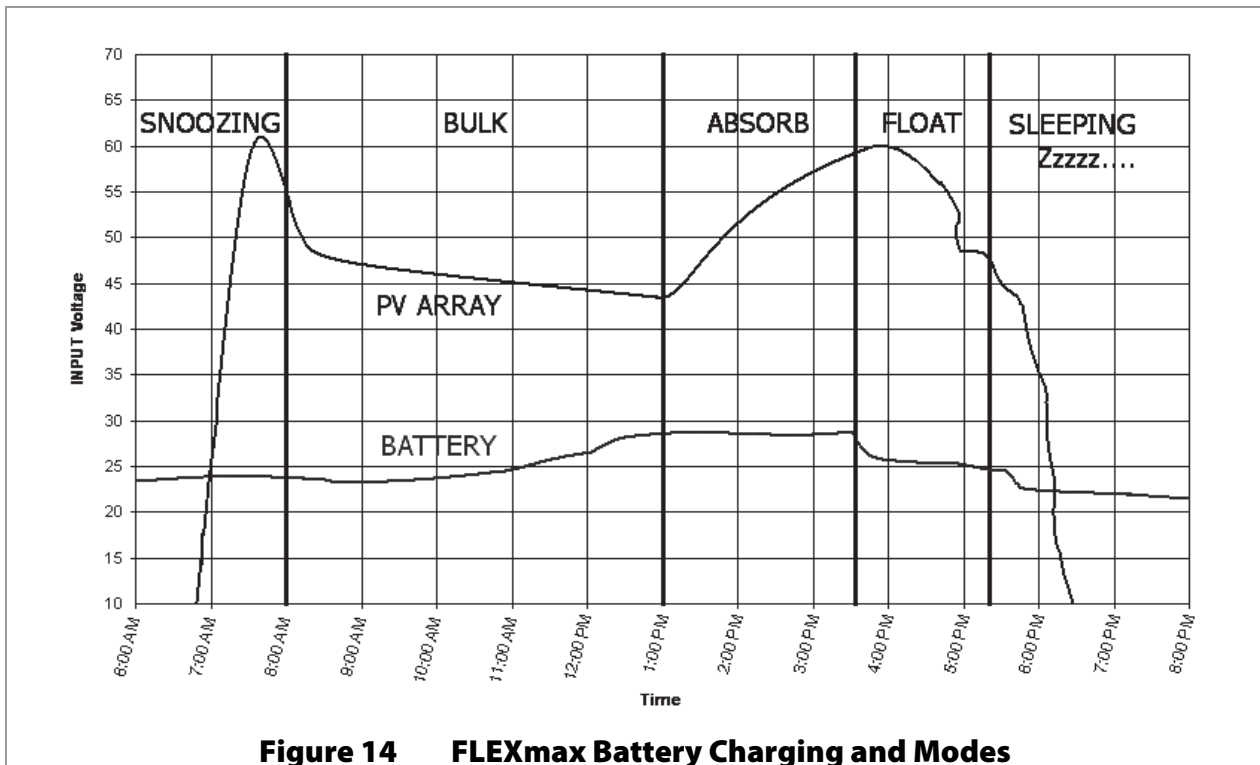

Figure 14 FLEXmax Battery Charging and Modes

Absorbing

The FLEXmax is in the Absorbing stage of a three-stage cycle, regulating the battery voltage at the **Absorbing** voltage set point. While the batteries are held at this voltage, the **ChgT** counter in the **Misc** menu counts up from zero toward the user-defined **Absorb Time Limit**. (See pages 44 and 49.) The charger will exit this stage and enter the Float stage if the **ChgT** timer reaches the time limit, or if the **Absorb End Amps** setting is reached. (See page 49.)

If the battery voltage drops below the **Absorbing** voltage (see page 26), the FLEXmax reverts back to the Bulk charge stage and displays **MPPT Bulk** as shown on page 22. The **ChgT** counter will begin counting back toward zero. Lower voltages will cause the timer to subtract minutes at a faster rate, as shown on Table 1 on page 21.

Table 1 Battery Voltage and Charge Timer

Battery Voltage	ChgT (Charge Timer) Activity/Display
≥ 12.4 V, 24.8 V, 37.2 V, 49.6 V, or 62.0 V, and less than the Absorbing voltage	No change.
<12.4 V, 24.8 V, 37.2 V, 49.6 V, or 62.0 V	For every minute elapsed, 1 minute is subtracted from the timer
<12.0 V, 24.0 V, 36.0 V, 48.0 V, or 60.0 V	For every minute elapsed, 2 minutes is subtracted from the timer
< 11.6 V, 23.2 V, 34.8 V, 46.6 V, or 58.0 V	For every minute elapsed, 4 minutes is subtracted from the timer.

Auto Start (Auto ReStart)

This setting allows the user to choose between continuous MPP tracking or occasional restarts of the sweeping process. A restart means the controller abandons the existing maximum power point and “re-sweeps”, or begins gathering new power point data. See page 52 for more information.

- Mode 1: Once every 1.5 hours in the Bulk charging stage
- Mode 2: Once every 1.5 hours in the Bulk, Absorbing and Float recharging stages
- Mode 0: Auto ReStart is disabled completely. It will continuously track the maximum power point without starting over.

NOTE: If enabled, **AutoStart** also occurs during the **MPPT EQ** cycle. See page 23.

BatTmpErr

The battery temperature sensor is shorted or damaged. The charging voltage will not be temperature compensated and the cooling fan will continuously operate. See the section on RTS compensation on page 50.

BatTooHot

The battery temperature sensor has detected a battery temperature of over 50°C. The FLEXmax will stop charging the battery and wait for the battery to cool below 50°C.

Charged

There is an external DC source other than PV keeping the battery above the **Float** voltage set point (see page 26). The FLEXmax will stop charging because it is not needed. The display may also appear when the cycle is transitioning from **Absorbing** (upper target voltage) to **Floating** (lower voltage).

EQ

The charger is in a cycle of equalization. (See page 42.) This is the time elapsed in hours and minutes since the **BATTERY EQUALIZE VOLTS** set point was met.

If this set point is not maintained, the controller will revert back to **MPPT EQ**. (See page 23.) The EQ timer will pause until the batteries are regulated at the **BATTERY EQUALIZE VOLTS** set point again. The paused time can be viewed in the **End-of-day Summary** screen (see page 18).

EQ Done

Once the set EQ time (between 1 and 7 hours) has successfully completed, the FLEXmax will transition to Float stage. **EQ Done** will be displayed either until a button is pressed or the next morning’s wakeup. The FLEXmax will transition to **Float** stage at the end of the completed equalization cycle.

EX-Absorb

There is an external DC source other than PV keeping the battery above the **Absorbing** voltage set point. The FLEXmax will stop charging because it is not needed.

Floating

The FLEXmax is in the **Float** stage of a three-stage cycle, regulating the battery voltage at the **Float** voltage set point. This stage is temperature compensated. (See page 97.) If the battery voltage drops below the **Float** voltage, the FLEXmax will employ the MPPT function to draw more power from the PV array. (This may occur if the batteries are powering loads.) If this happens, the operating mode will change to **MPPT Float**. (See below.)

GT Mode

The FLEXmax is in Grid-Tie mode. In a system with an OutBack grid-interactive inverter, a HUB, and a system display, the FLEXmax will display **GT Mode**, if and only if, the inverter is in Sell mode and the FLEXmax is in the **MPPT BULK** or **MPPT FLOAT** modes. This message also indicates that Grid-Tie mode communication has been established between the inverter and charge controller. **GT** must be selected in the **MPPT Mode** advanced menu in order to be viewed. (See page 47.)

High Voc

This indicates the PV array's open-circuit voltage is too high for the controller to safely operate (> 145 Vdc). This should only occur with systems using 72 Vdc nominal PV arrays in very cold temperatures (below -15°C / 5°F). The FLEXmax will automatically restart operation once the PV array's open-circuit voltage falls to a safe level (145 Vdc or lower).



CAUTION: Equipment Damage

Voltages in excess of 150 Vdc are likely to damage the FLEXmax controller. The PV array should be designed to avoid ever reaching these voltages.

Low Light or Snoozing

A **Low Light** or **Snoozing** mode indicates that the PV voltage is high enough to activate the FLEXmax, but there is not enough current available to charge. During the initial tracking (see **Wakeup** and **Tracking**), if it is determined to be too late (or too early) in the day, the FLEXmax will display **Low Light** for a few seconds and then display **Snoozing** for five minutes (default). This reduces energy usage and unnecessary powering of the FLEXmax. This message is also displayed in extremely cloudy weather.

MPPT Bulk

This is a Maximum Power Point Tracking mode which harvests the maximum wattage available from the PV array. The controller is trying to regulate the battery voltage towards the **Absorbing** voltage set point. Normally the charge controller enters this mode at the beginning of the day or when a new charge cycle begins. The controller may also enter this stage if there is not enough PV energy to maintain a different stage, such as **Absorbing**. See page 20 for more information.

MPPT Float

This is a Maximum Power Point Tracking mode which harvests the maximum wattage available from the PV array. The controller is trying to regulate the battery voltage towards the **Float** voltage set point. Normally, the charge controller enters this mode if it was in the **Floating** mode (see above) and there was not enough energy to maintain the battery voltage.

MPPT EQ

The equalization cycle has started and the charge controller is trying to regulate the batteries at the **BATTERY EQUALIZE VOLTS** set point. Once this voltage has been reached, the displayed mode will change to **EQ**.

Before equalizing, battery loads should be turned off and the battery should be charged so the charge controller can quickly reach the EQ voltage set point. Otherwise, the charge controller may have difficulty reaching or maintaining the equalization process.

Equalization is not battery temperature compensated.

New Voc

The FLEXmax is measuring a new open-circuit panel voltage (Voc). This mode tells the user that external conditions have changed. After displaying this message, the charge controller will enter **Tracking** mode to perform power point tracking again.

OvrCurrent

This condition occurs if more than 6 amps flows from the battery to the FLEXmax, or if more than 100 amps is drawn from the FLEXmax by the battery. To reinitiate power production, press **<RSTRT>** in the **Misc** menu (see page 45). If this continues to occur, the unit may be malfunctioning.

Over Temp

The FLEXmax is too hot. If this message appears, carefully check to see if the heat sink is extremely hot. To help control its operating temperature, avoid installing the FLEXmax in direct sunlight.

Re-Cal

There are certain conditions that can confuse the current measuring method in the FLEXmax. If this happens, the FLEXmax will temporarily stop and re-calibrate. This may happen because of high temperatures or current flowing from the battery. After displaying this message, the charge controller will enter **Tracking** mode to perform power point tracking again.

Sleeping

The PV voltage is two volts less than the battery voltage. This normally appears at night, when no PV energy is available. This may also appear during the day when the FLEXmax is transitioning between certain states, or due to other conditions. After three hours of **Sleeping**, the FLEXmax will transition to **Zzzzz...** mode.

Sys Error

This indicates an internal non-volatile memory error. The unit will stop operating when this message is displayed. Call OutBack Technical Support if this message appears (+1.360.618.4363).

Tracking

In **Tracking** mode, the FLEXmax is doing an initial tracking of the panel voltage from Voc towards battery voltage after wakeup. This is also displayed when the controller transitions from a target set point (**Absorbing**, **Floating**, or **EQ**) to the MPPT state (**MPPT Bulk**, **MPPT Float**, or **MPPT EQ**).

Unloaded

The battery terminals have become disconnected. This may mean that the battery circuit breaker breaker has tripped. It can also appear if the nominal battery voltage is set too low.

Wakeup

As the PV open circuit voltage (Voc) rises above the battery system voltage by two volts, the FLEXmax prepares to deliver power to the batteries, although it does not perform MPPT in this mode. During this period (initial tracking), the FLEXmax is calculating the PWM duty cycles, turning on power supply voltages in the proper sequences, and making internal calibrations. It also measures a new Voc at this time. In **Wakeup**, the daily statistics of a single FLEXmax (amp-hours, kilowatt-hours, etc.), will accumulate into the total statistics. The daily statistics and the end-of-day summary will clear, and the controller will begin logging a new "day". A FLEXmax combined with a HUB and a MATE will log this information at midnight. On the MATE3, the data logging will occur at the interval scheduled in the MATE3 data logging parameters.

Zzzzz...

The FLEXmax will display **Zzzzz...** after 3 hours of continuous **Sleeping**. This transition indicates that the controller recognizes it is night. It will perform **Wakeup** when voltage is available (see above).

Initial Operation

Status Screen

In	113.6V	0.0 A
Out	12.5V	0.0 A
	0.000 kW	0.0 kWh
AUX:	OFF	Sleeping

○ ○ ○ ○

Status Screen

In	000.0V	0.0 A
Out	12.5V	0.0 A
	0.000 kW	0.0 kWh
AUX:	OFF	Sleeping

○ ○ ○ ○

Turn the PV input circuit breaker ON. The FLEXmax automatically detects the PV input voltage.

The FLEXmax enters **Wakeup**, transitions to **Tracking**, and prepares to charge the batteries by tracking the maximum power point of the solar array.

During the initial tracking, the input PV source is gradually loaded from the open-circuit voltage (Voc) to ½ of the Voc. Within this range, the FLEXmax seeks the maximum power point.

When the FLEXmax goes into **Re-Cal**, **Auto Restart**, or **Wakeup**, modes, among other conditions, it performs an initial tracking.

If PV voltage registers **000V** when the PV circuit breaker is ON, check the polarity of the PV connections.

Figure 15 Initial Operation

Changing the Settings on the FLEXmax

Accessing the Main Menu

The main menu allows the user to adjust and calibrate the FLEXmax for maximum performance.

From the status screen, press SK1 to open the main menu screen.

To return to the status screen from the main menu, press <EXIT> (also SK1).

Status Screen

In	113.6V	0.0 A
Out	12.5V	0.0 A
	0.000 kW	0.0 kWh
AUX:	OFF	Sleeping

○ ○ ○ ○

→

Main Menu

→Charger	Aux	Light
EQ	Misc	Advanced
Logging	Stats	
EXIT ←	→	GO

← ○ ○ ○ ○

Figure 16 Accessing the Main Menu

Main Menu Map

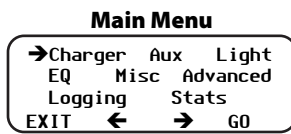

<EXIT> returns to the **Status** screen.
 <←> moves the cursor to the left.
 <→> moves the cursor to the right.
 <GO> goes to the setup screen for the chosen option.



From the main menu, a user can choose among the following FLEXmax functions by aligning the arrow next to the desired selection.

- **Charger**—CHARGER SETUP
 Adjusts the **Current Limit**, **Absorbing**, and **Float** recharging voltage set points.
 See page 26 for details.
- **Aux**—AUX OUTPUT CONTROL
 Provides a secondary control circuit for a vent fan, error alarm, and other system-related additions.
 See page 27 for details.
- **Light**—BACKLIGHT CONTROL
 Adjusts the backlighting of LCD screen and soft key buttons.
 See page 41 for details.
- **EQ**—BATTERY EQUALIZE
 Activates battery equalization recharging (manually or automatically).
 See page 42 for details.
- **Misc**—MISCELLANEOUS
 Additional settings and service information.
 See page 44 for details.
- **Advanced** —ADVANCED MENU
 Optimizes/fine-tunes the charge controller.
 See page 46 for details.
- **Logging**—DATA LOGGING
 Displays recorded power production information.
 See page 54 for details.
- **STATS**—STATISTICS
 Displays recorded peak system information and cumulative kilowatt-hours and amp-hours.
 See page 55 for details.

Figure 17 Main Menu

Charger Screen

Charging settings should follow the battery manufacturer's recommendations. This screen allows changes to the recharging voltage set points if the default settings do not match the manufacturer's recommendations. (For an explanation of battery charging, see pages 96 and 97).

- **Current Limit**
- **Absorbing**
- **Float**

The default charger output current limit setting is:

- 80 amps for the FM80, and
- 60 amps for the FM60.

This setting is adjustable from 5-80 amps.



IMPORTANT:

- Check the battery manufacturer's recommendations for the optimal charging settings for the type of batteries being used.
- An appropriate circuit breaker, or overcurrent device, must be used between the battery and the FLEXmax.
- If a battery remote temperature sensor (RTS) is used, set the **Absorbing** and **Float** setting voltage based on a 25°C/77°F setting. RTS compensated voltage values can be viewed in the **Advanced** menu screen under the **RTS Compensation** heading.

Main Menu

→Charger	Aux	Light
EQ	Misc	Advanced
Logging	Stats	
EXIT ←		→ GO

○ ○ ○ ○

→Charger Aux Light
EQ Misc Advanced
Logging Stats
EXIT ← → GO

○ ○ ○ ●

↑ ↓

Charger Screen

Current Limit →	80A
Absorbing	14.4V
Float	13.8V
EXIT ↓	- +

○ ● ● ●

↑

To access the Charger screen and adjust the settings:

1. From the main menu, press the <←> or <→> soft key to move the → to the left of the **Charger** function.
2. Press <GO> to open the **Charger** screen. The → indicates which set point is selected.
3. Press <↓> to move the → to the set point that needs to be changed.
4. Press <+> to increase the value or <-> to decrease the value.

To Exit:

- Press <EXIT> once to return to the main menu.
- Press <EXIT> twice to return to the status screen.

Figure 18 **Charger Setup Menu**

Aux Screens

The AUX (Auxiliary) is a secondary control circuit — essentially, a small power supply that provides a 12 Vdc output current (up to 200 milliamps/2.4 watts) to an isolated load. It is either **ON (Active High)** with 12 Vdc available at the output or **OFF (Active Low)** with 0 Vdc at the output. It can also be set to **AUTO**, so that it activates when certain criteria are met.

The AUX output can respond to specific criteria and control cooling fans, vent fans, load diversion, fault alarms, and automatic generator control. In some cases, such as the **PV Trigger**, **Night Light**, or **Diversion:Relay** applications, the polarity of the output can be reversed so that a lack of power activates the output. This function is controlled through the **Aux Polarity** screen in the **ADVANCED MENU**. (See page 53.)

NOTE: **Diversion:Relay** and **Diversion:Solid St** can be used for AC coupling applications.

The AUX output can also be controlled externally through the system display. See the *Owner's Manual* for the system display (if used) for details.

- Only one **AUX MODE** can operate at a time (even if other modes have been preset).
- See Figure 27, page 39, for an auxiliary setup wiring diagram example.

Table 2 Aux Mode Functions

Mode Name	Function/Purpose	Set Points	Aux Polarity
Vent Fan	<p>Function: When the threshold voltage set point is exceeded, the AUX output will change state for at least 15 seconds. If the set point continues to be exceeded, the output will remain in that state until the voltage falls below the set point.</p> <p>Once the voltage decreases below the threshold voltage, the AUX output will remain in that state for another 15 seconds. It will then deactivate.</p> <p>Purpose: This mode is intended to operate a vent fan for a battery enclosure to ventilate hydrogen gas from the enclosure.</p>	<ul style="list-style-type: none"> ➤ Threshold Voltage 	Not Available
PV Trigger	<p>Function: When the threshold voltage set point is exceeded, the AUX output will activate.</p> <p>When the threshold voltage decreases below the voltage set point, the output will remain active for the duration of the hold time set by the user.</p> <p>Purpose: This mode is intended to operate an alarm, or relay that disconnects the PV array, when PV input exceeds the threshold voltage set by the user. The mode deactivates the alarm or PV disconnect after the time set point has been reached.</p> <p>NOTE: Do not exceed 150 Vdc or the FLEXmax could be damaged.</p>	<ul style="list-style-type: none"> ➤ Threshold Voltage ➤ Hold Time 	<p><i>Active High:</i> Activates the output when the voltage exceeds the set point.</p> <p><i>Active Low:</i> Deactivates the output when the voltage exceeds the set point.</p>

Table 2 Aux Mode Functions

Mode Name	Function/Purpose	Set Points	Aux Polarity
Error Output	<p>Function: When the voltage decreases below the threshold voltage for 10 minutes or more, the AUX output will change state.</p> <p>Purpose: This mode is useful for monitoring remote sites. It is intended to signal when the charge controller has not charged the batteries for 26 hours or more or if the battery voltage has fallen below the threshold voltage for more than 10 minutes. When set as Active Low, it can activate an alarm by sending a signal through a modem to a computer to alert the operator of the problem.</p>	<ul style="list-style-type: none"> ➤ Threshold Voltage 	Not Available
Night Light	<p>Function: When the voltage drops below the threshold voltage set point for the amount of time set in the Hysteresis time, the AUX output changes states and remains in that state for the amount of time set for the ON time.</p> <p>Purpose: This mode is intended to illuminate a user-provided, low wattage light for as long as the charge controller remains in Sleep mode or for the ON time set by the user.</p>	<ul style="list-style-type: none"> ➤ Threshold voltage ➤ ON Time ➤ Hysteresis Time 	<p><i>Active High:</i> Activates for a set amount of time when the voltage drops below the threshold for a set amount of time.</p> <p><i>Active Low:</i> Deactivates for a set amount of time when the voltage drops below the threshold for a set amount of time.</p>
Float	<p>Function: When the FLEXmax is in the Float stage, the output activates to power a load.</p> <p>Purpose: This mode is intended to power a load when the FLEXmax is in the Float stage of charging the batteries.</p>	None	Not Available
Diversion: Relay	<p>Function: When the battery voltage exceeds the threshold voltage, the AUX output changes state. Often used with wind or hydroelectric sources.</p> <p>Purpose: This mode is intended to divert power from the batteries to prevent overcharging by activating a diversion load at the appropriate time.</p>	<ul style="list-style-type: none"> ➤ Threshold Voltage ➤ Time 	<p><i>Active High:</i> Controls an auxiliary load to divert power away from the batteries when a wind or hydroelectric turbine is connected directly to the batteries.</p> <p><i>Active Low:</i> Deactivates an auxiliary load to stop diverting from batteries.</p>
Diversion: Solid St	<p>Function: When the battery voltage exceeds the threshold voltage, the AUX output goes into pulse-width modulation at a rate of 200 Hz. Often used with wind or hydroelectric sources.</p> <p>Purpose: This mode is intended to divert power from the batteries to prevent overcharging by operating a diversion load at the appropriate PWM level. Recommended for use with a solid-state relay for fast and precise load control.</p>	<ul style="list-style-type: none"> ➤ Threshold Voltage ➤ Time 	Not Available

Table 2 Aux Mode Functions

Mode Name	Function/Purpose	Set Points	Aux Polarity
Low Battery Disconnect	<p>Function: When the battery voltage falls below the threshold disconnect voltage, the AUX output activates. When the battery voltage rises above the threshold reconnect voltage, the AUX deactivates.</p> <p>Purpose: This mode is intended to operate a relay to turn off loads and save battery capacity.</p>	<ul style="list-style-type: none"> ➤ Threshold Voltage for disconnect ➤ Threshold voltage for reconnect ➤ Time delay 	Not Available
Remote	Allows an OutBack system display to control the AUX output (see the system display manual for details).	None	Not Available

AUX MODE Screen Navigation

Main Menu

```

➔Charger Aux Light
EQ Misc Advanced
Logging Stats
EXIT ← → GO
    
```

Charger →Aux Light
EQ Misc Advanced
Logging Stats
EXIT ← → GO

AUX MODE Screen

```

AUX MODE ↑
Night Light
Output: Off Off
EXIT NEXT SET MODE
    
```

AUX MODE Set Point

```

AUX MODE ↑
Night Light
Output: Off Off
EXIT NEXT SET MODE
    
```

To access the AUX MODE screen and adjust the settings:

- From the main menu, press <←> or <→> to move the ➔ to the left of **Aux**.
- Press <GO> to open the **Aux** screen.
- Press <NEXT> to cycle through the available auxiliary modes.
- Press <MODE> to cycle through the mode set points **ON**, **OFF**, or **AUTO**. In **AUTO** mode, the function will automatically activate when a user-determined value is met and deactivate (or shut down) when other conditions are met, such as a certain amount of time passing.
- Press <SET> to select the set point(s) (if available).
- Press <EXIT> once to return to the main menu.
- Press <EXIT> twice to return to the status screen.

NOTE: If more than 10 minutes have passed since any activity, the PASSWORD screen becomes active, requiring the user to reenter the password (141).

Figure 19 Aux Screen Navigation

Vent Fan (AUX Mode)

This mode is intended to operate a vent fan for a battery enclosure which helps ventilate hydrogen gas from the enclosure. If the voltage remains above the threshold voltage set point, the vent fan will remain active.

When the voltage falls back below the set point, the vent fan will continue for another 15 seconds, then turn off.

Main Menu

→Charger Aux Light
EQ Misc Advanced
Logging Stats
EXIT ← → GO

Charger →Aux Light
EQ Misc Advanced
Logging Stats
EXIT ← → GO

AUX MODE
Vent Fan
Output: Off Off
EXIT NEXT SET MODE

<NEXT> advances to the next **AUX MODE** screen.

AUX MODE
Vent Fan
Output: Off Off
EXIT NEXT SET MODE

AUX MODE
Vent Fan
EXIT VOLT

VENT FAN VOLTS
> 14.4
BACK - +

To set the mode for Vent Fan:

- From the main menu, press <←> or <→> to move the → to the left of **Aux**.
- Press <GO> to open the **AUX MODE** screen.
- The **Vent Fan** screen should be the first default screen to display. If any other mode screen is displayed, press <NEXT> to cycle through the available modes until **Vent Fan** is displayed again.
- Press <MODE> to switch between **ON**, **OFF**, or **AUTO**.
 - **ON** activates the AUX output.
 - **OFF** deactivates the AUX output.
 - **AUTO** controls the output according to the criteria of the selected AUX mode.

To change the set points for Vent Fan:

- Press <SET> to advance to the set point screen.
- Press <VOLT> to advance to the **VENT FAN VOLTS** screen.
- Press <-> or <+> to increase or decrease the value.
- Press <BACK> to return to the **Vent Fan** set point screen.
- Press <EXIT> to return to the **AUX Mode** screen.

To Exit:

- Press <EXIT> once to return to the main menu.
- Press <EXIT> twice to return to the status screen.

Figure 20 Setting the Vent Fan Aux Mode

PV Trigger (AUX Mode)

This mode is intended to operate an alarm, or relay that disconnects the PV array, when PV input exceeds the threshold voltage set by the user. The mode turns off the alarm or PV disconnect after the PV voltage decreases below the threshold for a time period that is set by the user.



CAUTION: Hazard to Equipment

Do not exceed 150 Vdc or the FLEXmax could be damaged.

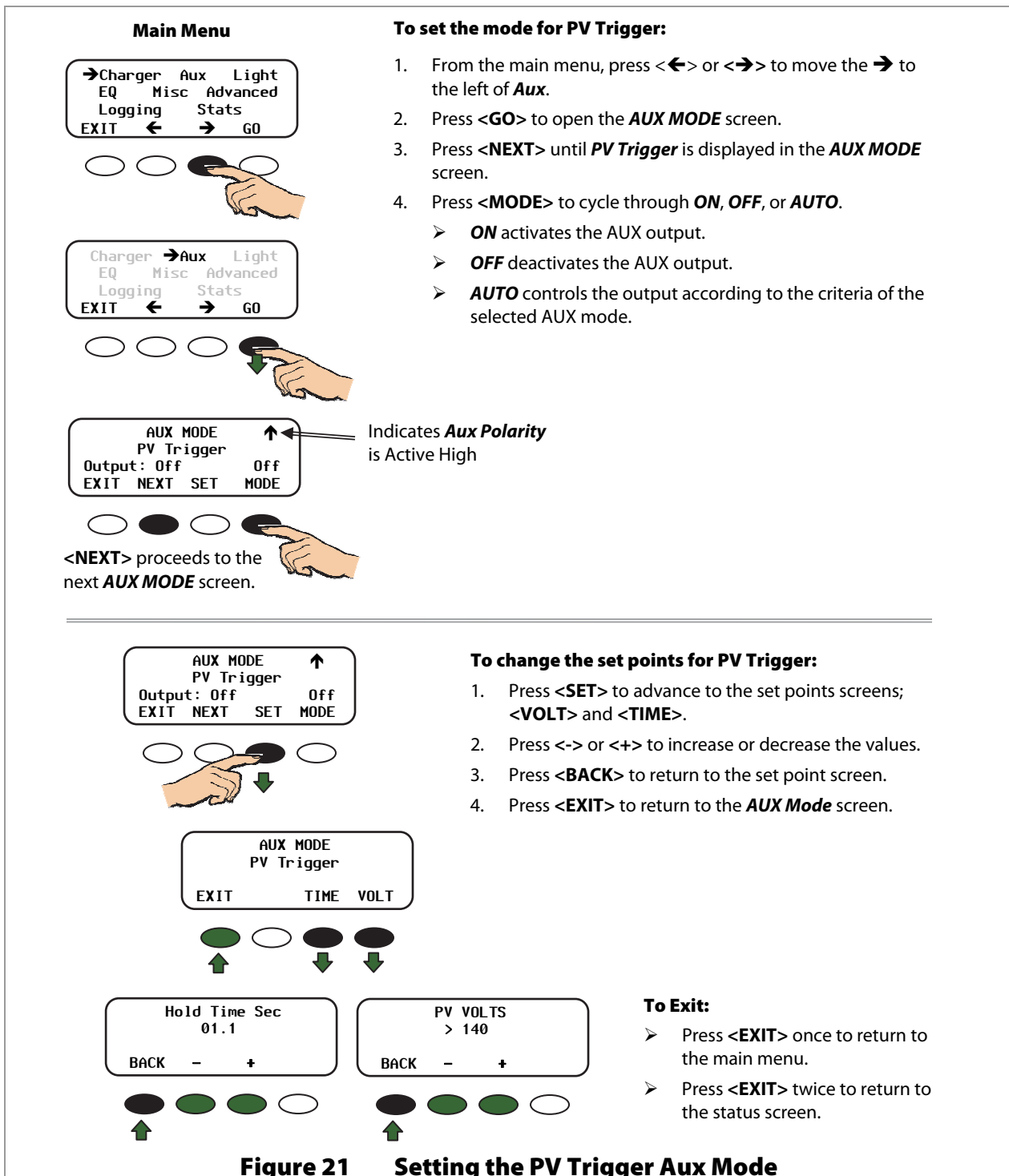

Figure 21 Setting the PV Trigger Aux Mode

Error Output (AUX Mode)

This mode is useful for monitoring remote sites. It is intended to signal when the charge controller has not charged the batteries for 26 hours or more or if the battery voltage has fallen below the threshold voltage for more than 10 minutes. The 26-hour timer can be viewed.

When set as Active Low, it can operate an alarm by sending a signal through a modem to a computer to alert the operator of the condition.

Main Menu

→Charger Aux Light
EQ Misc Advanced
Logging Stats
EXIT ← → GO

Charger →Aux Light
EQ Misc Advanced
Logging Stats
EXIT ← → GO

AUX MODE
ERROR OUTPUT
Output: On On
EXIT NEXT SET MODE

AUX MODE
ERROR OUTPUT
Output: Off On
EXIT NEXT SET MODE

AUX MODE
ERROR OUTPUT
EXIT 01 hrs VOLT

ERROR LOW BATT VOLTS
< 11.5
BACK - +

To set the mode for Error Output:

1. From the main menu, press <←> or <→> to move the → to the left of the **Aux** function.
2. Press <GO> to open the **AUX MODE** screen.
3. Press <NEXT> until **ERROR OUTPUT** is displayed in the **AUX MODE** screen.
4. Press <MODE> to cycle through **ON**, **OFF**, or **AUTO**.
 - **ON** activates the AUX output.
 - **OFF** deactivates the AUX output.
 - **AUTO** controls the output according to the criteria of the selected AUX mode.

NOTE: To advance to the timer screen, press <SET>. This timer counts up to the 26-hour limit before the AUX output is activated.

The voltage set point for this mode can also be changed.

To change the set point for ERROR OUTPUT:

1. Advance to the timer screen as noted above.
2. Press <VOLT> to advance to the **ERROR LOW BATT VOLTS** screen.
3. Press <-> or <+> to increase or decrease the value.
4. Press <BACK> to return to the **ERROR OUTPUT** set point screen.
5. Press <EXIT> to return to the **AUX Mode** screen.

To Exit:

- Press <EXIT> once to return to the main menu.
- Press <EXIT> twice to return to the status screen.

Figure 22 Setting the Error Output Aux Mode

Night Light (AUX Mode)

This mode is intended to operate a user-provided, low wattage light for as long as the charge controller remains in Sleep mode or for the ON time set by the user. **OFF** is the default value.

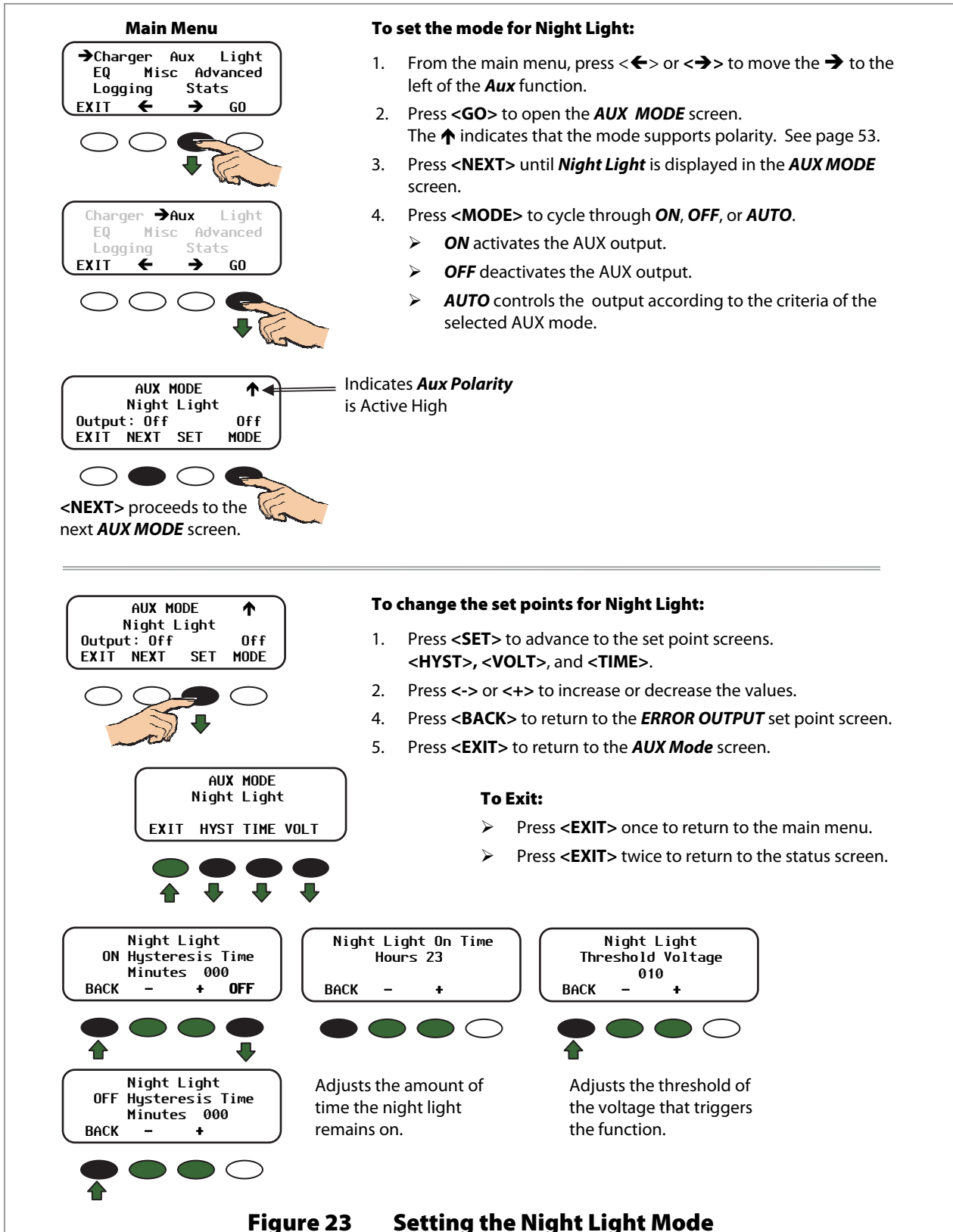

Figure 23 Setting the Night Light Mode

Float (AUX Mode)

This mode is intended to operate a load when the FLEXmax is in the Float stage of charging the batteries.

Main Menu

→Charger	Aux	Light
EQ	Misc	Advanced
Logging		Stats
EXIT ←		→ GO

○ ○ ● ○

AUX MODE

Charger	→Aux	Light
EQ	Misc	Advanced
Logging		Stats
EXIT ←		→ GO

○ ○ ○ ●

AUX MODE

AUX MODE	↑
Float	
Output: Off	Off
EXIT NEXT SET	MODE

○ ● ○ ●

↓

<NEXT> proceeds to the next **AUX MODE** screen.

To set the mode for Float:

1. From the main menu, press <←> or <→> to move the → to the left of **Aux**.
2. Press <GO> to open the **AUX MODE** screen.
3. Press <NEXT> until **Float** is displayed in the **AUX MODE** screen.
4. Press <MODE> to cycle through the mode set points **ON**, **OFF**, or **AUTO**.
 - **ON** activates the AUX output.
 - **OFF** deactivates the AUX output.
 - **AUTO** controls the output according to the criteria of the selected AUX mode.

To Exit:

- Press <EXIT> once to return to the main menu.
- Press <EXIT> twice to return to the status screen.

Figure 24 Setting the Float Mode

Diversion (AUX Mode)

When external DC sources (wind, hydroelectric) are directly connected to a battery bank, any excess power should be sent to a diversion load, such as a heating element, using a mechanical relay or solid-state relay.

In Diversion mode, the user programs set points — from -5.0 volts to 5.0 volts relative to the Absorbing, Float, and EQ voltages — to activate the AUX output. The Diversion AUX mode can be active (ON) when the battery voltage is raised above one of these set points for a certain amount of time or inactive (OFF) when it falls below.

- To control a mechanical relay for basic on/off switching of a standard diversion load, follow the instructions in Figure 25 (both pages).
- To control a solid-state relay for PWM switching and precise control of a load, follow the instructions in Figure 26 (both pages). This application should not be used with a mechanical relay. It requires the use of a resistive load and should not be used with other sorts of loads.

For a wiring diagram illustrating how to connect this function, see Figure 27.

Diversion:Relay Mode

Main Menu

→Charger Aux Light
EQ Misc Advanced
Logging Stats
EXIT ← → GO

Charger →Aux Light
EQ Misc Advanced
Logging Stats
EXIT ← → GO

AUX MODE ↑
Diversion:Relay
Output: Off Off
EXIT NEXT SET MODE

<NEXT> proceeds to the next **AUX MODE** screen.

IMPORTANT:

If using wind or hydroelectric turbines, keep the charge controller's diversion voltage slightly above the Absorbing and Float voltage settings for efficient functioning.

To set the mode for Diversion:Relay:

1. From the main menu, press <←> or <→> to move the → to the left of **Aux**.
2. Press <GO> to open the **AUX MODE** screen.
3. Press <NEXT> until **Diversion:Relay** is displayed in the **AUX MODE** screen.
4. Press <MODE> to cycle through the mode set points **ON**, **OFF**, or **AUTO**.
 - **ON** activates the AUX output.
 - **OFF** deactivates the AUX output.
 - **AUTO** controls the output according to the criteria of the selected AUX mode.

Continued on next page....

Figure 25 Setting the Diversion:Relay AUX Mode (Part 1)

...continued from previous page.

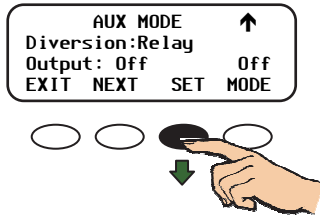

To change the set points for Diversiion:Relay:

1. Press <SET> to advance to the set point screens;
2. Press <TIME> to advance to the *Time* screen. This allows the user to adjust the minimum time the AUX output is active after the battery voltage falls below the hysteresis voltage.
3. Press <-> or <+> to increase or decrease the *Hold* time values.
4. Press <DLY+> to increase the *Delay Time*.
5. Press <BACK> to return to the *Diversiion:Relay TIME* and *VOLT* screen.
6. Press <VOLT> to move into the *Relative Volts* screen.
7. Press <-> or <+> to increase or decrease the values.
8. Press <HYST> to select the hysteresis value.
9. Press <BACK> to return to the main *Diversiion:Relay TIME* and *VOLT* screen.
10. From the *Diversiion:Relay* screen, press <EXIT> to return to the *AUX MODE* screen.

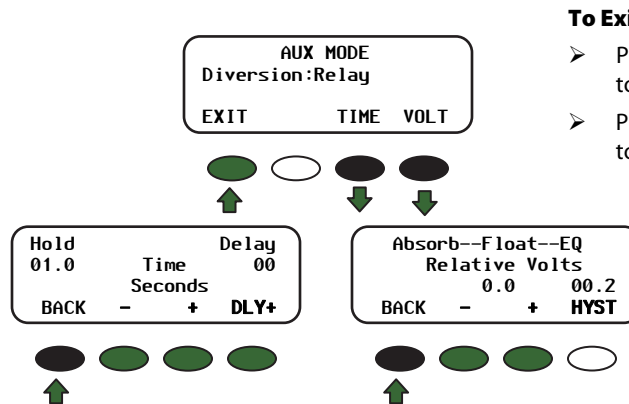

To Exit:

- Press <EXIT> once to return to the main menu.
- Press <EXIT> twice to return to the status screen.

Hold time shows how long the AUX output stays active after the battery voltage has fallen below the **HYST** (hysteresis) set point. The user can adjust the **Hold** time from 0.1 to 25 seconds.

The **Delay** time shows how long the battery voltage must be above the **Relative Volts** before the AUX mode is activated. It can be adjusted from 0 to 24 seconds, *but is rarely required*.

Pressing the <BACK> soft key returns to the **AUX MODE Diversiion: Relay TIME** and **VOLT** screen.

Use this screen to establish the set points for starting and ending the AUX mode relative to the Absorb, Float, and EQ voltages.

The <HYST> (hysteresis) set point establishes when the AUX mode becomes inactive after the battery voltage falls below the **Relative Volts** voltage minus the hysteresis value.

Figure 25 Setting the Diversiion:Relay Mode (Part 2)

Diversion:Solid St (AUX Mode)

Main Menu

→Charger Aux Light
 EQ Misc Advanced
 Logging Stats
 EXIT ← → GO



Charger →Aux Light
 EQ Misc Advanced
 Logging Stats
 EXIT ← → GO



AUX MODE ↑
 Diversion:Solid St
 Output: Off Off
 EXIT NEXT SET MODE



<NEXT> proceeds to the next **AUX MODE** screen.



IMPORTANT:

- If using wind or hydroelectric turbines, keep the charge controller's diversion voltage slightly above its Absorb and Float voltage settings for efficient functioning.
- Do not use **Diversion:Solid St** with a mechanical relay. The PWM action could cause irregular relay activity.
- **Diversion:Solid St** requires the use of a purely resistive load. The PWM action may work poorly with mechanical loads.

To set the mode for Diversion:Solid St:

1. From the main menu, press <←> or <→> to move the → to the left of **Aux**.
2. Press <GO> to open the **AUX MODE** screen.
3. Press <NEXT> until the **Diversion:Solid St** mode is displayed in the **AUX MODE** screen.
4. Press <MODE> to cycle through **ON**, **OFF**, or **AUTO**.
 - **ON** activates the AUX output.
 - **OFF** deactivates the AUX output.
 - **AUTO** controls the output according to the criteria of the selected AUX mode.

Continued on next page...

Figure 26 Setting the Diversion:Solid St AUX Mode (Part 1)

Continued from previous page...

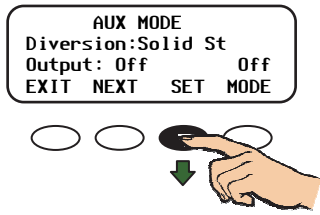

To change the set points for Diversion:Solid St:

1. Press <SET> to advance to the set point screens;
<VOLT> and <TIME>.
2. Press <TIME> to advance to the **Time** screen. This allows the user to adjust the minimum time the AUX output is active after the battery voltage falls below the hysteresis voltage.
3. Press <-> or <+> to increase or decrease the **Hold** time values.
4. Press <DLY+> to increase the **Delay** time.
5. Press <BACK> to return to the **Diversion:Solid St TIME** and **VOLT** screen.
6. Press <VOLT> to move into the **Relative Volts** screen.
7. Press <-> or <+> to increase or decrease the values.
8. Press <HYST> to select the hysteresis value.
9. Press <BACK> to return to the **Diversion:Solid St Time** and **Volt** screen.
10. From the **Diversion:Solid St** screen, press <EXIT> to return to the **AUX MODE** screen.

To Exit:

- Press <EXIT> once to return to the main menu.
- Press <EXIT> twice to return to the status screen.

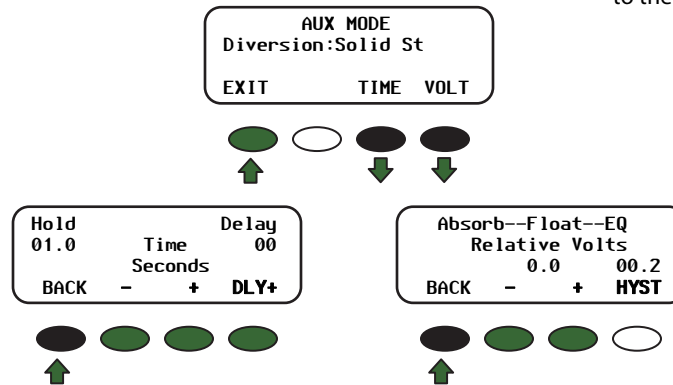

Hold time shows how long the AUX mode stays active after the battery voltage has fallen below the **HYST** (Hysteresis) set point. The user can adjust the **Hold** time from 0.1 to 25 seconds.

The **Delay Time** shows how long the battery voltage must be above the **Relative Volts** before the AUX mode is activated. It can be adjusted from 0 to 24 seconds, *but is rarely required.*

Use this screen to establish the set points for starting and ending the AUX mode relative to the Absorb, Float, and EQ voltages.

The <HYST> (hysteresis) set point establishes when the AUX mode becomes inactive after the battery voltage falls below the **Relative Volts** voltage minus the **HYST** value.

Figure 26 Setting the Diversion:Solid St Mode (Part 2)

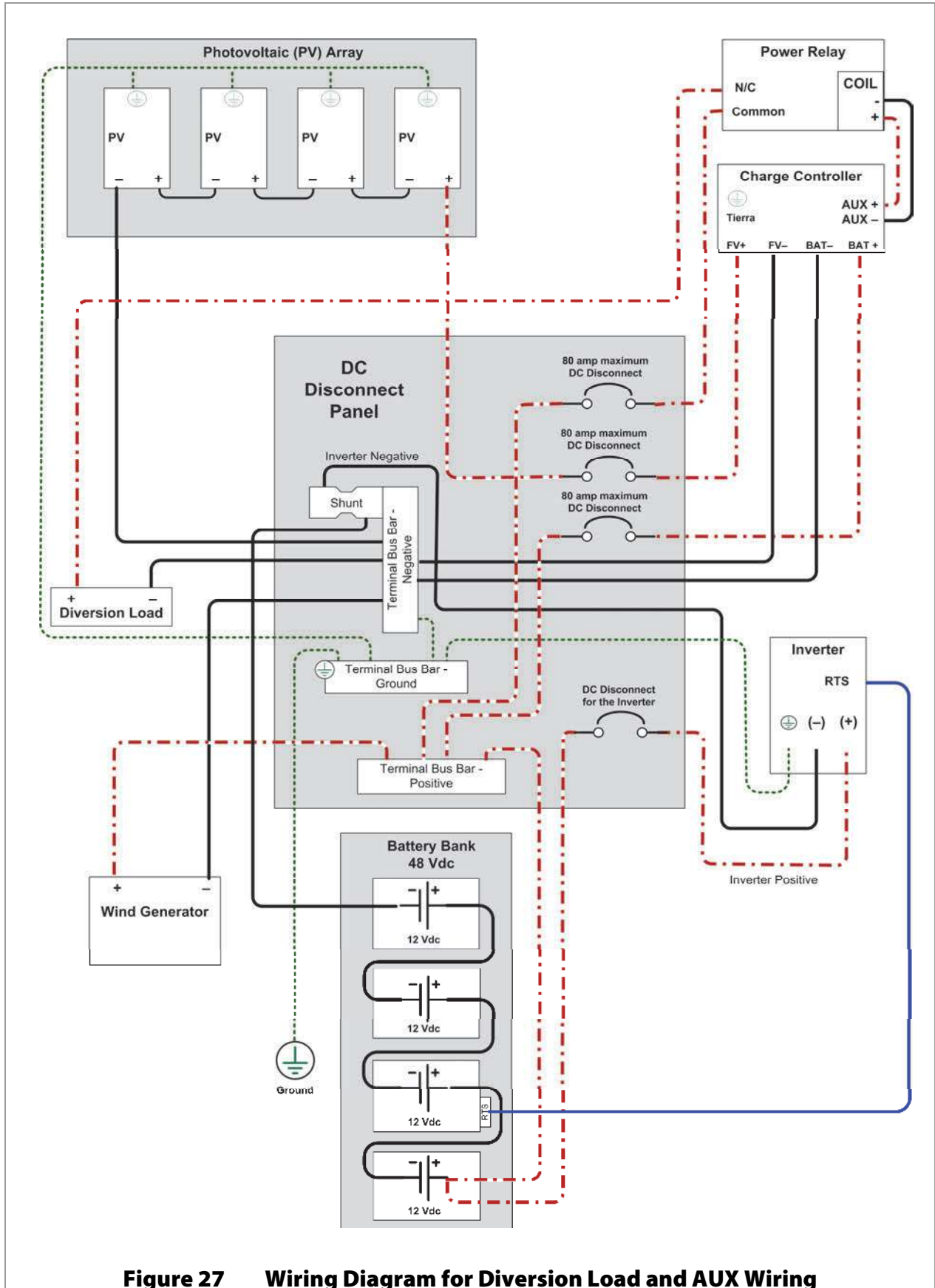

Figure 27 Wiring Diagram for Diversion Load and AUX Wiring

Low Battery Disconnect (AUX Mode)

This mode disconnects “auxiliary” loads from the batteries in the event of low voltage. These are separate from the usual loads. Auxiliary loads are controlled by the AUX output, usually by a larger relay. When the battery voltage falls below the **DISCONNECT VOLTS** setting, the AUX loads are disconnected. When the voltage rises above the **RE-CONNECT VOLTS**, they will be reconnected.

Any loads not controlled this way, such as an inverter, may continue discharging the battery.

Main Menu

→Charger Aux Light
EQ Misc Advanced
Logging Stats
EXIT ← → GO

AUX MODE

Low Batt Disconnect
Output: Off Off
EXIT NEXT SET MODE

AUX MODE

Low Batt Disconnect
EXIT TIME VOLT

Delay Time Sec
01 Timer
BACK - +

To set the mode for Low Battery Disconnect in Aux mode:

- From the main menu, press <←> or <→> to move the → to the left of the **Aux**.
- Press <GO> to open the **AUX MODE** screen.
- Press <NEXT> until the **Low Batt Disconnect** Mode is displayed in the **AUX MODE** screen.
- Press <MODE> to cycle through the mode set points; **ON**, **OFF**, or **AUTO**.
 - **ON** activates the AUX output.
 - **OFF** deactivates the AUX output.
 - **AUTO** controls the output according to the criteria of the selected AUX mode.

To change the set points for Low Battery Disconnect:

- Press <SET> to advance to the set point screens; <VOLT> and <TIME>.
- Press <TIME> to advance to the **Delay Time Sec** screen.
- Press <-> or <+> to increase or decrease the values.
- Press <BACK> to return to the main **Low Batt Disconnect** screen.
- Press <VOLT> to advance to the **DISCONNECT VOLTS** screen.
- Press <-> or <+> to increase or decrease the values.
- Press <RECON> to advance to the **RE-CONNECT VOLTS** screen.
- Press <-> or <+> to increase or decrease the values.
- Press <DisV> to return to the **DISCONNECT VOLTS** screen.
- Press <BACK> to return to the **Low Batt Disconnect** screen.

To Exit:

- Press <EXIT> once to return to the main menu.
- Press <EXIT> twice to return to the status screen.

This is the time period the FLEXmax waits before either activating or deactivating the **AUX** mode when either the disconnect or reconnect voltages are reached.

When the low voltage occurs, the timer shows the seconds remaining before disconnecting.

Figure 28 Low Battery Disconnect Mode

Remote (AUX Mode)

Remote allows an OutBack system display to control the charge controller's auxiliary output. Some displays may require a certain level of software in order to use this feature. Consult the owner's manual for the system display being used for details.

Main Menu

Charger Aux →Light
EQ Misc Advanced
Logging Stats
EXIT ← → GO

Charger →Aux Light
EQ Misc Advanced
Logging Stats
EXIT ← → GO

AUX MODE
Remote
Output: Off Off
EXIT NEXT SET MODE

To set the mode for Remote:

- From the main menu, press <←> or <→> to move the → to the left of the **Aux**.
- Press <GO> to open the **AUX MODE** screen.
- Press <NEXT> until the **Remote** mode is displayed in the **AUX MODE** screen.
- Press <MODE> to cycle through **ON**, **OFF**, or **AUTO**.
 - **ON** activates the AUX output.
 - **OFF** deactivates the AUX output.
 - **AUTO** controls the output according to the criteria of the selected AUX mode. This setting may be required depending on the type of system display being used.

To Exit:

- Press <EXIT> once to return to the main menu.
- Press <EXIT> twice to return to the status screen.

The FLEXmax AUX output can be used for the AGS (Advanced Generator Start) function of a system display. **Remote** must be activated for this to work. The system display must be set to the HUB port used by the FLEXmax. See the system display manual for more information on AGS. If using a MATE, see page 81 of this book. If using a MATE3, see page 67.

Figure 29 Setting the Remote Mode

Backlight

The **Backlight** selection allows the LCD and soft keys to remain illuminated for up to nine minutes whenever any soft key is pressed. The default setting for this mode is **AUTO**. Pressing any soft key when the LCD is not illuminated does not change any settings.

Main Menu

→Charger Aux Light
EQ Misc Advanced
Logging Stats
EXIT ← → GO

Charger Aux →Light
EQ Misc Advanced
Logging Stats
EXIT ← → GO

BACKLIGHT CONTROL
Auto Time 2 Minutes
EXIT - + AUTO
MODE

To set the mode for Backlight:

- From the main menu, press <←> or <→> to move the → to the left of **Light**.
- Press <GO> to open the **Backlight Control** screen.
- Press <MODE> to cycle through **ON**, **OFF**, or **AUTO**.
 - **ON** activates the backlight.
 - **OFF** deactivates the backlight.
 - **AUTO** activates the backlight on a timer.
- Press <-> or <+> to increase or decrease the number of minutes (up to 9) for the **Auto Time** mode.
- Press <EXIT> twice to return to the status screen.

To Exit:

- Press <EXIT> once to return to the main menu.
- Press <EXIT> twice to return to the status screen.

Figure 30 Operating the Backlight

EQ – Battery Equalize

Equalization is a controlled overcharge that is part of regular battery maintenance. Equalization brings the batteries to a much higher voltage than usual and “simmers” them for a period of time. This has the result of removing inert compounds from the battery plates and reducing stratification in the electrolyte. Equalization follows the same pattern as standard three-stage charging. However, instead of the Absorption voltage set points, it is controlled by the **Battery Equalize Volts** settings. The time is controlled by the **Battery Equalize Time** setting.

Equalization is normally performed only on flooded lead-acid batteries. The schedule for equalization varies with battery use and type, but it is usually performed every few months. If performed correctly, this process can extend battery life by a considerable amount.



CAUTION: Battery Damage

- Do not equalize any sealed battery types (VRLA, AGM, Gel, or other) unless approved by the manufacturer. Some batteries may suffer severe damage from equalization.
- Contact the battery manufacturer for recommendations on equalization voltage, duration, schedule, and/or advisability. Always follow manufacturer recommendations for equalization.

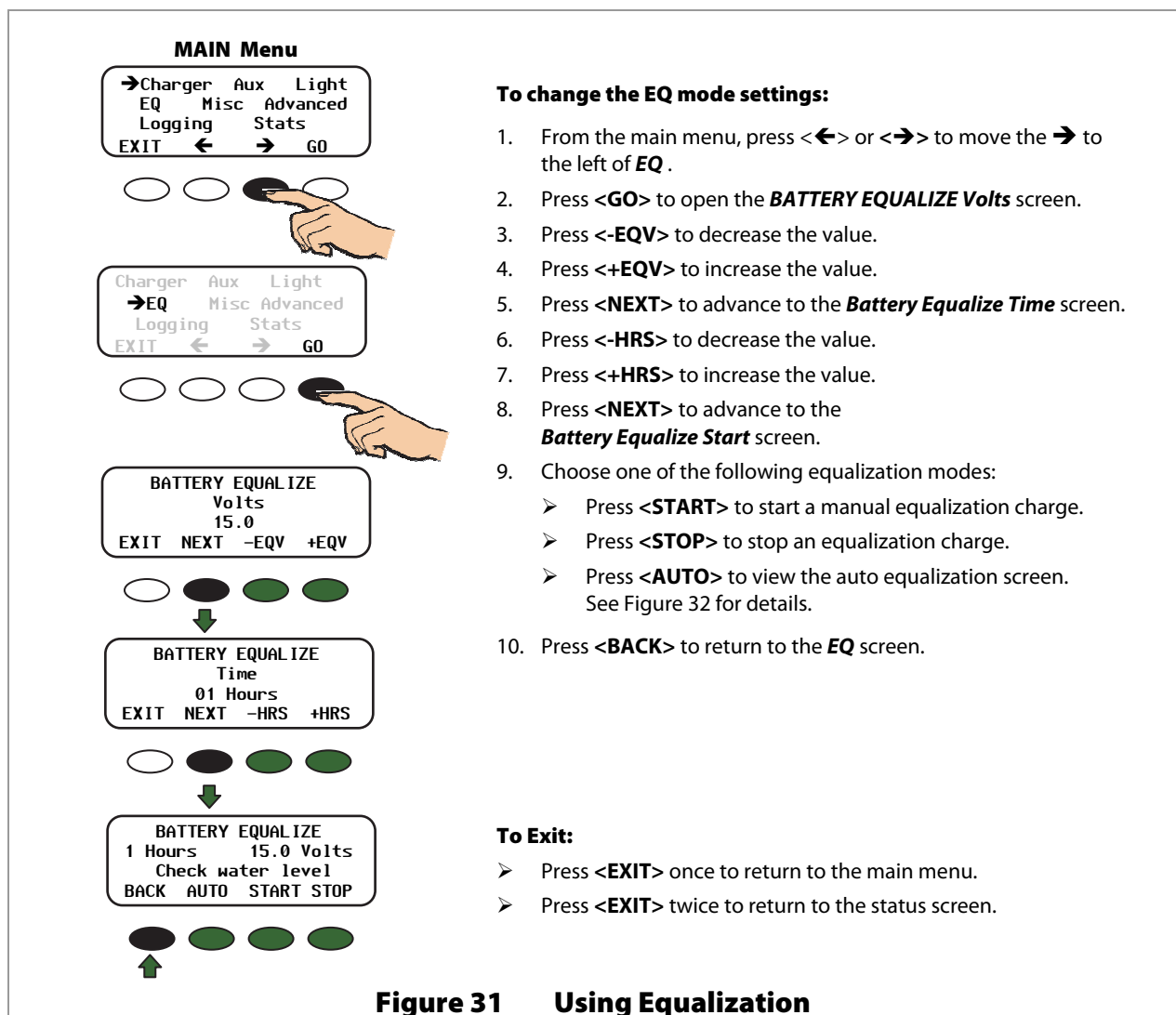
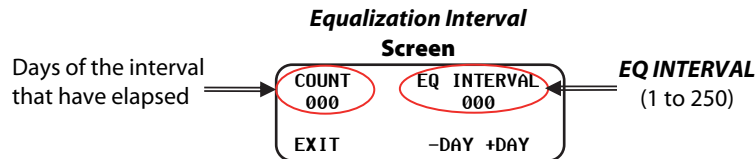

Figure 31 Using Equalization

Automatic Equalization Mode

To enable an automatic equalization mode, an interval must be set for the number of days to pass between equalization cycles. This interval can be between 1 to 250 days. The default equalization interval setting is 000 which disables this feature.

The Equalization Interval screen allows the user to set the interval between equalization cycles. It also displays how many days of the interval has passed. The **COUNT** value will be cleared to 000 when an equalization cycle is started, manually stopped, or if the charge controller has been powered off.



BATTERY EQUALIZE START Screen

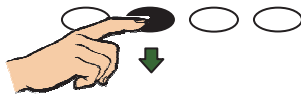
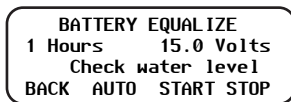

Equalization Interval Screen

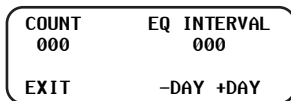

Status Screen

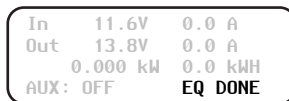
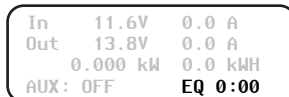
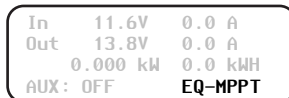

To enable an automatic EQ cycle:

1. Press **<AUTO>** to display the equalization interval screen.
2. Use **<-DAY>** or **<+DAY>** to set the number of days between each equalization cycle.
3. Press **<BACK>** to return to the status screen.

To Exit:

- Press **<EXIT>** once to return to the **EQ** screen.

On the Status Screen:

- **EQ-MPPT** will display to indicate the FLEXmax is trying to reach the target equalize set point.
- **EQ 0:00** in Hours:Minutes will display after the equalize set point is reached.
- After recharging, an **EQ DONE** message displays and a Float cycle begins. **EQ DONE** is displayed until (1) any soft key is pressed, or (2) a new day occurs for systems using an OutBack system display.

The incomplete equalization cycle continues into the next day unless the FLEXmax is powered off or manually stopped. The remaining EQ time can be viewed in the **End-of-day Summary** screen (see page 18).

Figure 32 Setting the EQ AUTO Interval

Misc Screen

There are three *Misc* screens that provide technical information about the operating state of the system. These are read-only screens and allow for no changes to any of the settings. They do provide the means to wake up the charge controller if it is in Snooze mode. They also provide a means to force the charger into a Bulk or Float stage.

Main Menu

→Charger	Aux	Light
EQ	Misc	Advanced
Logging		Stats
EXIT ←		→ GO

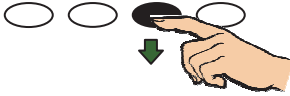

Charger	Aux	Light
EQ	→Misc	Advanced
Logging		Stats
EXIT ←		→ GO



To access the *Misc* screens:

- From the main menu, press <←> or <→> to move the → to the left of the *Misc* function.
- Press <GO> to open the *Misc* screen.

Misc Screen #1

GT	STATE	PWM%	ChgT
255	07	50.0	005
EXIT	NEXT		RSTRT



Press <EXIT> to return to the main menu.

GT	STATE	PWM%	ChgT
255	07	50.0	005
EXIT	NEXT		RSTRT

A number below **GT** means the FLEXmax is in grid-tie mode and communicating with an OutBack grid-interactive inverter. These numbers are for engineering purposes and are not significant in normal use. If the inverter is not grid-interactive, then this number will read 000. (See pages 48 and 102.)

GT	STATE	PWM%	ChgT
255	07	50.0	005
EXIT	NEXT		RSTRT

Each MPPT operation has a state which is indicated by a number. These numbers are for engineering purposes and are not significant in normal use.

GT	STATE	PWM%	ChgT
255	07	50.0	005
EXIT	NEXT		RSTRT

This indicates the percentage of "on" time for the FETs as they are performing pulse width modulation.

GT	STATE	PWM%	ChgT
255	07	50.0	005
EXIT	NEXT		RSTRT

The charge timer (**ChgT**) counts up to the Absorb time limit when the charger is in the Absorb stage. See pages 20 and 49.

Misc Screen #1

GT	STATE	PWM%	ChgT
255	07	50.0	005
EXIT	NEXT		RSTRT

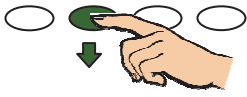

Press <NEXT> to continue to the **Force Bulk/Float** screen.

Figure 33 Miscellaneous Screen #1

Misc Screen #1

GT	STATE	PWM%	ChgT
255	07	50.0	005
EXIT	NEXT		RSTRT



To bring the charge controller out of Snoozing mode:

1. Press <RSTRT>.
2. Press <EXIT> to return to the main menu.

Misc Screen #1

GT	STATE	PWM%	ChgT
255	07	50.0	005
EXIT	NEXT		RSTRT

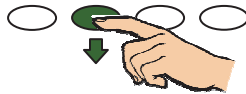

To force the charger into a Bulk or Float charge cycle:

1. Press <NEXT>.
2. Select either a Float or Bulk charge cycle. Forcing a Float or Bulk recharge will end an EQ cycle. See page 20 for details on these modes.
 - > Press <FLOAT> to force a Float charge.
 - > Press <BULK> to force a Bulk charge.
3. Press <EXIT> to return to the main menu, or press <NEXT> to view the next miscellaneous screen.

Force Bulk/Float Screen

FORCE			
EXIT	NEXT	FLOAT	BULK



Misc Screen #2

PCB	Target	BTMP	CFB
512	14.4v	255	0712
EXIT	BACK		



- > Press <BACK> to return to the **Force Bulk/Float** screen.
- > Press <EXIT> twice to return to the main menu.

PCB	Target	BTMP	CFB
512	14.4v	255	0712
EXIT	BACK		

PCB represents the temperature of the internal components. It is used to control the cooling fan. These values are in digital counts, not degrees. The lower the number, the higher the temperature. (25°C is approximately a value of 525.)

PCB	Target	BTMP	CFB
512	14.4v	255	0712
EXIT	BACK		

The target voltage the controller is trying to reach. This will depend on the active stage of the charger and the set target value for that stage.

PCB	Target	BTMP	CFB
512	14.4v	255	0712
EXIT	BACK		

BTMP is a battery temperature sensor reference value, used to compensate the charging voltage. The range is 0 to 255. These values are in digital counts, not degrees.

An **X** next to this value indicates an external RTS is being used in a system with a HUB and system display.

PCB	Target	BTMP	CFB
512	14.4v	255	0712
EXIT	BACK		

CFB represents Current FeedBack. This is the output value of the internal current sensor and is used to calculate output amps and watts to track the maximum power point of the array.

Figure 34 Miscellaneous Screen #2

Advanced Menu

The **Advanced** menu allows fine-tuning of the FLEXmax operations including Snooze periods and Maximum Power Point limits (see page 95). The following modes are available in the **Advanced** menu. They will appear in the following order.

- **Snooze Mode**
- **Wakeup**
- **MPPT Mode**
- **Park Mpp**
- **Mpp Range Limit % Voc**
- **Absorb Time**
- **Rebulk Voltage**
- **Vbatt Calibration**
- **RTS Compensation**
- **Auto Restart**
- **Aux Polarity**
- **Reset to Defaults?**

Main Menu

→Charger Aux Light
EQ Misc Advanced
Logging Stats
EXIT ← → GO

Charger Aux Light
EQ Misc →Advanced
Logging Stats
EXIT ← → GO

To Access the Advanced Menus:

- From the main menu, press <←> or <→> to move the → to the left of **Advanced**.
- Press <GO> to open the first **Advanced** menu screen.
- Press <NEXT> to cycle through the available modes. The **Snooze Mode** screen should be the first screen to display.
- Press <EXIT> to return to the status screen.

Figure 35 Accessing the Advanced Menu

Snooze Mode (Advanced Menu)

Snoozing occurs if the charging current does not reach the user-selected cutoff current set point as shown in this screen.

Snooze Mode

ADVANCED MENU
Snooze Mode
< 0.6 amp
EXIT NEXT AMP

To adjust the set point in the Snooze Mode screen:

- Navigate to the **Snooze Mode** screen through the **ADVANCED MENU** as instructed in Figure 35.
- Press <AMP> to adjust the amp setting. Amp values increments include: **0.2, 0.4, 0.6, 0.8** and **1.0**.
- Press <NEXT> to advance to the **Wakeup Mode** screen.

To Exit:

- Press <EXIT> once to return to the main menu.
- Press <EXIT> twice to return to the status screen.

Figure 36 Snooze Mode

Wakeup Mode (Advanced Menu)

Wakeup Mode sets the open-circuit voltage (Voc) conditions that cause the charge controller to wake up during **Sleep** and **Snooze** modes. Since environmental conditions impact the open-circuit voltage of an array, the Voc can be based on the last measured Voc value.

Before changing these values, monitor the system for a week or so using the factory defaults and then gradually adjust the set points. If the set points are set too high, the charge controller might not wake up soon enough or often enough, which means a loss of power production.

To adjust the set points in *Wakeup Mode*:

1. Navigate to the **Wakeup Mode** screen through the **ADVANCED MENU** as instructed in Figure 35.
2. Press **<AMP>** to adjust the amp setting. Amp values increment include: **0.2, 0.4, 0.6, 0.8** and **1.0**.
3. Press **<NEXT>** for the voltage settings screen.
4. Press **<+VOC>** or **<-Min>** to adjust the voltage and delay settings.
 - **<+VOC>** ranges from 1.5 V up to 9.5 V
 - **<+MIN>** ranges from 5 up to 15 minutes
5. Press **<NEXT>** for the **MPPT Mode** screen.

To Exit:

- Press **<EXIT>** once to return to the main menu.
- Press **<EXIT>** twice to return to the status screen.

Figure 37 Wakeup Mode

MPPT Mode (Advanced Menu)

This screen allows the user to choose from the following modes:

- **Auto Track** MPPT mode (default) automatically tracks the PV upon wakeup and then tracks the MPP of the array. If **Auto Restart** is set to 1 or 2, the charge controller awakes every 1.5 hours and does an initial tracking. (See page 52.)
- **U-Pick %** (Voc) MPPT mode allows the user to manually adjust the MPP tracking limit as a percentage of the array's open-circuit voltage (Voc). This percentage is displayed in the **Park Mpp %** Voc screen along with the current output wattage. (See page 48.) The wattage value changes as the user adjusts the Voc percentage, letting the user lock in the most advantageous percentage value. **U-Pick %** acquires a new Voc value every 1.5 hours if **Auto Restart** is set to 1 or 2.

To select the *MPPT Mode*:

1. Navigate to the **MPPT Mode** screen through the **ADVANCED MENU** as instructed in Figure 35.
2. Press **<MODE>** to choose an MPPT mode. If the system has an OutBack grid-interactive inverter with a HUB and system display, press **<nonGT>** to change it to **<GT>**. This will place the charge controllers in GT mode to allow the inverter to sell excess power.
3. Press **<NEXT>** to view the **Park Mpp** screen.

To Exit:

- Press **<EXIT>** once to return to the main menu.
- Press **<EXIT>** twice to return to the status screen.

Figure 38 MPPT Mode – Auto Track

Operation

- **GT** allows the FLEXmax to work more effectively with a grid-interactive OutBack inverter. This setting automatically raises the charge controller's Float voltage to equal its Absorption voltage. Since the inverter sells power to maintain its own Float, Absorption, or Sell settings (all of which should be lower than those of the controller), this mode makes it easier for the inverter to sell power. (See pages 44 and 102 for more information on this mode.)
- **NOTE:** The charge controller's Float voltage returns to normal any time the inverter enters **PassThru** or **Silent** modes. (See the inverter *Operator's Manual* for inverter modes.)
- The **Park Mpp** screen will be slightly different between **Auto Track** mode and **U-pick** mode. In the **U-pick** mode, the **Watts** will appear in addition to the **%Voc** value.

MPPT Mode Auto Track

ADVANCED MENU
MPPT Mode
Auto Track
EXIT NEXT nonGT MODE

MPPT Mode U-pick%

ADVANCED MENU
MPPT Mode
U-pick%
EXIT NEXT nonGT MODE

Auto Track Park Mpp

ADVANCED MENU
Park Mpp
77 % Voc
EXIT NEXT -% +%

U-pick% Park Mpp

ADVANCED MENU
Park Mpp
Watts 0251 77 % Voc
EXIT NEXT -% +%

Mpp Range Limit % Voc

ADVANCED MENU
Mpp Range Limit %VOC
Min Max
EXIT NEXT 1/2 90%

Mpp Range Limit % Voc

ADVANCED MENU
Mpp Range Limit %VOC
Min Max
EXIT NEXT 1/2 90%

To adjust the Park Mpp voltage percentage settings:

1. Press **<NEXT>** to view the **Mpp Range Limit % VOC** screen.
2. Choose one of the following options:
 - Press **<-%>** to decrease the value.
 - Press **<+%>** to increase the value.
3. Press **<NEXT>** to advance to the **Mpp Range Limit %Voc** screen.
4. Press **<Min>** or **<Max>** to adjust the MPP range limit.

To Exit:

- Press **<EXIT>** once to return to the main menu.
- Press **<EXIT>** twice to return to the status screen.
- Press **<NEXT>** to advance to the **Absorb Time Limits** screen.

The **Mpp Range Limit % Voc** adjusts the upper range limit of the FLEXmax controller's maximum power point (MPP) tracking.

The default **Max** MPP voltage limit is set at 90% of the Voc and is normally not adjusted for a PV array. If necessary, the adjustable limits are 80%, 85%, 90%, and 99% of the Voc.

Min optimizes the tracking window for MPPT. The default **Min** setting of **1/2** establishes the lower limit of this window as one-half the Voc.

The **Min** range limit setting may be set to **FULL** if something other than a PV array is connected to the input of the FLEXmax, such as a hydroelectric turbine (see page 100). However, the input voltage must never exceed 150 Vdc at any time.

Figure 39 MPPT Mode – U-Pick %

Absorb Time Limits (Advanced Menu)

The amount of time the charge controller stays in the Absorbing stage of charging can be adjusted in the **Absorb Time Limits** screen. An Absorbing charge stage normally ends when the battery voltage is maintained at the Absorbing set point for the time period set in the **Absorb Time Limits** screen.

- Absorb Time is adjustable from 0 to 24 hours (consult the battery manufacturer’s recommendations).
- When the Absorb Time Limit is reached, the charge controller goes into Float stage and may briefly display **Charged**, then **Float**. When the battery voltage drops below the **Float** voltage set point, the charge controller recharges to maintain this set point, employing the MPPT function in **MPPT Float** mode.

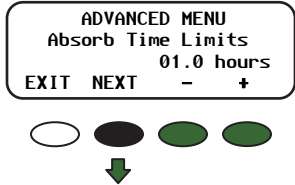

To adjust the set points in the Absorb Time Limits screen:

1. Navigate to the **Absorb Time Limits** screen through the **ADVANCED MENU** as instructed in Figure 35.
2. Use <-> or <+> to adjust the Absorb time from **0.0** to **24.0** hours following the recommendation of the battery manufacturer.
3. Press <NEXT> to advance to the **Absorb End Amps** screen.

To Exit:

- Press <EXIT> once to return to the main menu.
- Press <EXIT> twice to return to the status screen.

Figure 40 Absorb Time Limits Screen

Absorb End Amps (Advanced Menu)

While the battery voltage is at or above the Absorbing voltage target (see page 20) and the **Absorb End Amps** value is reached for a time delay of 15 seconds, the charge controller will switch to the Float stage. This happens regardless of the charger time minutes as shown in the **Misc** menu under **ChgT** (see page 44). The charger timer will be reset to zero.

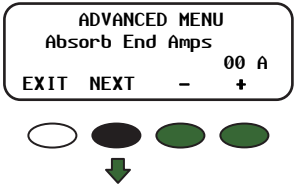

To adjust the set points in the Absorb End Amps screen:

1. Navigate to the **Absorb End Amps** screen through the **ADVANCED MENU** as instructed in Figure 35.
2. Use <-> or <+> to adjust the amperage limit following the recommendation of the battery manufacturer. The default value is 00.
3. Press <NEXT> to advance to the **Rebulk Voltage** screen.

To Exit:

- Press <EXIT> once to return to the main menu.
- Press <EXIT> twice to return to the status screen.

Figure 41 Absorb End Amps Screen

Rebulk Voltage (Advanced Menu)

In the *Float* stage, if the battery voltage falls below the **ReBulk Voltage** set point for at least 90 seconds, the FLEXmax will automatically initiate a new charge cycle.

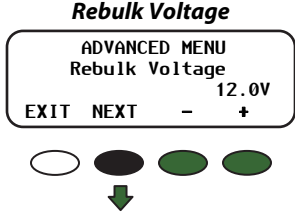

Rebulk Voltage

ADVANCED MENU
Rebulk Voltage 12.0V

EXIT NEXT - +

To adjust the set points in the *Rebulk Voltage* screen:

1. Navigate to the **Rebulk Voltage** screen through the **ADVANCED MENU** as instructed in Figure 35.
2. Use <-> or <+> to adjust the voltage limit following the recommendation of the battery manufacturer. The default values are 12.0 V, 24.0 V, 36.0 V, 48.0V and 60.0 V.
3. Press <NEXT> to advance to the **Vbatt Calibration** screen.

To Exit:

- Press <EXIT> once to return to the main menu.
- Press <EXIT> twice to return to the status screen.

Figure 42 Rebulk Voltage

Vbatt Calibration (Advanced Menu)

A quality, calibrated voltmeter will provide even more accurate FLEXmax battery readings if an undesirable voltage drop occurs. When measuring battery voltage, ensure a good connection is made to the four wire lugs. Check the battery temperature compensation voltages if the voltages are much different than expected from the charger setup **Absorbing** and **Float** voltage settings.

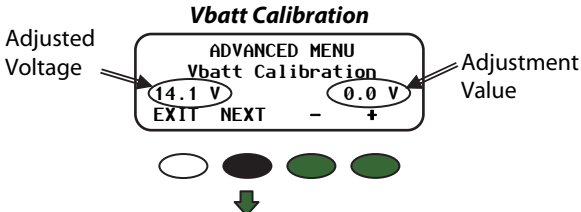

Vbatt Calibration

ADVANCED MENU
Vbatt Calibration

14.1 V 0.0 V

EXIT NEXT - +

NOTE: The adjusted voltage value should appear on the status screen.

To adjust the set points in the *Vbatt Calibration* screen:

1. Navigate to the **Vbatt Calibration** screen through the **ADVANCED MENU** as instructed in Figure 35.
2. Use <-> or <+> to increase or decrease the value. The voltage will change in increments of 0.1 Vdc.
3. Press <NEXT> to advance to the **RTS Compensation** screen.

To Exit:

- Press <EXIT> once to return to the main menu.
- Press <EXIT> twice to return to the status screen.

Figure 43 Vbatt Calibration

RTS Compensation (Advanced Menu)

The **RTS Compensation** screen allows the user to control the Absorbing and Float voltage limits during charging when using a Remote Temperature Sensor (RTS). The RTS adjusts charging voltage depending on battery temperature. (See page 97 for the amount of compensation per degree.) However, some conditions can make compensation less than optimal, such as extreme weather (hot or cold), or charging restrictions from the battery manufacturer. Therefore, the **RTS Compensation** screen allows the user to control the limits used by the compensation feature.

For example:

- During cold weather, a battery often requires a higher charging voltage. Some inverters might not accommodate these higher voltages and can shut down during charging, cutting off power to their loads.
- During hot weather, limiting the **RTS Compensation** values assures the voltage stays high enough to charge the batteries instead of dropping too low in reaction to a higher ambient temperature.
- Battery manufacturer specifications indicate not to exceed a certain voltage or battery damage could occur.

In all cases, the batteries should be monitored to ensure they are being charged according to the battery manufacturer's recommendations.

RTS Compensation has two options available.

- **WIDE** allows the RTS full control over charging. This option uses the default values for the RTS.
- **LIMIT** sets the minimum and maximum voltages for the RTS.

Pressing the soft key below each option switches between the two options. When the **LIMIT** option is visible, a **<SET>** soft key is available to advance to a screen that allows the user to adjust the settings.

RTS Compensation Screen

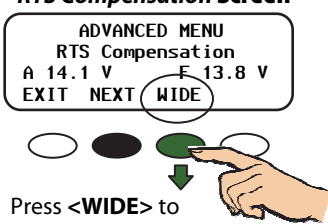

Press **<WIDE>** to switch to **LIMIT**.

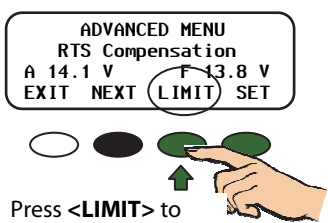

Press **<LIMIT>** to switch back to **WIDE**.

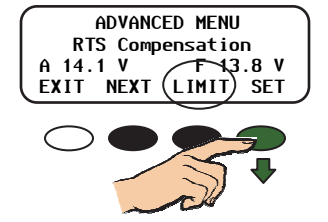

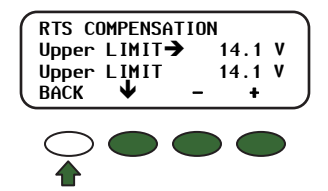

To use the default RTS compensation values:

1. Navigate to the **RTS Compensation** screen through the **ADVANCED MENU** as instructed in Figure 35.
2. If **WIDE** is visible above the soft key, the absorb and float values shown in this screen will be used by the system.

To Exit:

- Press **<NEXT>** to advance to the **Auto ReStart** menu.
- Press **<EXIT>** once to return to the main menu.
- Press **<EXIT>** twice to return to the status screen.

To limit the RTS compensation values:

1. Navigate to the **RTS Compensation** screen through the **ADVANCED MENU** as instructed in Figure 35.
2. If **WIDE** is visible above the soft key, press the **<WIDE>** soft key to change the display to show **LIMIT**.
3. Press **<SET>** to advance to the **RTS COMPENSATION** limits screen.
 - Press **<↓>** until the **→** is next to the limit to be changed. The **→** will switch between the upper and lower limit values each time it is pressed.
 - Press **<->** to decrease the value.
 - Press **<+>** to increase the value.

To Exit:

- Press **<BACK>** to return to the main **RTS Compensation** screen.
- Press **<EXIT>** once to return to the main menu.
- Press **<EXIT>** twice to return to the status screen.

Figure 44 RTS Compensation

Auto ReStart (Advanced Menu)

This setting allows the user to choose between continuous maximum power point (MPP) tracking, or occasional restarts of the sweeping process. A restart means the controller abandons the existing maximum power point value it was using and “re-sweeps”, or begins gathering new power point data. (See page 95 for more information on MPP tracking.)

Auto ReStart has three options available:

- **Mode 0** – Initial sweep only and then continuous MPP tracking. **Auto ReStart** is disabled. The FLEXmax will continuously track the maximum power point without starting over.
- **Mode 1** – Automatic re-sweep every 90 minutes if controller is in an MPPT mode (**MPPT Float**, **MPPT Bulk**, etc). This will not reset any counters, charging stages, or statistics.
- **Mode 2** – Automatic re-sweep every 90 minutes if controller is in any charging mode. This will not reset any counters, charging stages, or statistics.

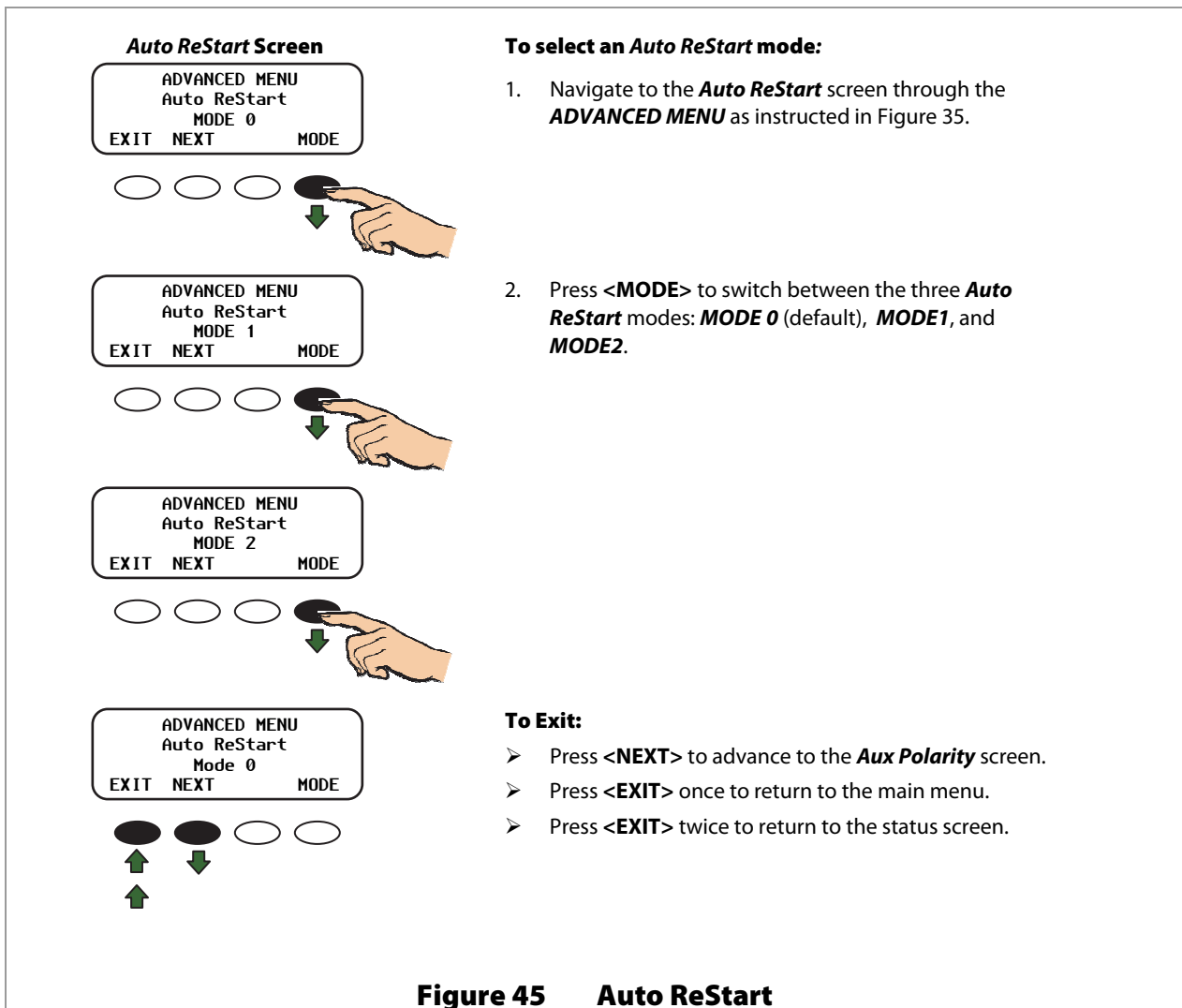

Aux Polarity (Advanced Menu)

When the AUX function is ON, 12 volts DC is present at the AUX terminals (**Active High**). When the AUX function is OFF, 0 volts DC are present at the terminals (**Active Low**).

Aux Polarity allows the user to reverse the availability of this voltage for the **Night Light**, **PV Trigger**, or **Diversion Relay** functions. When one of these functions has been chosen as the AUX function, an arrow in the right hand corner of the screen will reflect the **Aux Polarity** state.

- In **Active High**, the user establishes certain conditions for these functions.
- In the **Active Low**, zero voltage will be available for a function that in **Active High** would normally have voltage.

To select the mode for *Aux Polarity* :

1. Navigate to the **Aux Polarity** screen through the **ADVANCED MENU** as instructed in Figure 35.
2. Press <MODE> to switch between:
 ↑ **Active High** or ↓ **Active Low**

To Exit:

- Press <NEXT> to advance the **Reset to Defaults?** screen.
- Press <EXIT> once to return to the main menu.
- Press <EXIT> twice to return to the status screen.

Figure 46 Aux Polarity Screen

Reset to Defaults?

To exit the *Reset to Defaults* menu without resetting the charge controller:

- Press <EXIT> to return to the main menu.
- Press <EXIT> again to return to the status screen.

This will exit the menu without making any changes to the current settings.

To reset the FLEXmax to factory default settings:

1. Press <RESET>.
2. Press <YES> to confirm the reset. Upon the next power-up, the FLEXmax will prompt the user to confirm the voltage (see page 16).
3. Press <EXIT> twice to return to the main menu.
4. Press <NEXT> to return to the beginning of the **ADVANCED MENU** (see page 46).

This procedure is recommended any time the controller is relocated or the system is substantially revised. The settings can also be reset to the defaults by performing a reboot (see page 57).

Figure 47 Reset to Defaults? Screen

Logging

The **Logging** screen in the main menu enables the user to clear the daily and cumulative logs if necessary. Logs can be downloaded to an SD card if a MATE3 is installed. See page 69 for details.

The FLEXmax daily log begins when the controller enters **Wakeup**. See page 24.



IMPORTANT:

If two or more charge controllers are used in the same system and are started up or cleared on different days, their numeric dates will not be the same. This can lead to some misunderstandings when looking back and comparing data between the two or more units. A user looking back at day 12 on both units would find very different results.

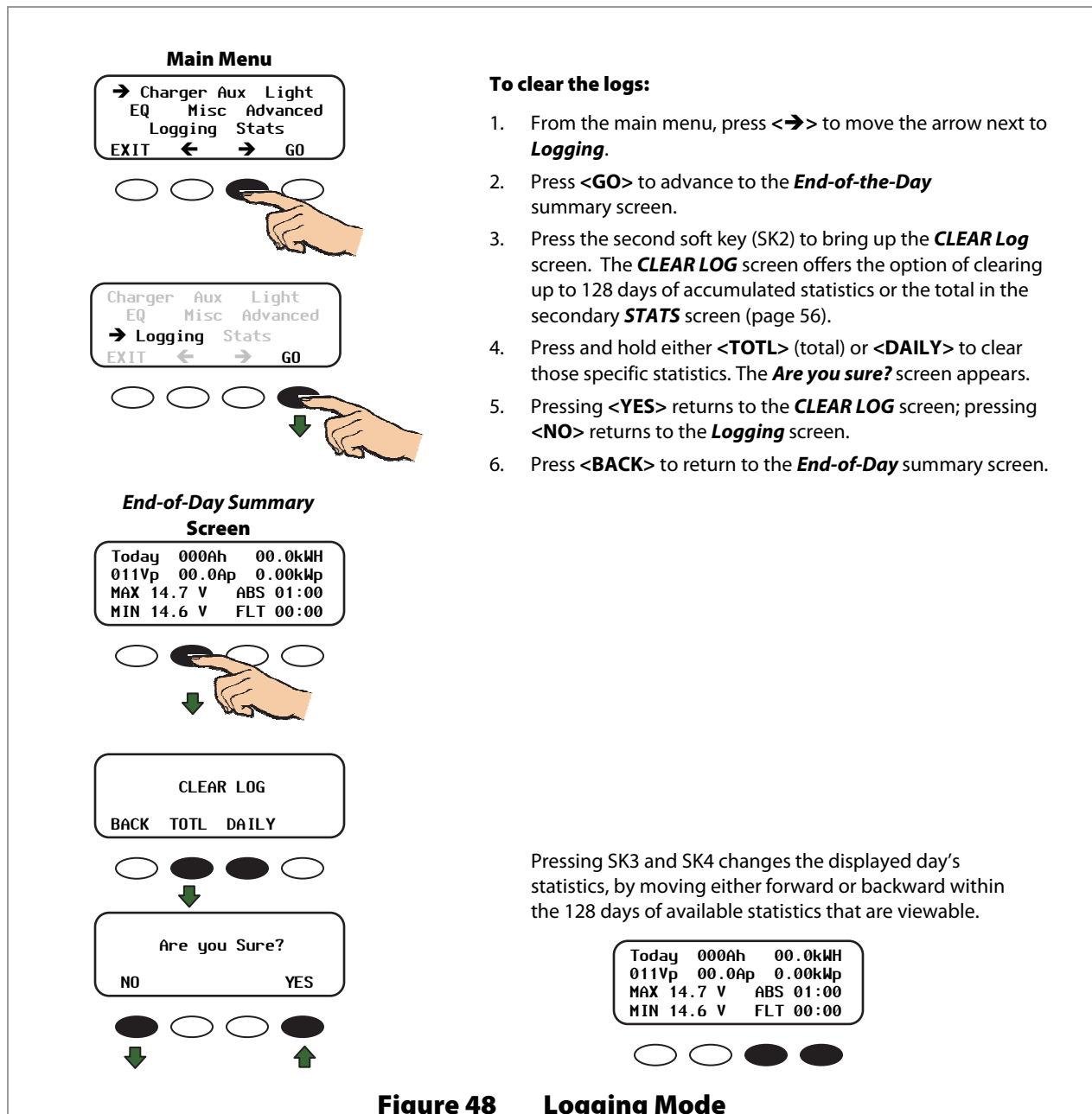

Figure 48 Logging Mode

Stats

The **STATS** screen in the main menu displays additional voltage and time information. In a stand-alone FLEXmax controller — one that is not connected to a system display — **Sunrise** shows how long ago the FLEXmax woke up for the first time each day and when the daily and total logged values were updated and cleared. If the FLEXmax is connected to a system display, the logging occurs at midnight.

Main Menu

```

→ Charger Aux Light
EQ Misc Advanced
Logging Stats
EXIT ← → GO
    
```

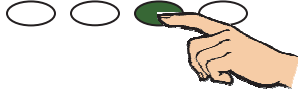

```

Charger Aux Light
EQ Misc Advanced
Logging → Stats
EXIT ← → GO
    
```

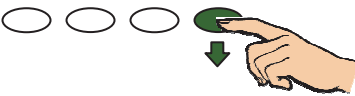

To view the STATS screen:

- From the main menu, press <→> to move the arrow next to **STATS**.
- Press <GO> to advance to the statistics screens.

<pre> Max Bat Voc MaxVoc 14.9 036.6 133.0 MaxWatt 0000 Sunrise EXIT NEXT 01:30:33 </pre>	<p>Maximum historical battery voltage occurring on the FLEXmax</p>
<pre> Max Bat Voc MaxVoc 14.9 036.6 133.0 MaxWatt 0000 Sunrise EXIT NEXT 01:30:33 </pre>	<p>Daily high Voc value</p>
<pre> Max Bat Voc MaxVoc 14.9 036.6 133.0 MaxWatt 0000 Sunrise EXIT NEXT 01:30:33 </pre>	<p>The highest historical Voc occurring on the FLEXmax.</p>
<pre> Max Bat Voc MaxVoc 14.9 036.6 133.0 MaxWatt 0000 Sunrise EXIT NEXT 01:30:33 </pre>	<p>Maximum wattage seen by the FLEXmax</p>
<pre> Max Bat Voc MaxVoc 14.9 036.6 133.0 MaxWatt 0000 Sunrise EXIT NEXT 01:30:33 </pre>	<p>The time the logs were cleared and reset</p>

```

Max Bat Voc MaxVoc
14.9 036.6 133.0
MaxWatt 0000 Sunrise
EXIT NEXT 01:30:33
    
```



Press <NEXT> to view the second **STATS** screen.

Figure 49 STATS Mode

Secondary STATS Screen

Total 00000 kWh
 Total 0000.0 kWh
 BACK DCKWH

○ ○ ○

↓

Total 00000 kWhAC
 Total 0000.0 kWh
 BACK ACKWH

○ ○

↑

The **Secondary Stats** screen shows the total accumulated DC and AC kilowatt-hours and kiloamp-hours of the charge controller.

Pressing the **<DCKWH>** soft key switches the screen between DC kilowatt-hours and AC kilowatt-hours.

- **DCKWH** shows the DC kilowatt-hours and should be used in a system that is not grid-interactive.
- **ACKWH** is used with a grid-interactive system. This measure is based on a 90% inverter efficiency (1 kWh DC= 0.9 kWh AC).

Pressing the **<BACK>** key three times returns to the main menu.

Figure 50 Secondary STATS Screen

Viewing the Firmware Revision

The current firmware revision of the FLEXmax controller can be viewed on its own screen.

Return to the main menu screen. From the status screen, press the first soft key (SK1) to open the main menu screen.

From the main menu screen, press and hold **<EXIT>** (SK1). As long as SK1 is held, it will show a **Revision** screen with the current firmware revision of the FLEXmax.

Status Screen
 In 113.6V 0.0 A
 Out 12.5V 0.0 A
 0.000 kW 0.0 kWh
 AUX: OFF Sleeping

Main Menu
 →Charger Aux Light
 EQ Misc Advanced
 Logging Stats
 EXIT ← → GO

Revision
 002.001.000

Figure 51 Firmware Revision Screen

Extended Play Mode

If the MPP voltage is low enough to approach the battery voltage (usually when the PV array is very hot), it is near the effective limit of the MPPT function. Side effects may cause the FLEXmax components to make a squealing noise. Extended Play mode alleviates this problem by extending the parameters of the MPPT sweep. (See page 98 for additional notes.)

To activate or deactivate the Extended Play feature:

Follow the instructions in Figure 51 for reaching the **Revision** screen.

While continuing to hold SK1, press and hold SK3. After a few seconds, the screen will toggle the status of Extended Play and display it. **X on** means the mode is on. If necessary, continue to press and hold SK3 until it reads **X on**.

Revision Screen
 Revision
 002.001.000

Extended Play Screen
 X on

To deactivate this function, repeat the process until the screen reads **X off**.

Figure 52 Extended Play Mode

Rebooting the FLEXmax

If the screen becomes garbled or the FLEXmax controller otherwise will not respond to commands, it may be necessary to reboot its internal processor.



IMPORTANT:

Rebooting the FLEXmax controller will return all the values and set points to the factory defaults. These values are listed on page 94. It is advisable to record all custom values before rebooting.

To reboot the FLEXmax:

1. Turn off the battery and PV array circuit breakers. The FLEXmax should have no sources of power connected. Observe the screen until it goes blank.
2. Press and hold the first and third soft keys (SK1 and SK3).
3. While holding down these soft keys, switch on the battery circuit breaker.

This process follows the power-up sequence shown on page 15. Continue to follow the **Select Version** screen instructions from the beginning of the manual.

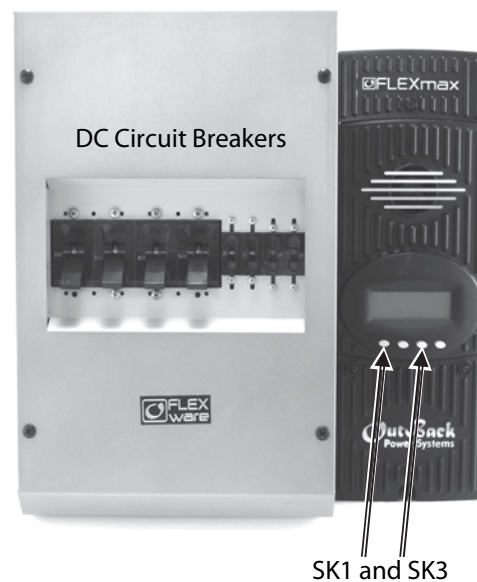

Figure 53 Rebooting the FLEXmax



MATE3 System Display and Controller

The MATE3 provides the means for programming the FLEXmax charge controller and other devices when preprogrammed default settings do not work for the destined installation.

Display and LED Status Indicators

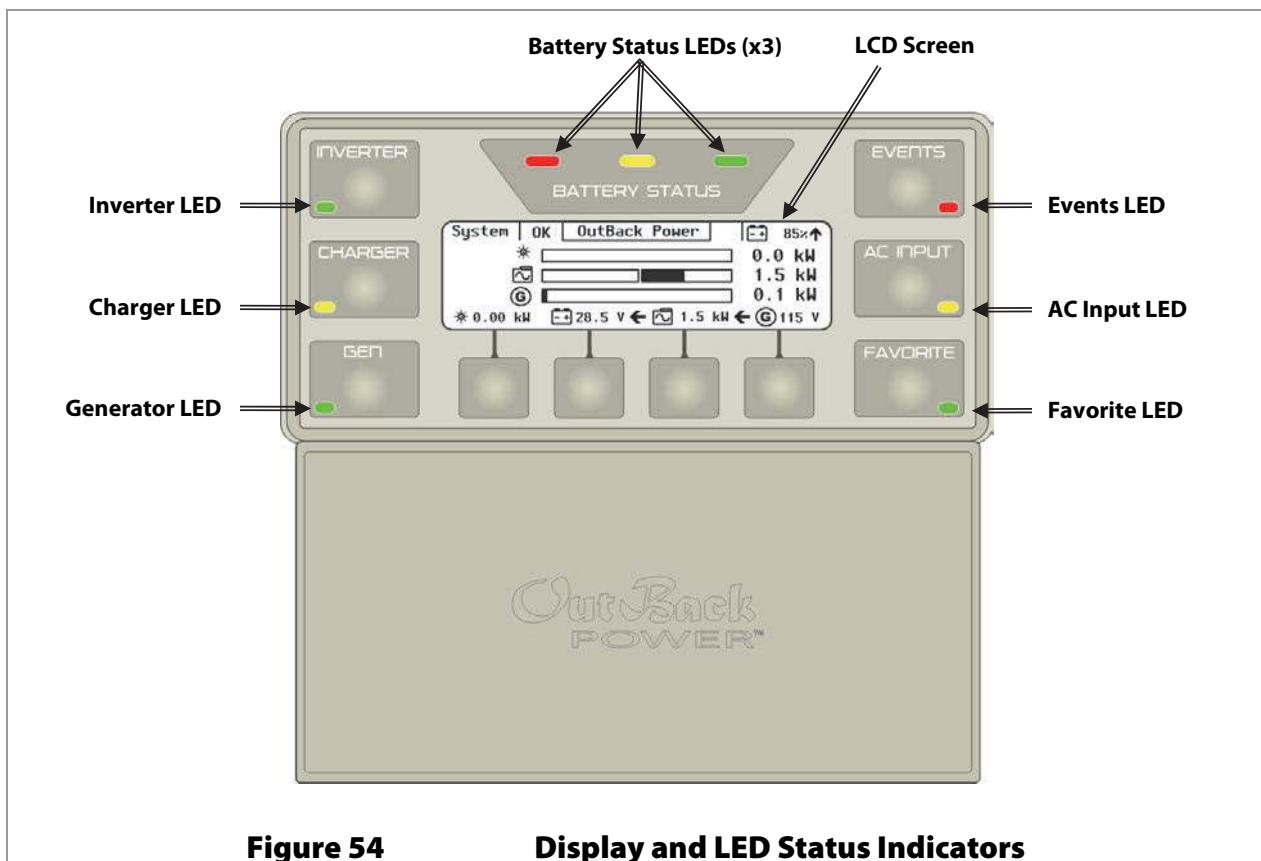

Charge Controller Soft Key

Charge Controller Soft Key

Press this soft key to view FLEXmax charge controller status information. If no charge controller is present, the PV icon will be blank and this soft key will be inoperative.

Charge Controller Modes:

- **Bulk**
- **Absorb**
- **Float**
- **EQ**
- **Silent**

The FLEXmax has over 25 modes. The MATE3 can only display five status messages and may substitute one of the five for a FLEXmax mode not on this list. Check the FLEXmax status screen to determine its exact mode.

See page 20 for a description of modes.

See page 96 for a description of battery charging.

Soft Keys:

<Datalog> brings up a group of charge controller statistics that are maintained as a continuous daily log. These screens are all shown beginning on page 61.

<Graph> brings up a series of screens that plot various charge controller information over time. The graphs include inverter and charger wattage, power imported from an AC source, battery voltage, and others. These screens are all shown beginning on page 62.

<Port> cycles through each device connected to the network. If more than one charge controller is installed in the system, pressing the **<Port>** soft key will cycle through each controller.

<Back> returns to the previous screen.

Charge Controller's Mode

Screen Items:

The upper left corner of the screen shows the FLEXmax charge controller's current mode of operation. **Bulk** is shown in this illustration.

In displays the present PV array operating voltage and the current being harvested from the array.

VOC displays the open-circuit voltage available from the PV.

Out displays the present battery voltage and the current being delivered from the charge controller(s) to charge the battery bank. To the right, this line displays the number of kilowatt-hours and amp-hours accumulated that day.

Operating displays the total hours the charger has operated that day in any stage.

Float displays the run time of the Float timer when in the Float stage.

Absorb displays the run time of the timer when in the Absorbing stage.

Maximum displays the maximum amperage and wattage harvested from the PV array that day, and the time both were recorded.

The lower right corner shows the current status of the charge controller's Auxiliary (AUX) output. (See page 66.)

Figure 55 Charge Controller Soft Key Screens

DataLog Screen

The <DataLog> soft key shows accumulated daily amp-hour and watt-hour statistics, as well as maximum current, wattage, and maximum and minimum voltage figures. These maintain a continuous daily log, up to 128 days, which can be recalled. One day can be displayed at a time. See page 55 for more information.

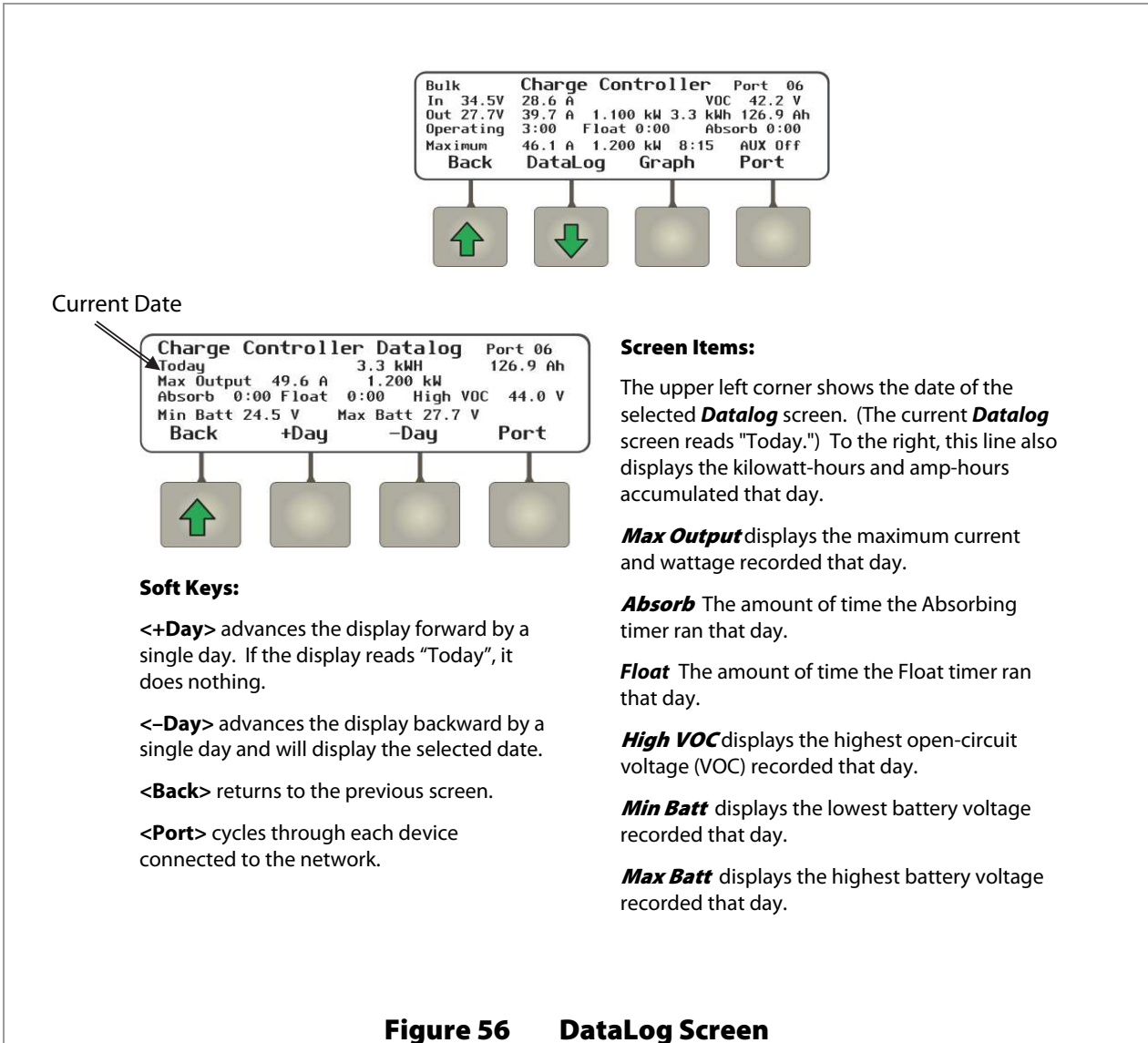

Screen Items:

The upper left corner shows the date of the selected **Datalog** screen. (The current **Datalog** screen reads "Today.") To the right, this line also displays the kilowatt-hours and amp-hours accumulated that day.

Max Output displays the maximum current and wattage recorded that day.

Absorb The amount of time the Absorbing timer ran that day.

Float The amount of time the Float timer ran that day.

High VOC displays the highest open-circuit voltage (VOC) recorded that day.

Min Batt displays the lowest battery voltage recorded that day.

Max Batt displays the highest battery voltage recorded that day.

Soft Keys:

<+Day> advances the display forward by a single day. If the display reads "Today", it does nothing.

<-Day> advances the display backward by a single day and will display the selected date.

<Back> returns to the previous screen.

<Port> cycles through each device connected to the network.

Figure 56 DataLog Screen

Graph Screens

The **<Graph>** soft key brings up the following screens which plot various type of data over time. The first screen shows changes in PV wattage over time.

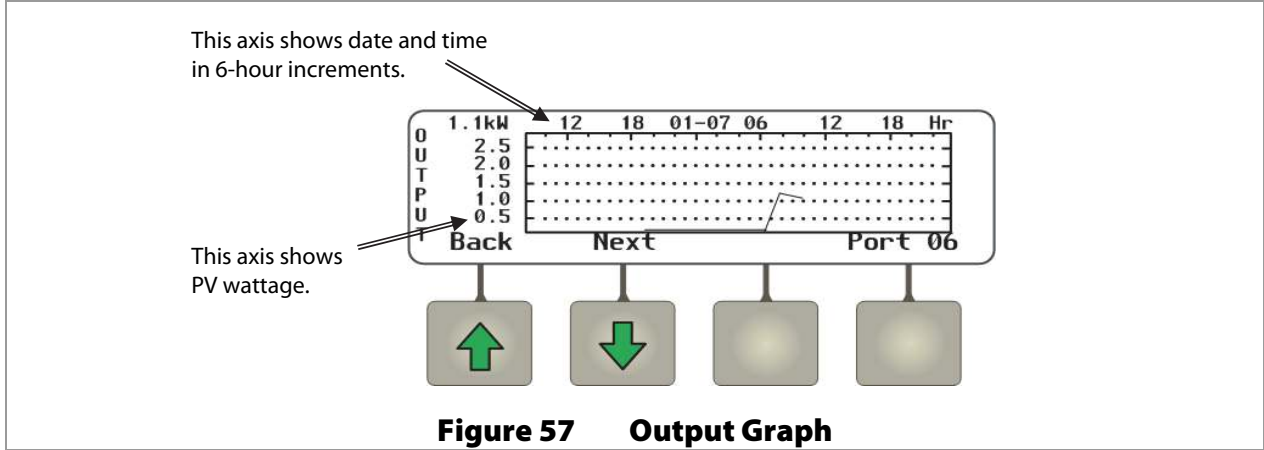

The **<Next>** soft key brings up a screen showing changes in battery voltage over time.

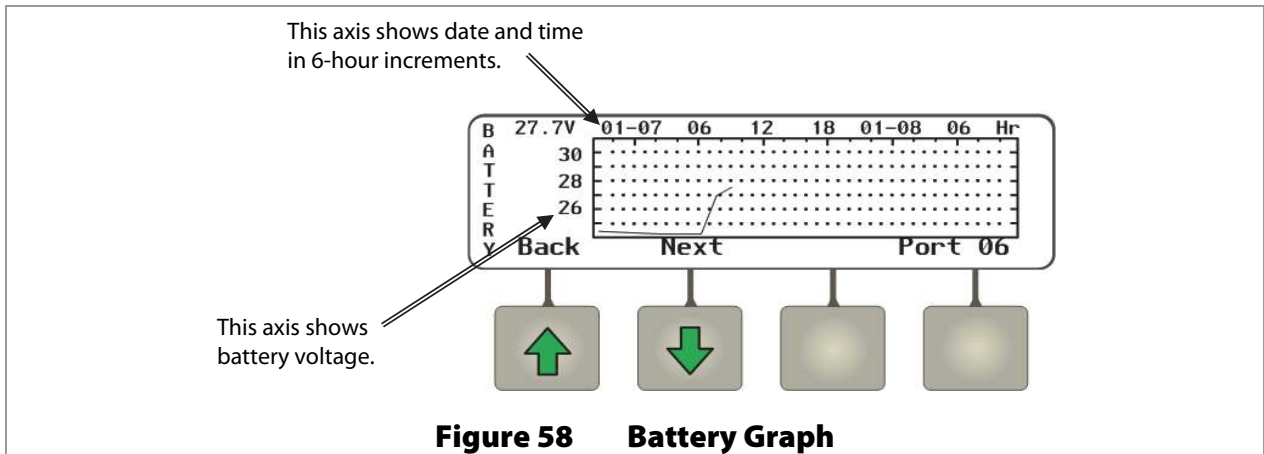

The **<Next>** soft key brings up a screen showing changes in PV voltage over time.

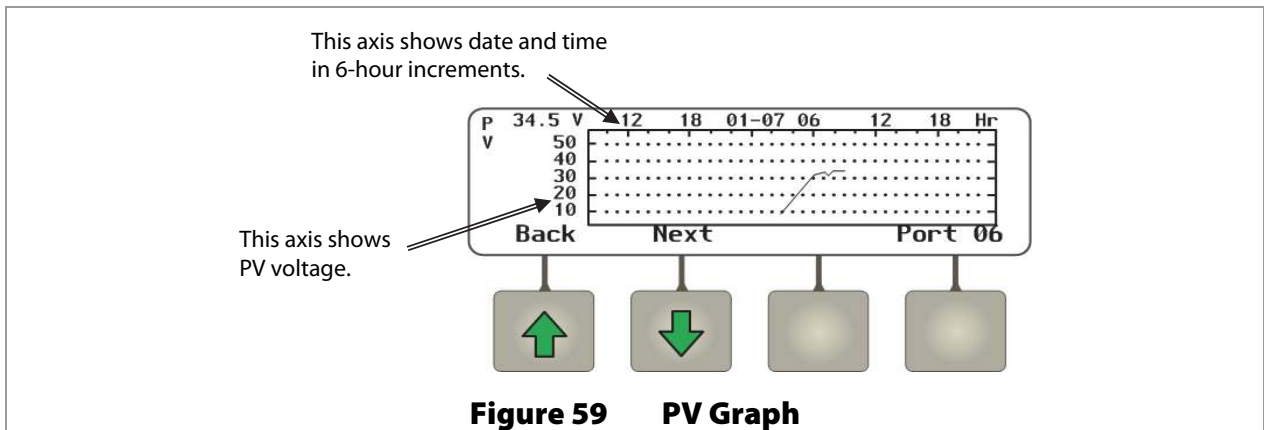

Continuing to press the **<Next>** soft key will proceed through the same graphs again from the beginning.

Menu Structure in the MATE3

Figure 60 shows the MATE3 menu structure for adjusting the FLEXmax charge controller settings.

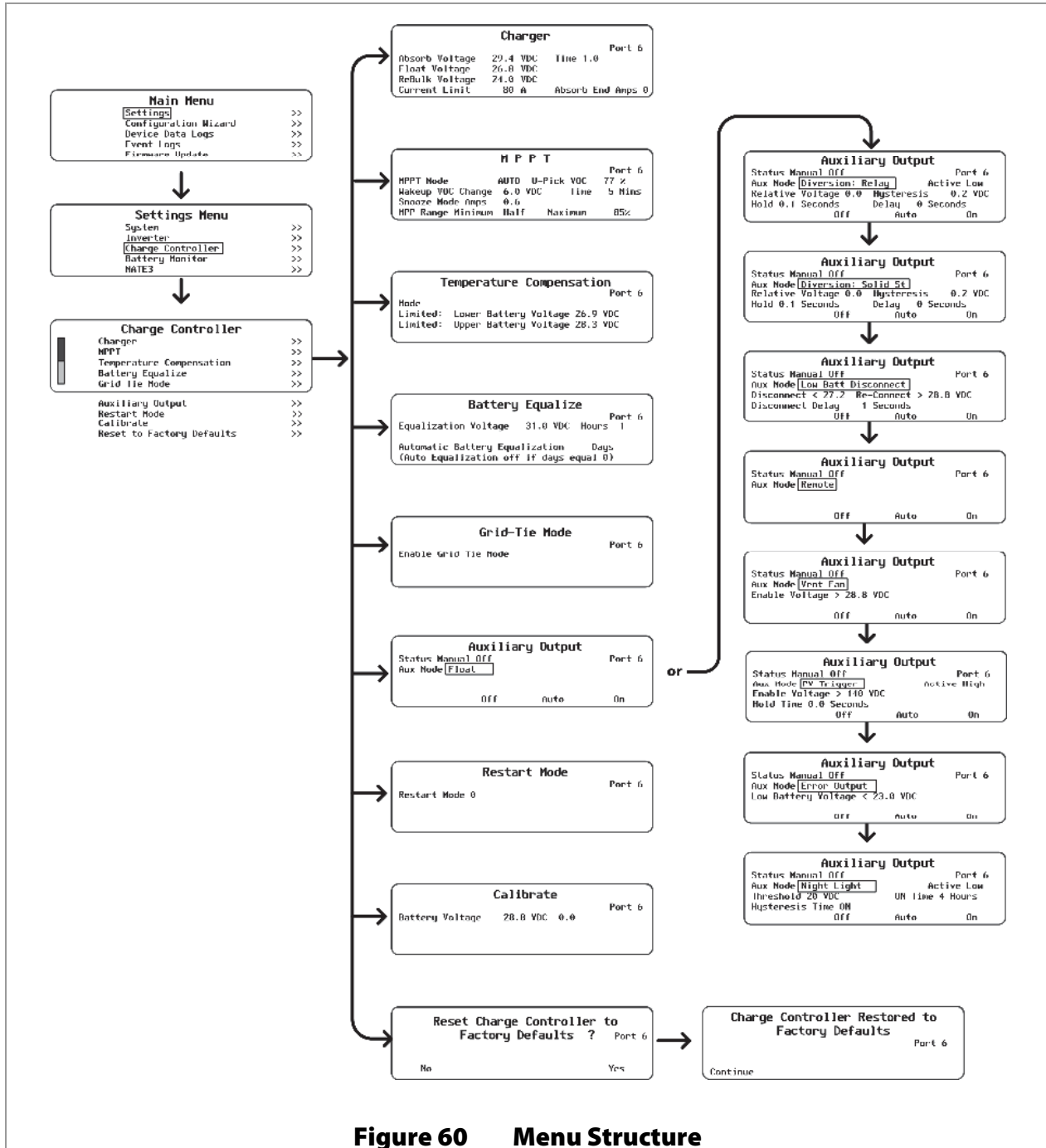

Figure 60 Menu Structure

The **Main Menu** shown above is accessed with the LOCK button and a password. Use the MATE3’s control wheel to move up and down between menus (or options within a menu). Use the center button on the control wheel to make a selection. (See the MATE3 manual for more information.)

Some menus may not be accessible if the user access levels are restricted.

Charge Controller Settings

Charge Controller menu options include the following:

- Charger**-----> See page 64.
- MPPT**-----> See page 64.
- Temperature Compensation**-----> See page 65.
- Battery Equalize**-----> See page 65.
- Grid-Tie Mode**-----> See page 65.
- Auxiliary Output**-----> See page 66.
- Restart Mode**-----> See page 67.
- Calibrate**-----> See page 68.
- Reset Charge Controller to Factory Defaults**-----> See page 68.

Charger



IMPORTANT:

Battery charger settings need to be correct for a given battery type. Always follow battery manufacturer recommendations. Making incorrect settings, or leaving them at factory default settings, may cause the batteries to be undercharged or overcharged.

The charge controller uses a “three-stage” battery charging cycle which utilizes multiple settings. This menu controls the voltages and timers for the battery charger. See page 96 for an explanation of the three-stage cycle and a description of the individual stages.

<table border="1" style="width: 100%; border-collapse: collapse;"> <tr> <th colspan="4" style="text-align: center;">Charger</th> <th style="text-align: right;">Port 6</th> </tr> <tr> <td>Absorb Voltage</td> <td>29.4 VDC</td> <td>Time</td> <td>1.0</td> <td></td> </tr> <tr> <td>Float Voltage</td> <td>26.8 VDC</td> <td></td> <td></td> <td></td> </tr> <tr> <td>ReBulk Voltage</td> <td>24.0 VDC</td> <td></td> <td></td> <td></td> </tr> <tr> <td>Current Limit</td> <td>80 A</td> <td>Absorb End Amps</td> <td>0</td> <td></td> </tr> </table>	Charger				Port 6	Absorb Voltage	29.4 VDC	Time	1.0		Float Voltage	26.8 VDC				ReBulk Voltage	24.0 VDC				Current Limit	80 A	Absorb End Amps	0		<p>Set Points:</p> <ul style="list-style-type: none"> > Absorb Voltage > (Absorb) Time > Float Voltage > Rebulk Voltage > Current Limit > Absorb End Amps
Charger				Port 6																						
Absorb Voltage	29.4 VDC	Time	1.0																							
Float Voltage	26.8 VDC																									
ReBulk Voltage	24.0 VDC																									
Current Limit	80 A	Absorb End Amps	0																							

Figure 61 Charger

MPPT

The charge controller uses a maximum power point tracking (MPPT) algorithm which manipulates the output of the PV array to harvest maximum wattage. Although this function is automatic, this menu allows the user to adjust many of its parameters for special applications. See page 47, 48, and 100.

<table border="1" style="width: 100%; border-collapse: collapse;"> <tr> <th colspan="4" style="text-align: center;">M P P T</th> <th style="text-align: right;">Port 6</th> </tr> <tr> <td>MPPT Mode</td> <td>AUTO</td> <td>U-Pick VOC</td> <td>77 %</td> <td></td> </tr> <tr> <td>Wakeup VOC Change</td> <td>6.0 VDC</td> <td>Time</td> <td>5 Mins</td> <td></td> </tr> <tr> <td>Snooze Mode Amps</td> <td>0.6</td> <td></td> <td></td> <td></td> </tr> <tr> <td>MPP Range Minimum</td> <td>Half</td> <td>Maximum</td> <td>85%</td> <td></td> </tr> </table>	M P P T				Port 6	MPPT Mode	AUTO	U-Pick VOC	77 %		Wakeup VOC Change	6.0 VDC	Time	5 Mins		Snooze Mode Amps	0.6				MPP Range Minimum	Half	Maximum	85%		<p>Set Points:</p> <ul style="list-style-type: none"> > MPPT Mode > U-Pick VOC > Wakeup VOC Change VDC and Wakeup VOC Change Time – The FLEXmax screen refers to these items under the title “Wakeup Mode” > Snooze Mode Amps > MPP Range Minimum and MPP Range Maximum – The FLEXmax screen refers to these items under the title “Mpp Range Limit %”
M P P T				Port 6																						
MPPT Mode	AUTO	U-Pick VOC	77 %																							
Wakeup VOC Change	6.0 VDC	Time	5 Mins																							
Snooze Mode Amps	0.6																									
MPP Range Minimum	Half	Maximum	85%																							

Figure 62 MPPT

Temperature Compensation

When equipped with the Remote Temperature Sensor (RTS), the charge controller compensates for temperature changes by raising or lowering its charging voltages. However, in some cases the sensitivity of other DC devices may require this temperature compensation to be limited. This menu allows the user to manually adjust the upper and lower limits of temperature compensation. See page 97 for an explanation of compensation. See page 50 for the **FLEXmax RTS Compensation** menu.

<p style="text-align: center;">Temperature Compensation Port 6</p> <p>Mode Wide Limited: Lower Battery Voltage 26.9 VDC Limited: Upper Battery Voltage 28.3 VDC</p>	<p>Set Points:</p> <ul style="list-style-type: none"> ➤ Mode ➤ Limited: Lower Battery Voltage ➤ Limited: Upper Battery Voltage <p>The FLEXmax menu features these items as options under "RTS Compensation."</p>
---	---

Figure 63 Temperature Compensation

Battery Equalize

	<p>CAUTION: Battery Damage</p> <ul style="list-style-type: none"> ➤ Do not equalize any sealed battery types (VRLA, AGM, Gel, or other) unless approved by the manufacturer. Some batteries may suffer severe damage from equalization. ➤ Contact the battery manufacturer for recommendations on equalization voltage, duration, schedule, and/or advisability. Always follow manufacturer recommendations for equalization.
---	--

This menu controls the settings for the equalization process, which is used for battery maintenance. See page 42 for an explanation of equalization and how it relates to the regular charging process.

<p style="text-align: center;">Battery Equalize Port 6</p> <p>Equalization Voltage 31.0 VDC Hours 1 Automatic Battery Equalization 0 Days (Auto Equalization off if days equal 0)</p>	<p>Set Points:</p> <ul style="list-style-type: none"> ➤ Equalization Voltage ➤ (Equalization) Hours ➤ Automatic Battery Equalization
---	---

Figure 64 Battery Equalize

Grid-Tie Mode

	<p>IMPORTANT:</p> <p>This mode requires a grid-interactive inverter model (also known as grid-tie enabled). Not all inverters are grid-interactive. If the system is connected to an inverter that is not grid-interactive, Grid-Tie mode will not function if selected.</p>
---	--

This menu allows the charge controller to work more effectively with any grid-interactive inverters present on the HUB. See pages 44, 48, and 102 for more information.

<p style="text-align: center;">Grid-Tie Mode Port 6</p> <p>Enable Grid-Tie Mode N</p>	<p>Set Points:</p> <ul style="list-style-type: none"> ➤ Two options are available in this menu; N and Y: <ul style="list-style-type: none"> ~ N(No) disables Grid-Tie Mode; ~ Y(Yes) enables Grid-Tie Mode
---	---

Figure 65 Grid-Tie Mode

Auxiliary Output (Charge Controller)

This menu controls the output and functionality of the Auxiliary (AUX) output. The charge controller’s AUX terminals provide a 12 Vdc output that can deliver up to 0.2 Adc to control external loads. Typical loads include signaling a generator to start, sending a fault alarm signal, or running a fan to cool the inverter. See page 11 for an image of the AUX terminals. See page 27 for a description of AUX modes.

Auxiliary Output

Status Manual Off Port 6
 Aux Mode Float

Off Auto On

Set Points:

- **Status** – The **Auxiliary Output** status is controlled by the <Off>, <Auto>, and <On> soft keys.
- **Aux Mode** – Selects one of nine options: **Vent Fan, PV Trigger, Error Output, Night Light, Float, Diversion:Relay, Diversion:Solid St, Low Battery Disconnect,** and **Remote.**

Figure 66 Auxiliary Output

Aux Modes for the Charge Controller

Aux Modes include nine options with automatic criteria. The options appear in the following order when the wheel is drawn clockwise. The **Vent Fan** option appears first if the charge controller is set at factory default values; otherwise, it will tend to display the last option selected. (The options are described in greater detail beginning on page 29.)

NOTE: The **Remote** option allows the MATE3 to use the AUX output for AGS (see page 41). AGS is intended for systems with a HUB, inverter, and FLEXmax. If the MATE3 connects only to a FLEXmax, AGS will only work with DC genset programming. The other AGS functions will not work properly.

Vent Fan

Auxiliary Output

Status Manual Off Port 6
 Aux Mode Vent Fan
 Enable Voltage > 28.8

Off Auto On

Set Points:

- **Enable Voltage**

Figure 67 Vent Fan

PV Trigger

Auxiliary Output

Status Manual Off Port 6
 Aux Mode PV Trigger Active High
 Enable Voltage > 140 VDC
 Hold Time 0.0 Seconds

Off Auto On

Set Points:

- **Enable Voltage**
- **Hold Time**
- **Active: High or Low.**

Figure 68 PV Trigger

Error Output

Auxiliary Output

Status Manual Off Port 6
 Aux Mode Error Output
 Low Battery Voltage < 23.0 VDC

Off Auto On

Set Points:

- **Low Battery Voltage**

Figure 69 Error Output

Night Light

<div style="border: 1px solid black; padding: 5px; margin-bottom: 10px;"> <p style="text-align: center;">Auxiliary Output</p> <table style="width: 100%; border-collapse: collapse;"> <tr> <td>Status Manual Off</td> <td style="text-align: right;">Port 6</td> </tr> <tr> <td>Aux Mode Night Light</td> <td style="text-align: right;">Active Low</td> </tr> <tr> <td>Threshold 20 VDC</td> <td style="text-align: right;">ON Time 4 Hours</td> </tr> <tr> <td>Hysteresis Time ON</td> <td></td> </tr> <tr> <td style="text-align: center;">Off</td> <td style="text-align: center;">Auto</td> </tr> <tr> <td style="text-align: center;">0n</td> <td></td> </tr> </table> </div>	Status Manual Off	Port 6	Aux Mode Night Light	Active Low	Threshold 20 VDC	ON Time 4 Hours	Hysteresis Time ON		Off	Auto	0n		<p>Set Points :</p> <ul style="list-style-type: none"> ➤ Active: High or Low. ➤ Threshold ➤ Hysteresis Time ➤ ON Time
Status Manual Off	Port 6												
Aux Mode Night Light	Active Low												
Threshold 20 VDC	ON Time 4 Hours												
Hysteresis Time ON													
Off	Auto												
0n													

Figure 70 Night Light

Float

<div style="border: 1px solid black; padding: 5px; margin-bottom: 10px;"> <p style="text-align: center;">Auxiliary Output</p> <table style="width: 100%; border-collapse: collapse;"> <tr> <td>Status Manual Off</td> <td style="text-align: right;">Port 6</td> </tr> <tr> <td>Aux Mode Float</td> <td></td> </tr> <tr> <td style="text-align: center;">Off</td> <td style="text-align: center;">Auto</td> </tr> <tr> <td style="text-align: center;">0n</td> <td></td> </tr> </table> </div>	Status Manual Off	Port 6	Aux Mode Float		Off	Auto	0n		<p>Set Points: None</p>
Status Manual Off	Port 6								
Aux Mode Float									
Off	Auto								
0n									

Figure 71 Float

Diversion: Relay and Solid St

<div style="border: 1px solid black; padding: 5px; margin-bottom: 10px;"> <p style="text-align: center;">Auxiliary Output</p> <table style="width: 100%; border-collapse: collapse;"> <tr> <td>Status Manual Off</td> <td style="text-align: right;">Port 6</td> </tr> <tr> <td>Aux Mode Diversion: Relay</td> <td style="text-align: right;">Active Low</td> </tr> <tr> <td>Relative Voltage 0.0</td> <td style="text-align: right;">Hysteresis 0.2 VDC</td> </tr> <tr> <td>Hold 0.1 Seconds</td> <td style="text-align: right;">Delay 0 Seconds</td> </tr> <tr> <td style="text-align: center;">Off</td> <td style="text-align: center;">Auto</td> </tr> <tr> <td style="text-align: center;">0n</td> <td></td> </tr> </table> </div> <div style="border: 1px solid black; padding: 5px;"> <p style="text-align: center;">Auxiliary Output</p> <table style="width: 100%; border-collapse: collapse;"> <tr> <td>Status Manual Off</td> <td style="text-align: right;">Port 6</td> </tr> <tr> <td>Aux Mode Diversion: Solid St</td> <td></td> </tr> <tr> <td>Relative Voltage 0.0</td> <td style="text-align: right;">Hysteresis 0.2 VDC</td> </tr> <tr> <td>Hold 0.1 Seconds</td> <td style="text-align: right;">Delay 0 Seconds</td> </tr> <tr> <td style="text-align: center;">Off</td> <td style="text-align: center;">Auto</td> </tr> <tr> <td style="text-align: center;">0n</td> <td></td> </tr> </table> </div>	Status Manual Off	Port 6	Aux Mode Diversion: Relay	Active Low	Relative Voltage 0.0	Hysteresis 0.2 VDC	Hold 0.1 Seconds	Delay 0 Seconds	Off	Auto	0n		Status Manual Off	Port 6	Aux Mode Diversion: Solid St		Relative Voltage 0.0	Hysteresis 0.2 VDC	Hold 0.1 Seconds	Delay 0 Seconds	Off	Auto	0n		<p>Set Points (NOTE: All items function identically for both <i>Diversion: Relay</i> and <i>Diversion: Solid St</i>, except for <i>Active: High or Low</i>):</p> <ul style="list-style-type: none"> ➤ Active: High or Low. (Not present in <i>Diversion: Solid St</i>) ➤ Relative Voltage ➤ Hysteresis ➤ Hold ➤ Delay
Status Manual Off	Port 6																								
Aux Mode Diversion: Relay	Active Low																								
Relative Voltage 0.0	Hysteresis 0.2 VDC																								
Hold 0.1 Seconds	Delay 0 Seconds																								
Off	Auto																								
0n																									
Status Manual Off	Port 6																								
Aux Mode Diversion: Solid St																									
Relative Voltage 0.0	Hysteresis 0.2 VDC																								
Hold 0.1 Seconds	Delay 0 Seconds																								
Off	Auto																								
0n																									

Figure 72 Diversion:Relay and Diversion: Solid St

Low Batt Disconnect

<div style="border: 1px solid black; padding: 5px; margin-bottom: 10px;"> <p style="text-align: center;">Auxiliary Output</p> <table style="width: 100%; border-collapse: collapse;"> <tr> <td>Status Manual Off</td> <td style="text-align: right;">Port 6</td> </tr> <tr> <td>Aux Mode Low Batt Disconnect</td> <td></td> </tr> <tr> <td>Disconnect < 27.2</td> <td style="text-align: right;">Re-Connect > 28.8 VDC</td> </tr> <tr> <td>Disconnect Delay 1 Seconds</td> <td></td> </tr> <tr> <td style="text-align: center;">Off</td> <td style="text-align: center;">Auto</td> </tr> <tr> <td style="text-align: center;">0n</td> <td></td> </tr> </table> </div>	Status Manual Off	Port 6	Aux Mode Low Batt Disconnect		Disconnect < 27.2	Re-Connect > 28.8 VDC	Disconnect Delay 1 Seconds		Off	Auto	0n		<p>Set Points:</p> <ul style="list-style-type: none"> ➤ Disconnect ➤ Re-Connect ➤ Disconnect Delay
Status Manual Off	Port 6												
Aux Mode Low Batt Disconnect													
Disconnect < 27.2	Re-Connect > 28.8 VDC												
Disconnect Delay 1 Seconds													
Off	Auto												
0n													

Figure 73 Low Batt Disconnect

Remote

<div style="border: 1px solid black; padding: 5px; margin-bottom: 10px;"> <p style="text-align: center;">Auxiliary Output</p> <table style="width: 100%; border-collapse: collapse;"> <tr> <td>Status Manual Off</td> <td style="text-align: right;">Port 6</td> </tr> <tr> <td>Aux Mode Remote</td> <td></td> </tr> <tr> <td style="text-align: center;">Off</td> <td style="text-align: center;">Auto</td> </tr> <tr> <td style="text-align: center;">0n</td> <td></td> </tr> </table> </div>	Status Manual Off	Port 6	Aux Mode Remote		Off	Auto	0n		<p>Set Points: None</p> <p>This mode can also be used for the MATE3's AGS function. See pages 41 and 66 for important information on this function.</p>
Status Manual Off	Port 6								
Aux Mode Remote									
Off	Auto								
0n									

Figure 74 Remote

Restart Mode

This item selects between continuous MPPT, or occasional MPPT restarts. (See pages 21 and 52.)

<div style="border: 1px solid black; padding: 5px; margin-bottom: 10px;"> <p style="text-align: center;">Restart Mode</p> <table style="width: 100%; border-collapse: collapse;"> <tr> <td>Restart Mode 0</td> <td style="text-align: right;">Port 6</td> </tr> </table> </div>	Restart Mode 0	Port 6	<p>Set Points:</p> <ul style="list-style-type: none"> ➤ 0– Continuous MPPT, 1– Automatic re-sweep every 90 minutes in MPPT charging, 2– Automatic re-sweep every 90 minutes in any mode.
Restart Mode 0	Port 6		

Figure 75 Restart Mode

Calibrate

The Calibrate menu allows adjustment of the charge controller’s battery voltmeter. If a particular controller’s readings do not match those of another device, or a hand-held meter, the calibration feature may improve consistency.

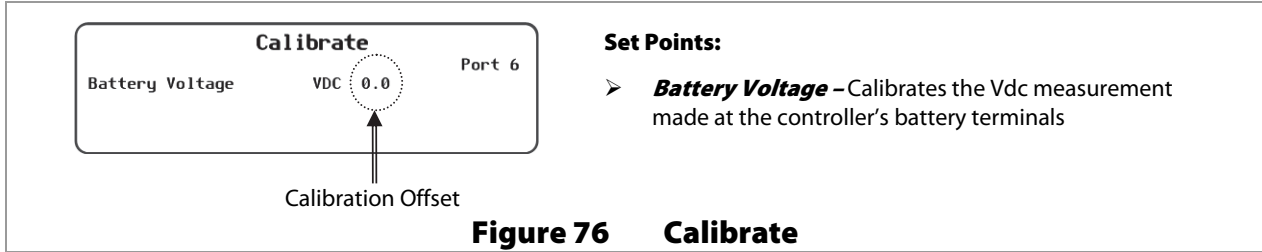

Figure 76 Calibrate

NOTE: Calibration does not change the actual voltage of the charge controller, only the reading of that voltage.

Also, measurements in places other than the charge controller’s terminals may differ regardless of calibration. For example, it is possible to get a different reading at the charge controller’s DC terminals than on the batteries. Connection problems, corrosion, and the effects of induction and resistance may all result in voltage differences. If this occurs, note that this is an issue with the system, not the charge controller. Calibration cannot correct for it.

Reset Charge Controller to Factory Defaults

This menu allows the user to erase all settings from the selected charge controller and start over with the values programmed at the factory. These values are listed on page 94.

To access the Reset to Factory Defaults menu:

1. Access the main menu as shown in Figure 16.
2. Select the **Settings** menu. (This option may be highlighted by default.)
3. Select **Charge Controller** in the device **Settings** menu.
4. Select the **Reset to Factory Defaults** menu.
5. Use the soft keys to select **No** or **Yes**.
 - If **<No>** is selected, the screen returns to the **Charge Controller** menu. No changes will be made to any settings.
 - If **<Yes>** is selected, the inverter’s settings will immediately change to the original factory values. The screen will display the message **Charge Controller Restored to Factory Defaults**. A **<Continue>** soft key will appear. Pressing this key will return the screen to the **Charge Controller** menu.
6. After resetting the charge controller to factory default parameters:
 - press the **<Continue>** soft key or the **Up** navigation key to return to the **Charge Controller** menu, or
 - press the **Top** navigation key to return to the **Settings** menu.

Press **<Continue>** to return to the **Charge Controller Menu**.

Figure 77 Restoring the Charge Controller to Factory Default Settings

Device Data Logs

Users of the MATE3 can create Device Data Logs for the FLEXmax charge controller. The Data Logs can then be uploaded and saved to an SD card.

Saving Data Logs for the FLEXmax Charge Controller

To create a data log for the FLEXmax Charge Controller:

1. Access the **Main Menu** as shown in Figure 16.
2. Select the **Device Data Logs** menu.
3. Select **FLEXmax Charge Controller** menu.
4. Select **Upload and Save Data Log** on the **FM Charge Controller Data Log** menu.
5. Select one of the two options.
 - Press **<New>** to give the new data log a unique name. Or
 - Press **<Save>** to save the data log over the name that is highlighted on the list.
6. After saving the data log is complete, press **<Continue>** to return to the **Upload and Save Data Log** screen.

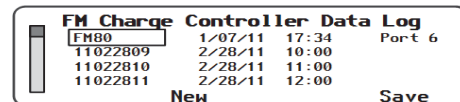
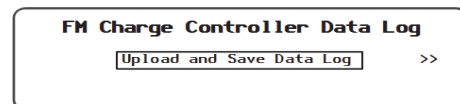
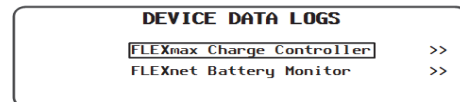
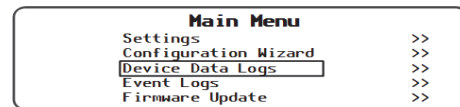

To save a new data log over the name highlighted on the list:

1. Use the control wheel to scroll through the list.
2. When the name to be replaced is highlighted, press **<Save>**.
3. Wait for the message confirming that the profile has been saved to the SD card.
4. Press **<Continue>** to return to the **Upload and Save Data Log** menu.

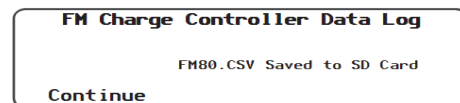
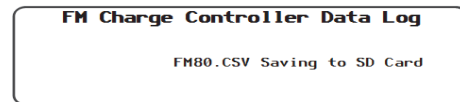

↓
Returns to the **Upload and Save Data Log** screen.

To create a new name for the data log (up to 8 characters maximum):

1. Use the control wheel to scroll through the available characters.
2. Use **<→>** and **<←>** to move to the next character location.
3. Press **<Delete>** to erase the character that is highlighted.
4. Press **<Save>** to save the new data log on the SD card.
4. Press **<Continue>** to return to the **Upload and Save Data Log** menu.

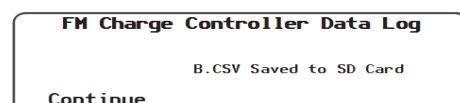
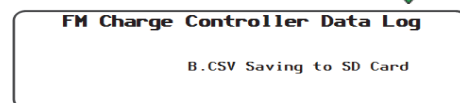

↓
Returns to the **Upload and Save Data Log** screen.

Figure 78 Uploading and Saving a Data Log for the FM Charge Controller

Data Log File Format

Information generated by this function will be saved on the SD card in a generic **.csv** file format, which can be read by most spreadsheet programs.

Data Logging example:

NOTE: This header line is NOT included in the download.

Date	AH	Kwh	Max Amps	Max Watts	Absorb Time	Float Time	Min Battery V	Max Battery V	MAX VOC
6/13/11	0	0	1.2	29	0:00	0:00	24.1	29.1	122
6/12/11	38	0.9	5.5	143	0:00	0:00	24.1	29	122
6/11/11	32	0.8	5.6	144	0:00	0:00	24.1	28.7	120
6/10/11	9	0.2	3.5	89	0:00	0:00	24.1	28.9	120
6/09/11	31	0.7	6.8	173	0:00	0:00	24.1	28.8	119

Figure 79 Data Log Example for the Charge Controller



MATE/MATE2 Screens

Summary Screens

If a FLEXnet DC is installed in the system, the following summary screens will be available.

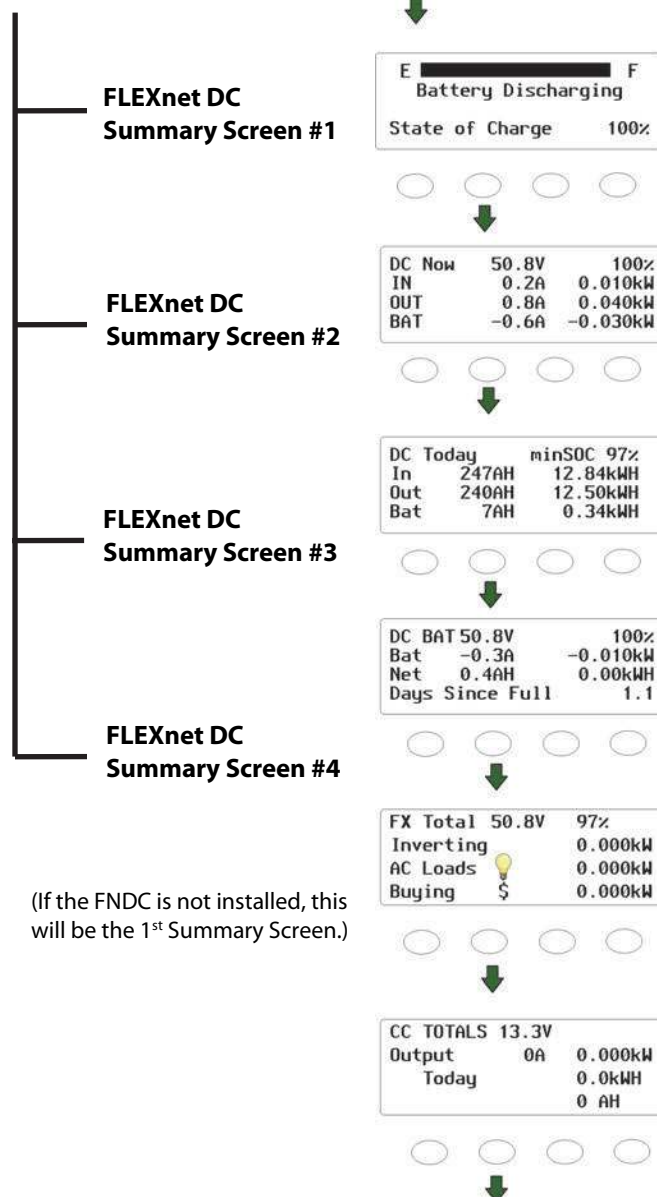

(If the FNDC is not installed, this will be the 1st Summary Screen.)

MAIN-----			
3:02:14P			
SUM	STATUS	SETUP	ADV

E	Battery Discharging		F
State of Charge		100%	

DC Now	50.8V	100%
IN	0.2A	0.010kW
OUT	0.8A	0.040kW
BAT	-0.6A	-0.030kW

DC Today	minSOC	97%
In	247AH	12.84kWH
Out	240AH	12.50kWH
Bat	7AH	0.34kWH

DC BAT	50.8V	100%
Bat	-0.3A	-0.010kW
Net	0.4AH	0.00kWH
Days Since Full	1.1	

FX Total	50.8V	97%
Inverting	0.000kW	
AC Loads	0.000kW	
Buying	0.000kW	

CC TOTALS	13.3V	
Output	0A	0.000kW
Today	0.0kWH	
	0 AH	

FX Inverter/Charger Summary Screen

FLEXmax Charge Controller Summary Screen

Figure 80 Summary Screens

Status Screens

To view the status screens of a FLEXmax 60 or FLEXmax 80 using a MATE, follow the illustration below. Changes to FLEXmax settings can only be changed from the charge controller user interface; changes can not be done when viewing these screens on a MATE.

MODE Screens

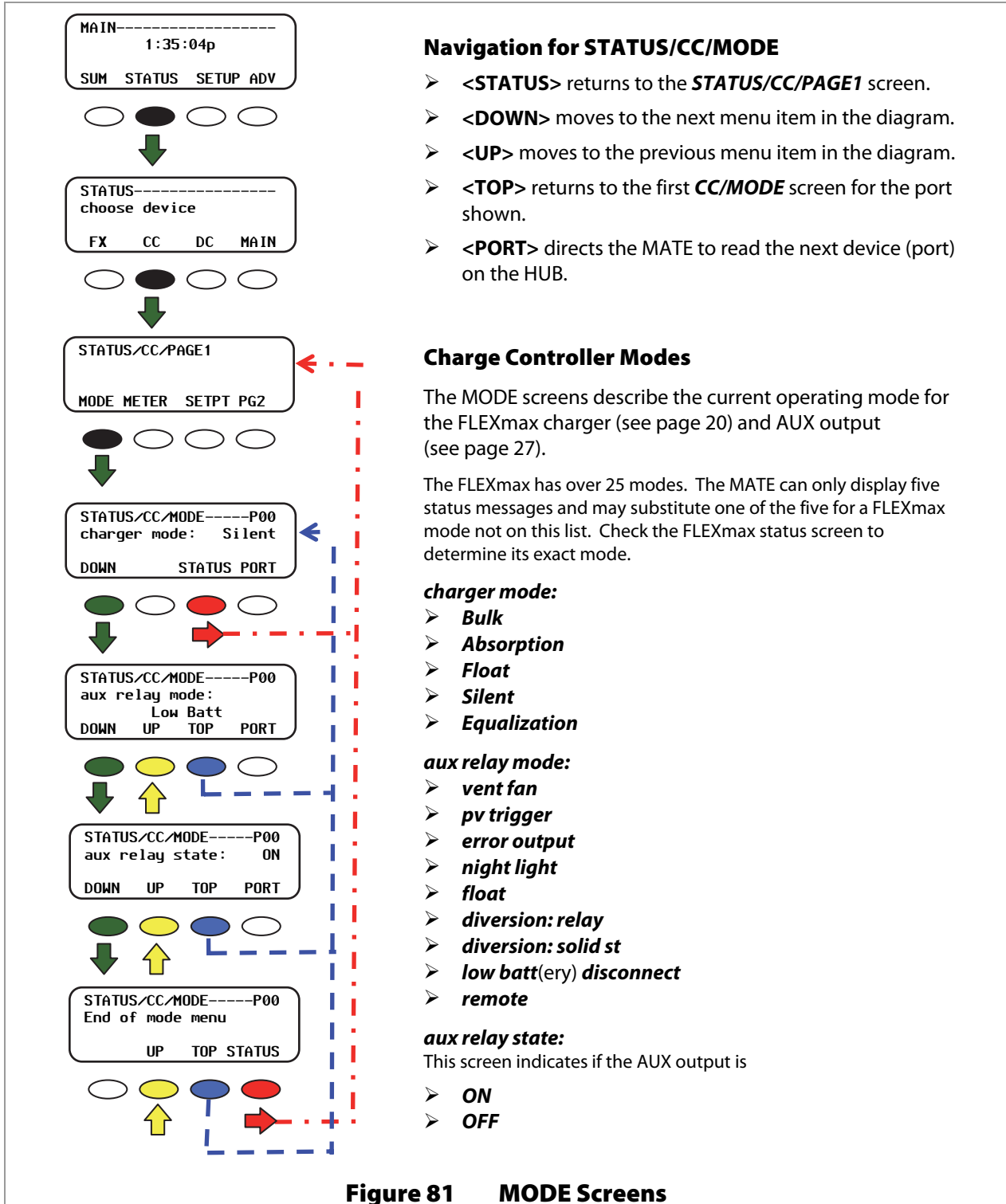

METER Screens

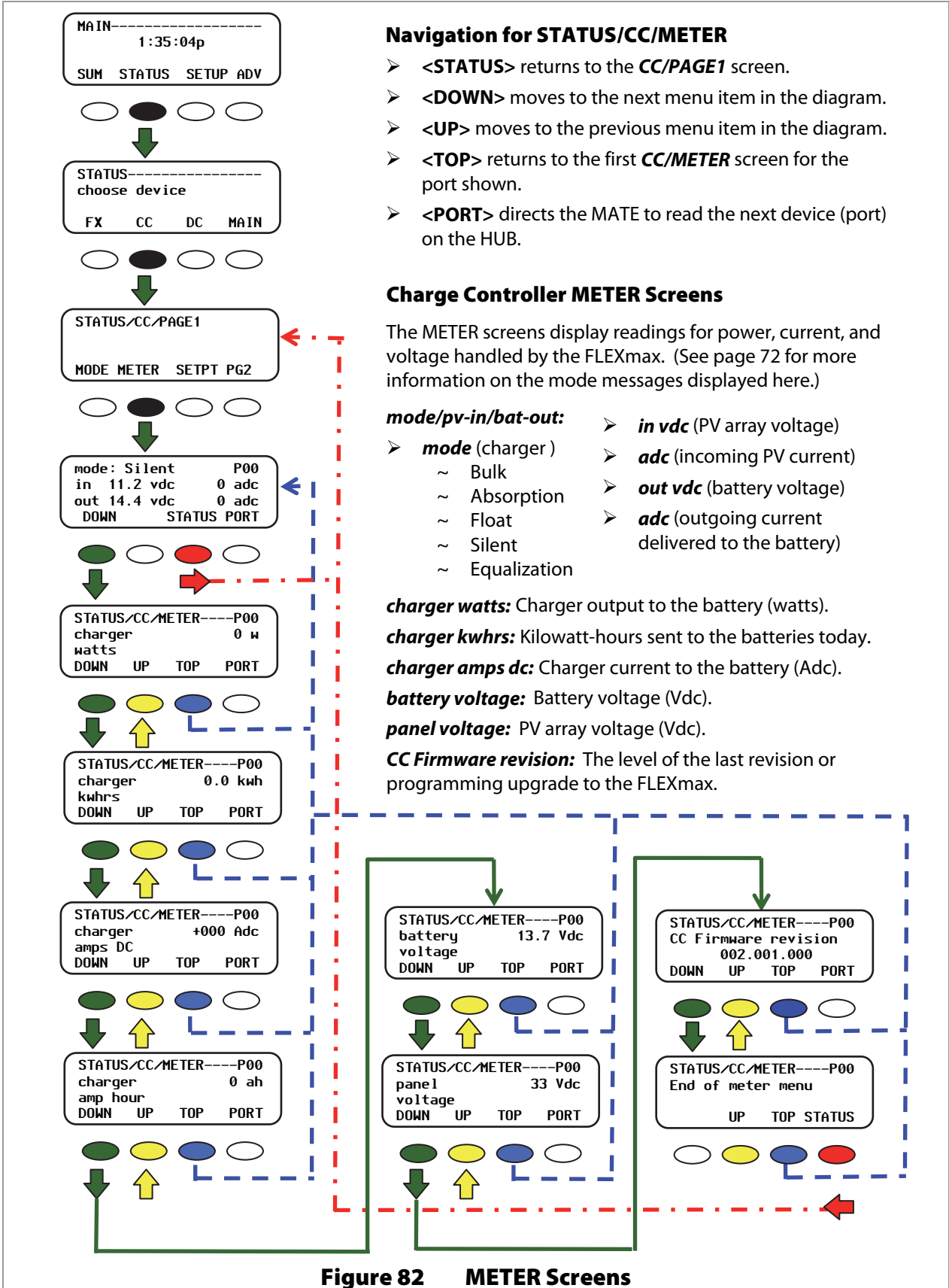

Navigation for STATUS/CC/METER

- <STATUS> returns to the **CC/PAGE1** screen.
- <DOWN> moves to the next menu item in the diagram.
- <UP> moves to the previous menu item in the diagram.
- <TOP> returns to the first **CC/METER** screen for the port shown.
- <PORT> directs the MATE to read the next device (port) on the HUB.

Charge Controller METER Screens

The METER screens display readings for power, current, and voltage handled by the FLEXmax. (See page 72 for more information on the mode messages displayed here.)

- mode/pv-in/bat-out:**
- **mode** (charger)
 - ~ Bulk
 - ~ Absorption
 - ~ Float
 - ~ Silent
 - ~ Equalization
 - **in vdc** (PV array voltage)
 - **adc** (incoming PV current)
 - **out vdc** (battery voltage)
 - **adc** (outgoing current delivered to the battery)

- charger watts:** Charger output to the battery (watts).
- charger kwhrs:** Kilowatt-hours sent to the batteries today.
- charger amps dc:** Charger current to the battery (Adc).
- battery voltage:** Battery voltage (Vdc).
- panel voltage:** PV array voltage (Vdc).
- CC Firmware revision:** The level of the last revision or programming upgrade to the FLEXmax.

Figure 82 METER Screens

SETPT Screens

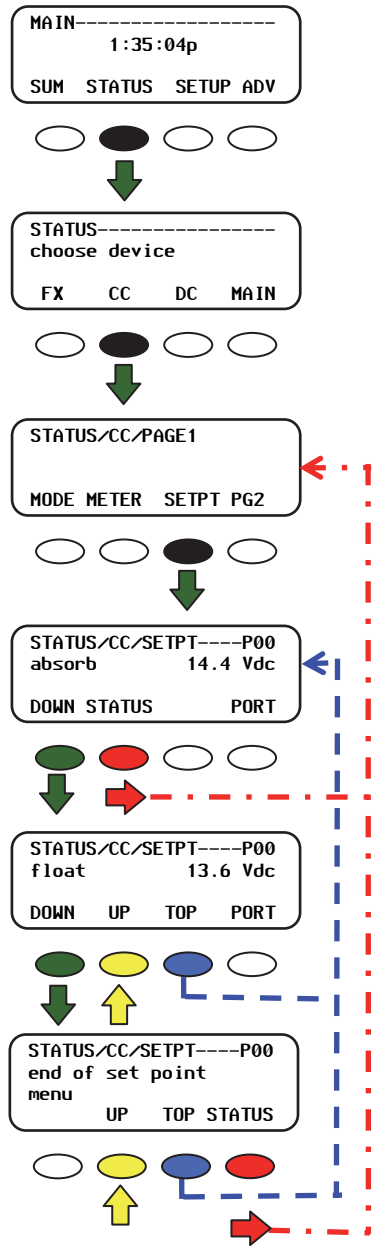

Navigation for STATUS/CC/SETPT

- <STATUS> returns to the **CC/PAGE1** screen.
- <DOWN> moves to the next menu item in the diagram.
- <UP> moves to the previous menu item in the diagram.
- <TOP> returns to the first **CC/SETPT** screen for the port shown.
- <PORT> directs the MATE to read the next device (port) on the HUB.

Charge Controller SETPT (set point) Screens

The SETPT screens display the current settings for the FLEXmax battery charger, as described on page 26.

- **Absorb**
- **Float**

Figure 83 SETPT Screens

LOG Screens

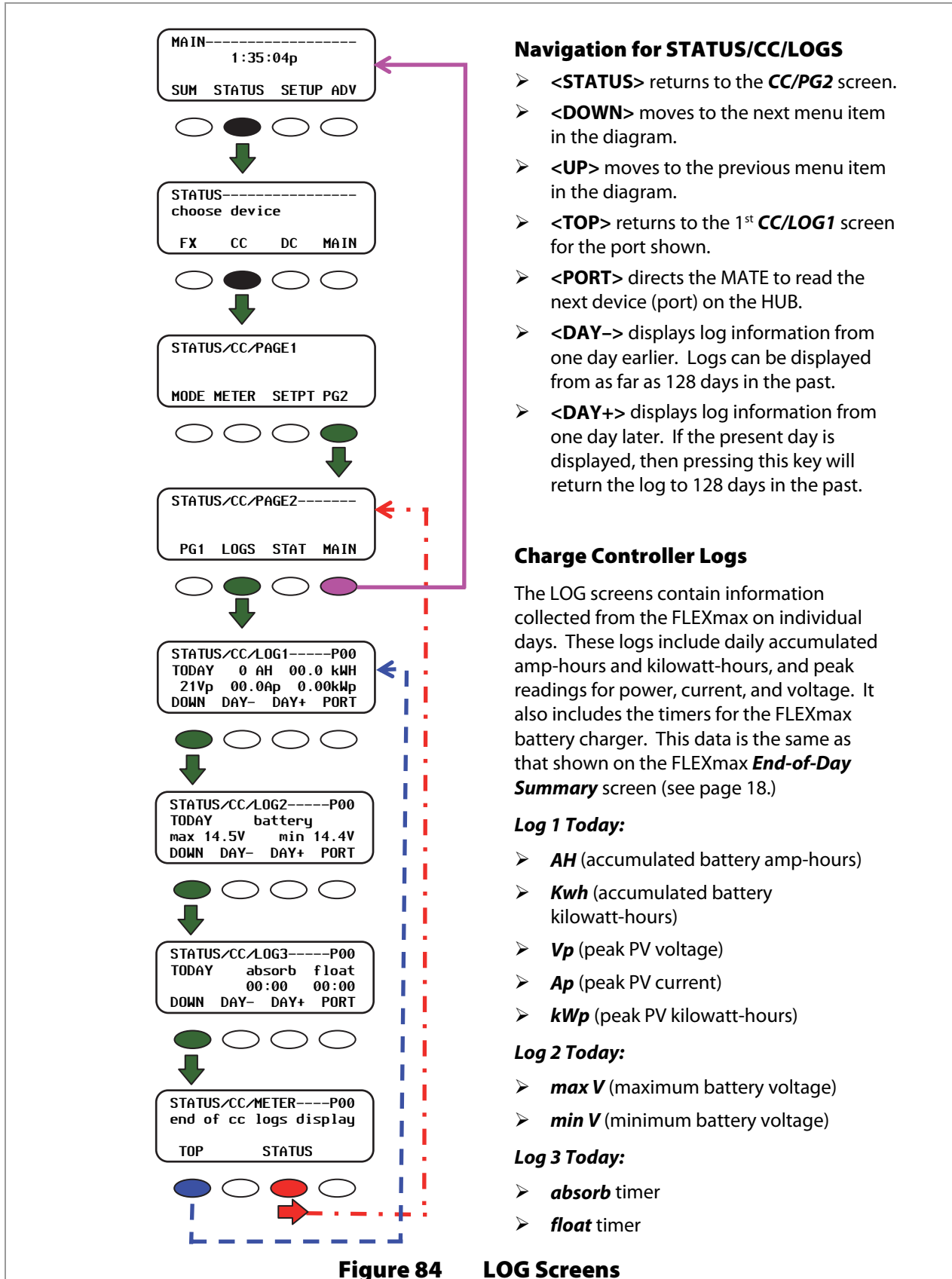

Figure 84 LOG Screens

STAT Screens

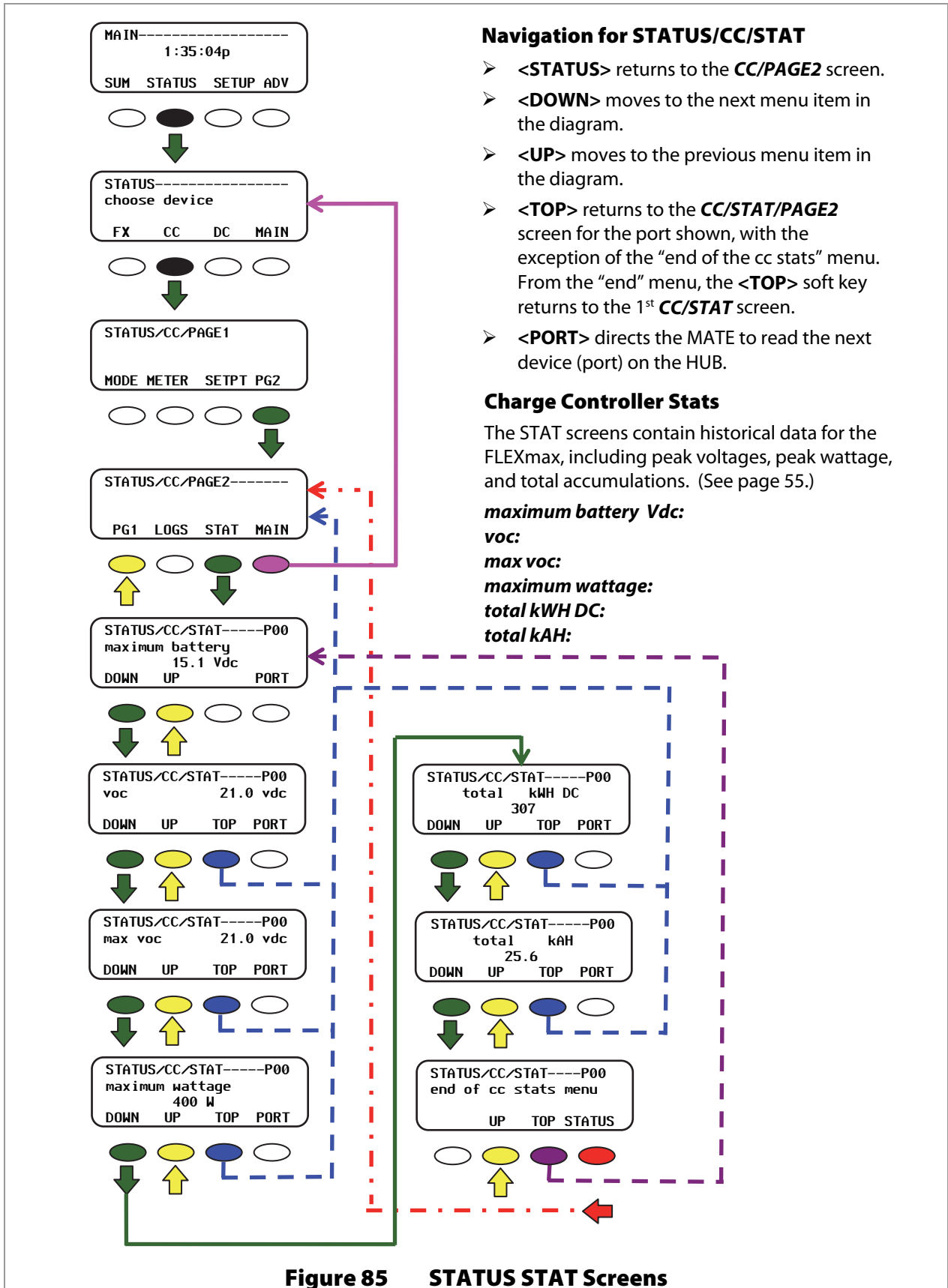

Figure 85 STATUS STAT Screens

Advanced Menu

The Advanced menus available in the MATE or MATE2 system display allow the following options:

- Change the settings of the FLEXmax battery charger and temperature compensation
- Change the parameters of the FLEXmax MPPT process
- Change the settings of the FLEXmax equalization process
- Calibrate the FLEXmax meters
- Change the settings of the Auxiliary output to run small AC or DC loads
- Start a generator using Advanced Generator Start (AGS) Mode (see page 41)
- Adjust the settings or functions of other OutBack devices which are connected to the system display (see appropriate manuals)

The following pages detail the MATE, or MATE2, Control Modes. Please note whenever a password is called for, the system password is:

141

Accessing the Advanced Menus

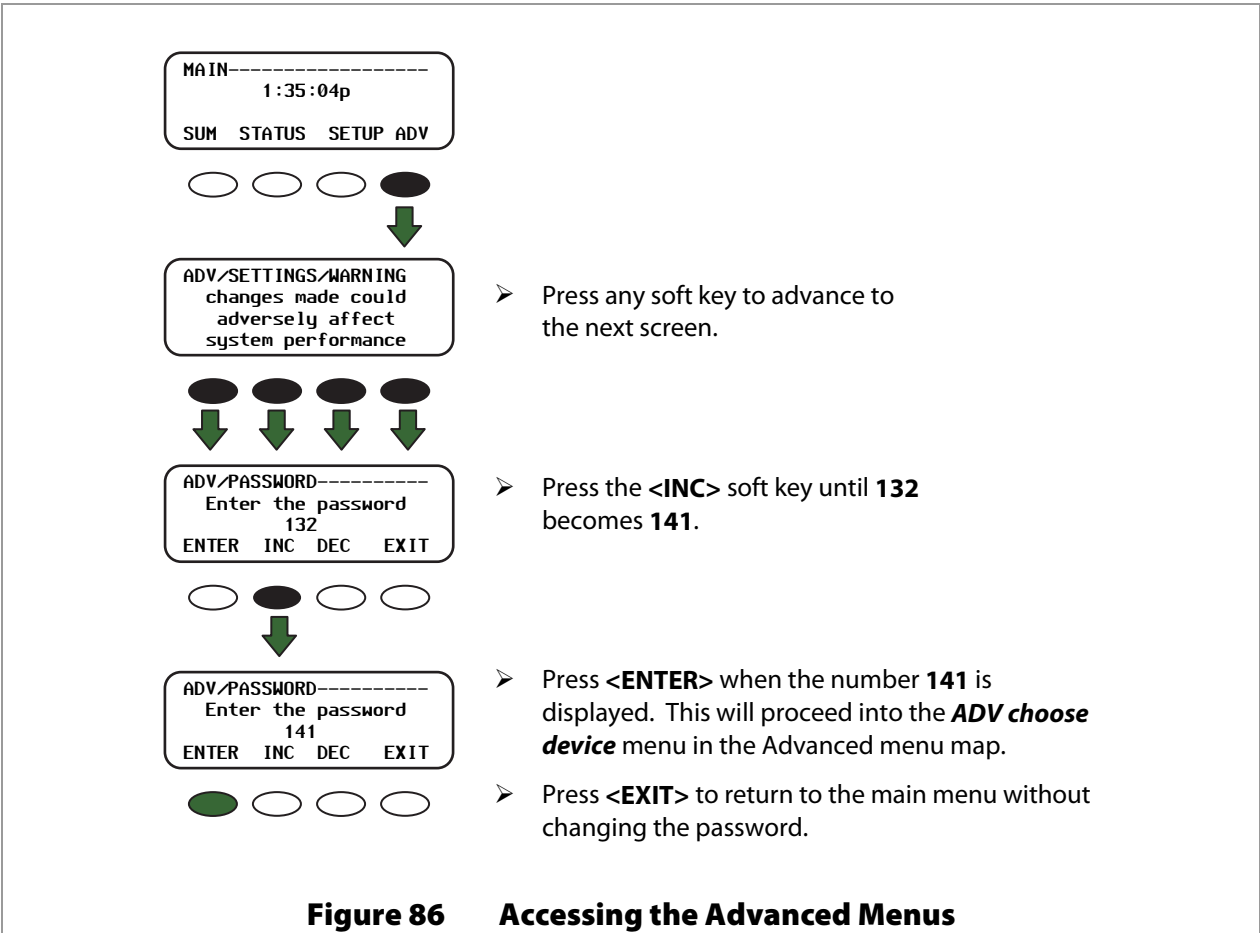

Figure 86 Accessing the Advanced Menu

CHGR Menu

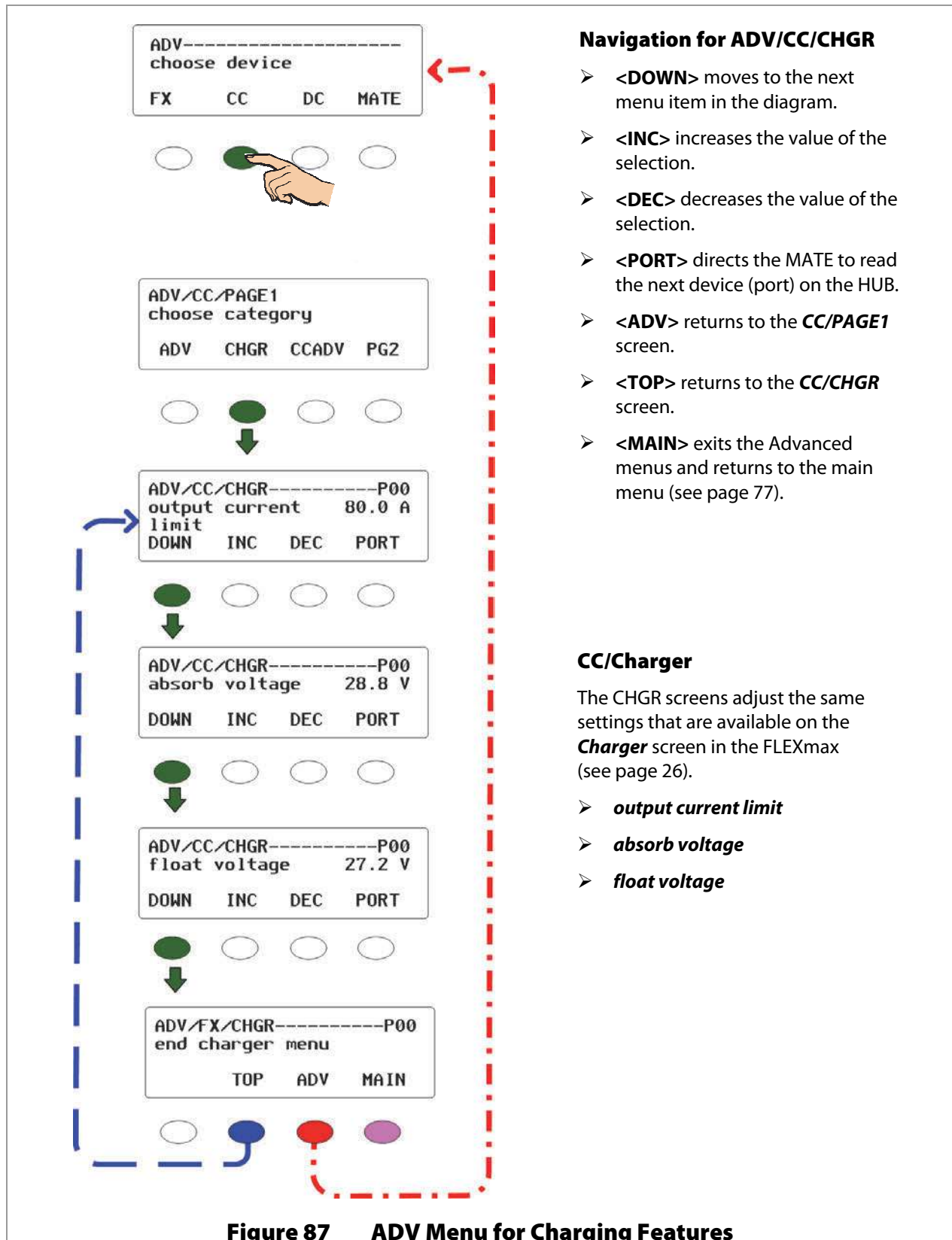

Figure 87 ADV Menu for Charging Features

CC ADVANCED Menu

CC/Advanced

The ADVANCED screens adjust the same settings that are available on the *Advanced* screen in the FLEXmax (see page 46). These settings relate to charging, MPPT, temperature compensation, and calibration.

Navigation for ADV/CC/ADVANCED

- <DOWN> moves to the next menu item in the diagram.
- <INC> increases the value of the selection.
- <DEC> decreases the value of the selection.
- <PORT> directs the MATE to the next device (port) on the HUB.
- <TOP> returns to the **CC/ADVANCED** screen.
- <ADV> returns to the **CC/PAGE1** screen.
- <MAIN> exits the Advanced menus and returns to the main menu (see page 77).

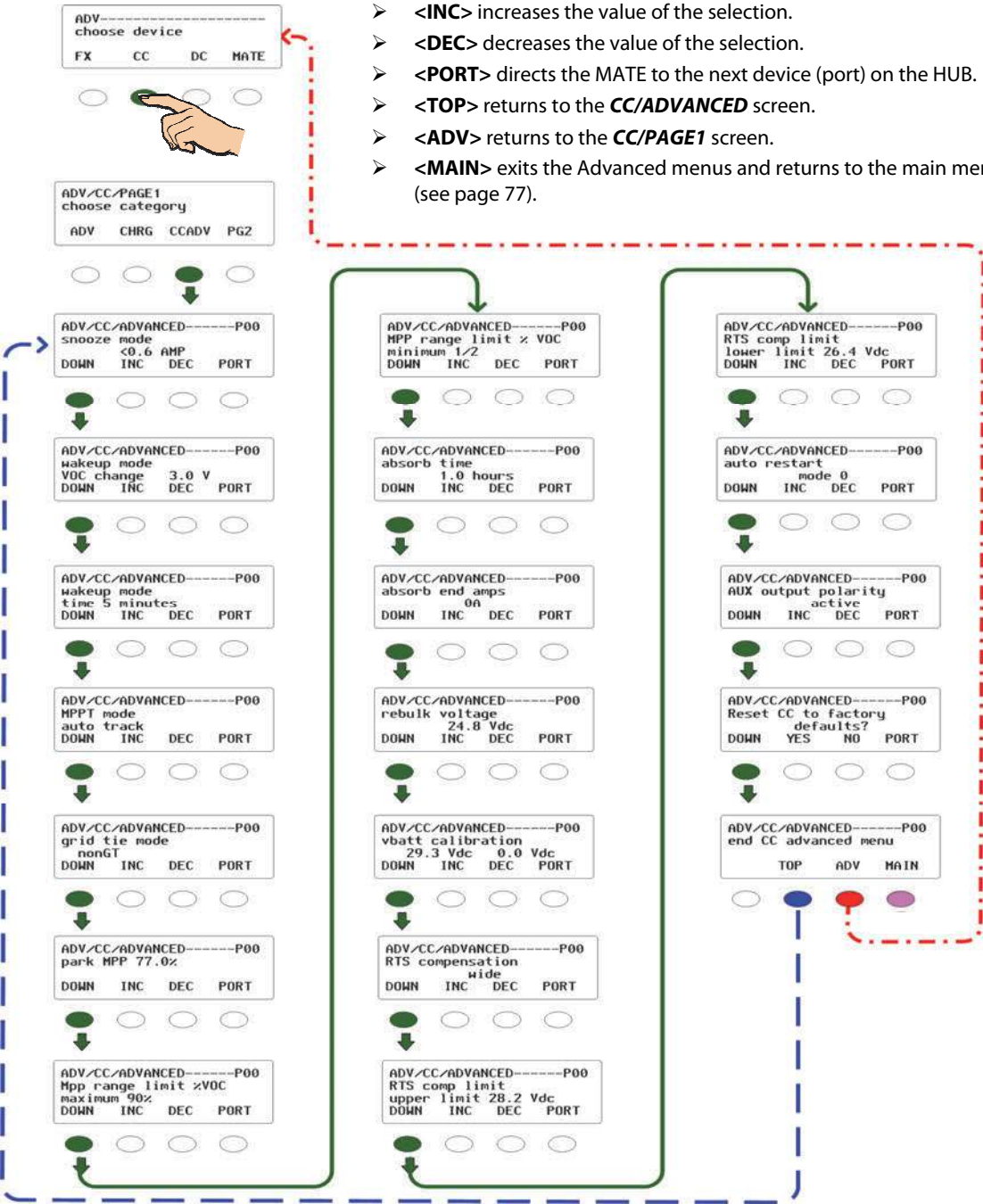

Figure 88 ADV Menu for the Advanced Charging Features

EQ Menu

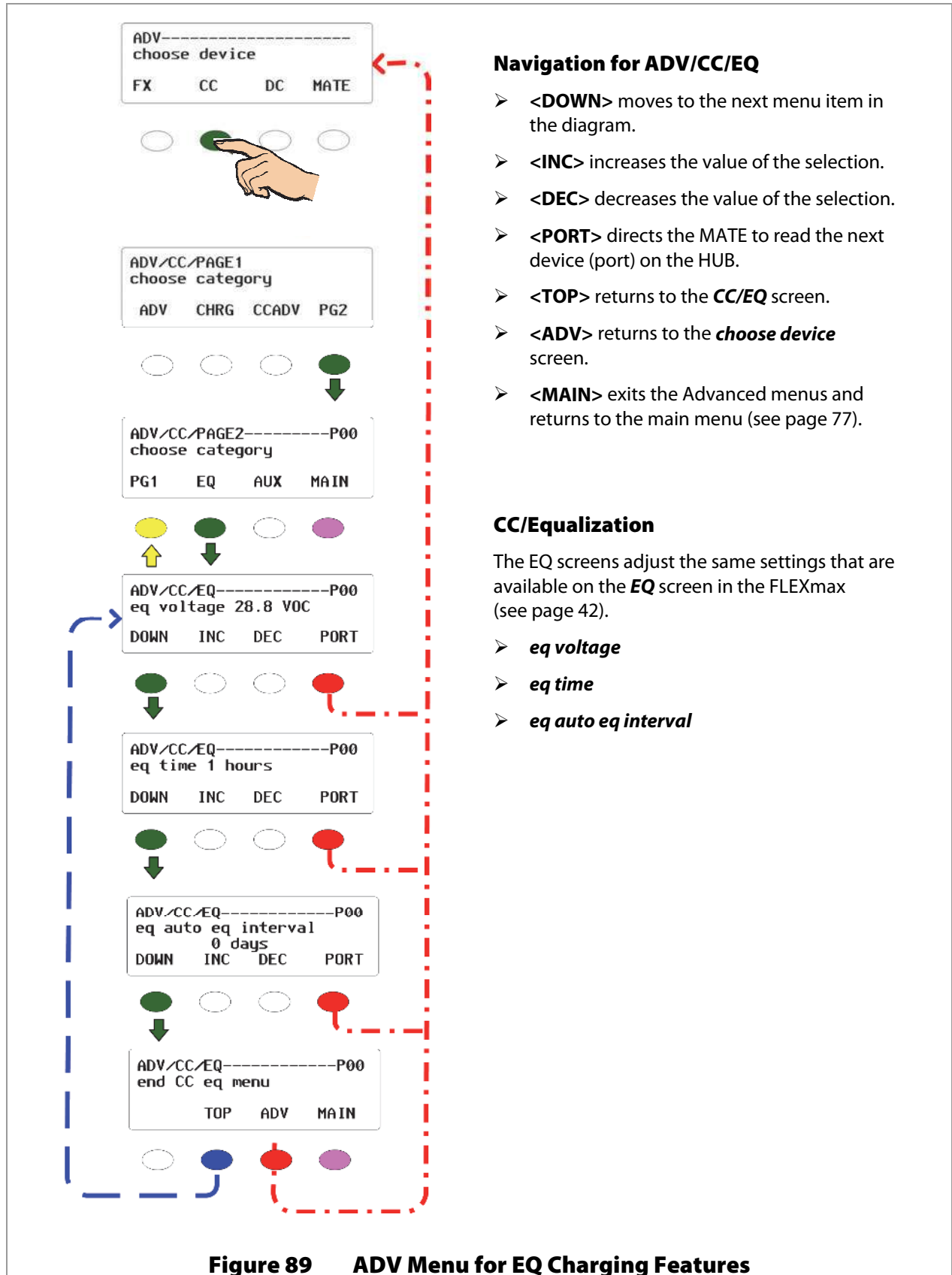

Figure 89 ADV Menu for EQ Charging Features

AUX Menu

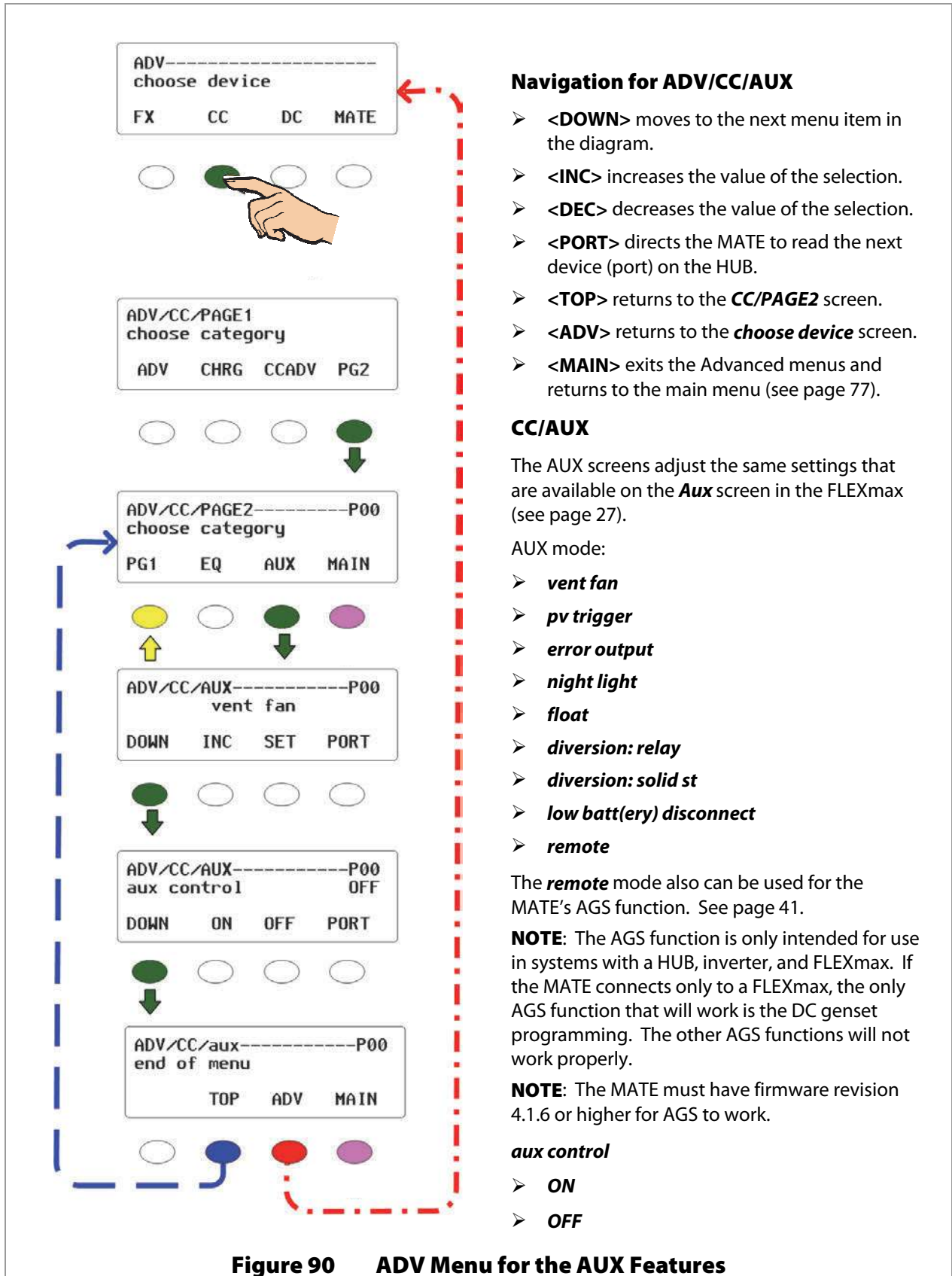

Figure 90 ADV Menu for the AUX Features

MATE and MATE2 Menu Maps for the FLEXmax

STATUS Menu Map

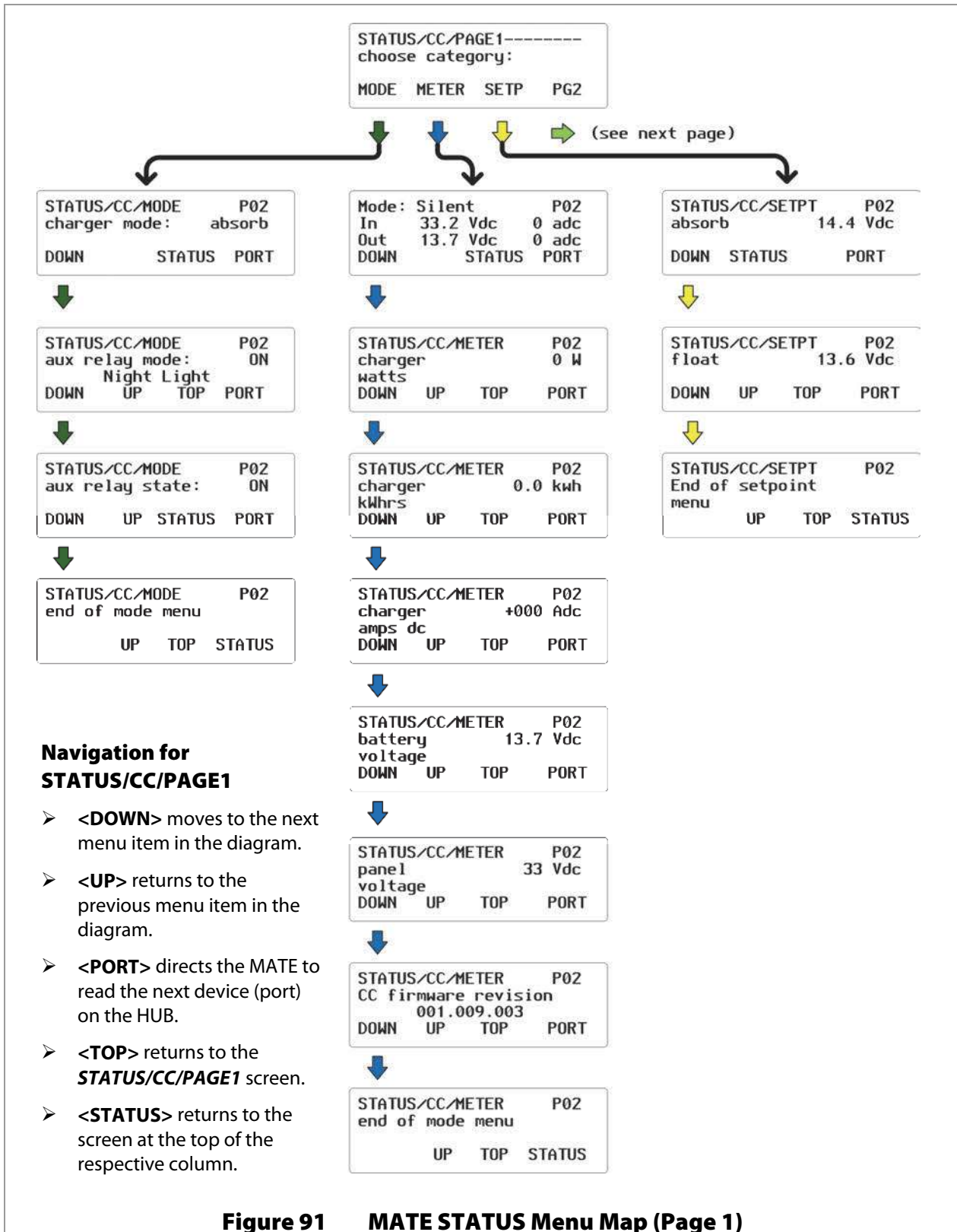
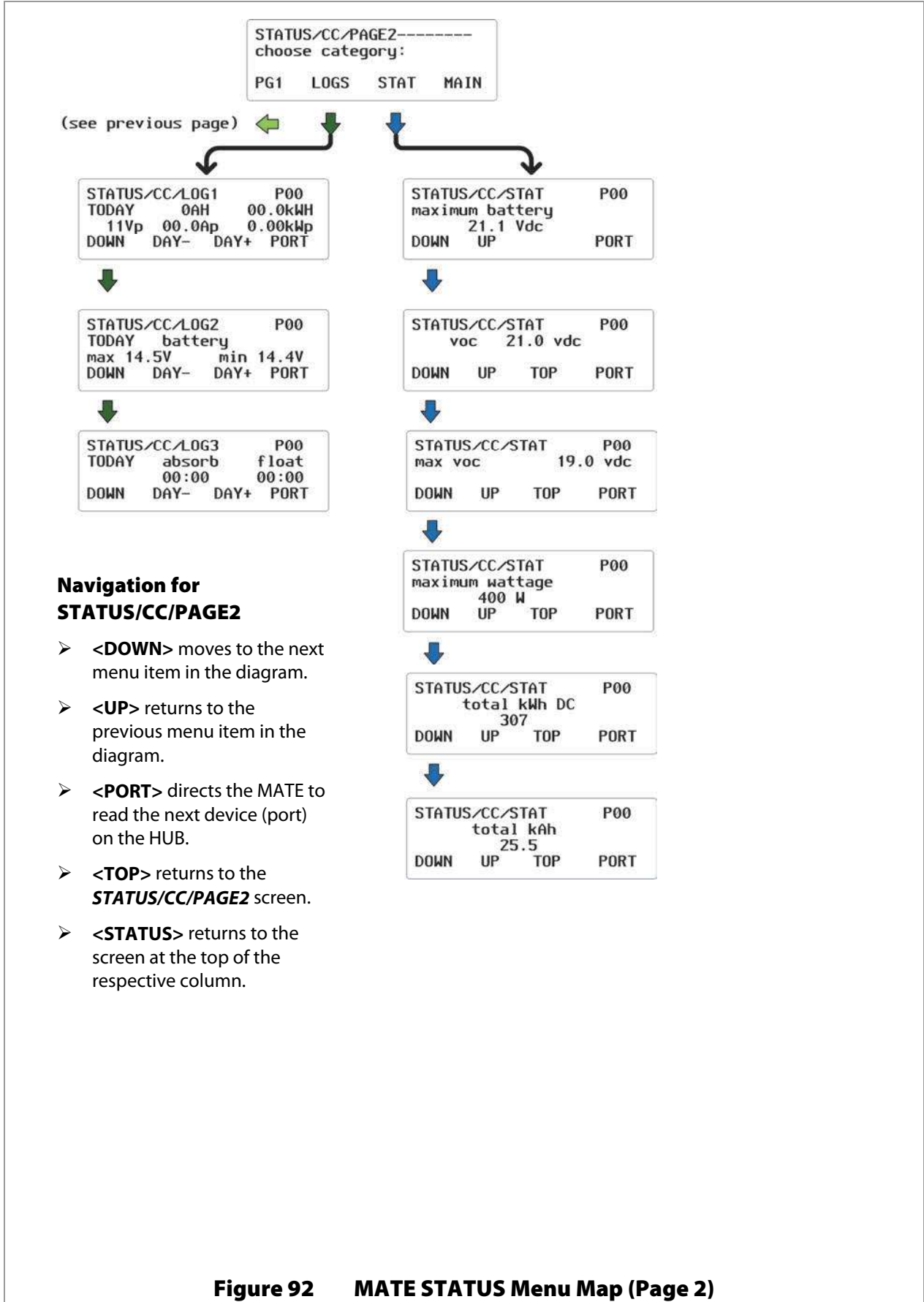

Figure 91 MATE STATUS Menu Map (Page 1)



Navigation for STATUS/CC/PAGE2

- <DOWN> moves to the next menu item in the diagram.
- <UP> returns to the previous menu item in the diagram.
- <PORT> directs the MATE to read the next device (port) on the HUB.
- <TOP> returns to the STATUS/CC/PAGE2 screen.
- <STATUS> returns to the screen at the top of the respective column.

Figure 92 MATE STATUS Menu Map (Page 2)

Advanced Menu Map

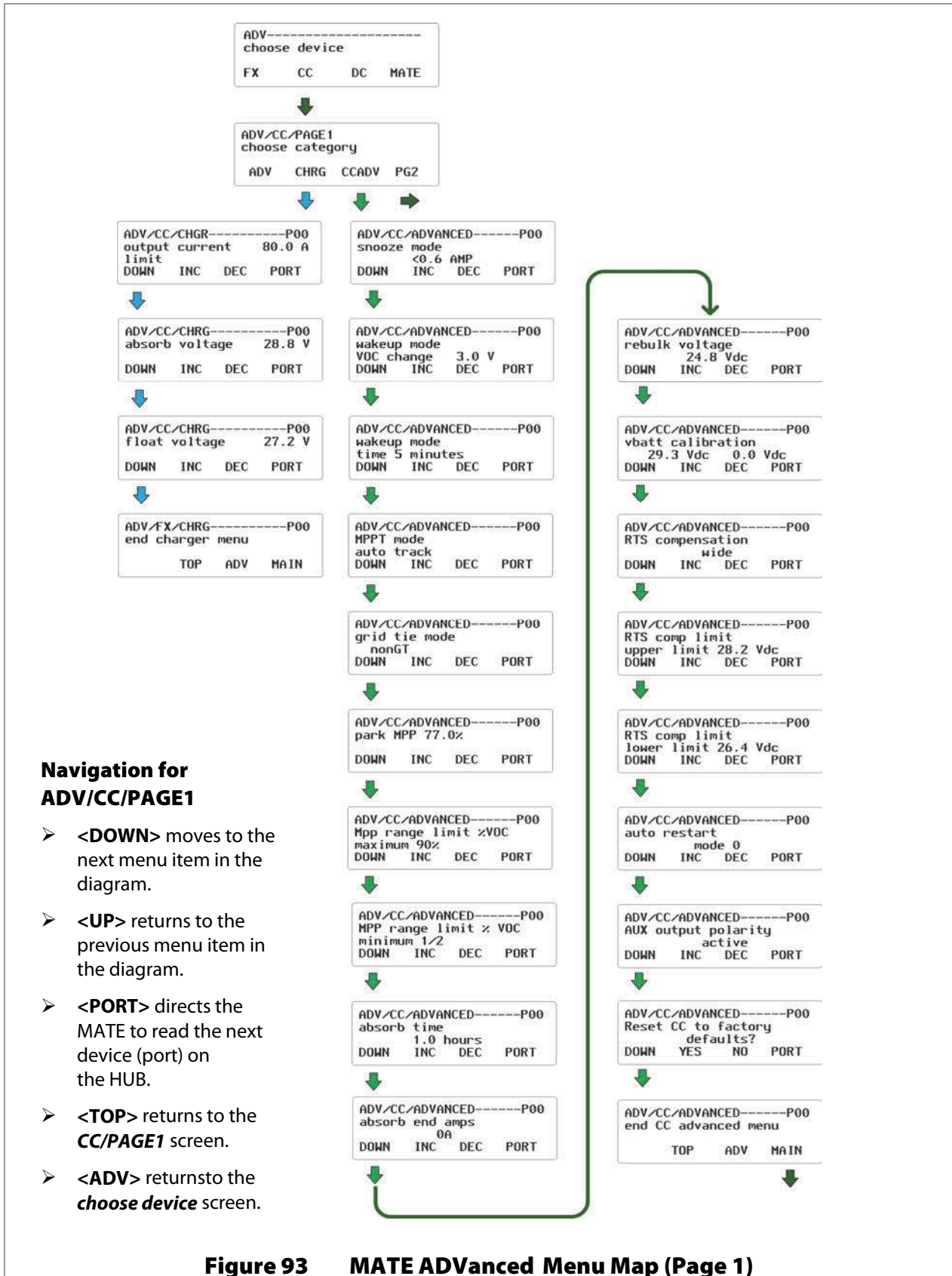

Figure 93 MATE ADVanced Menu Map (Page 1)

**Navigation for
ADV/CC/PAGE2**

- <DOWN> moves to the next menu item in the diagram.
- <UP> returns to the previous menu item in the diagram.
- <PORT> directs the MATE to read the next device (port) on the HUB.
- <TOP> returns to the **CC/PAGE2** screen.
- <ADV> returns to the **choose device** screen.

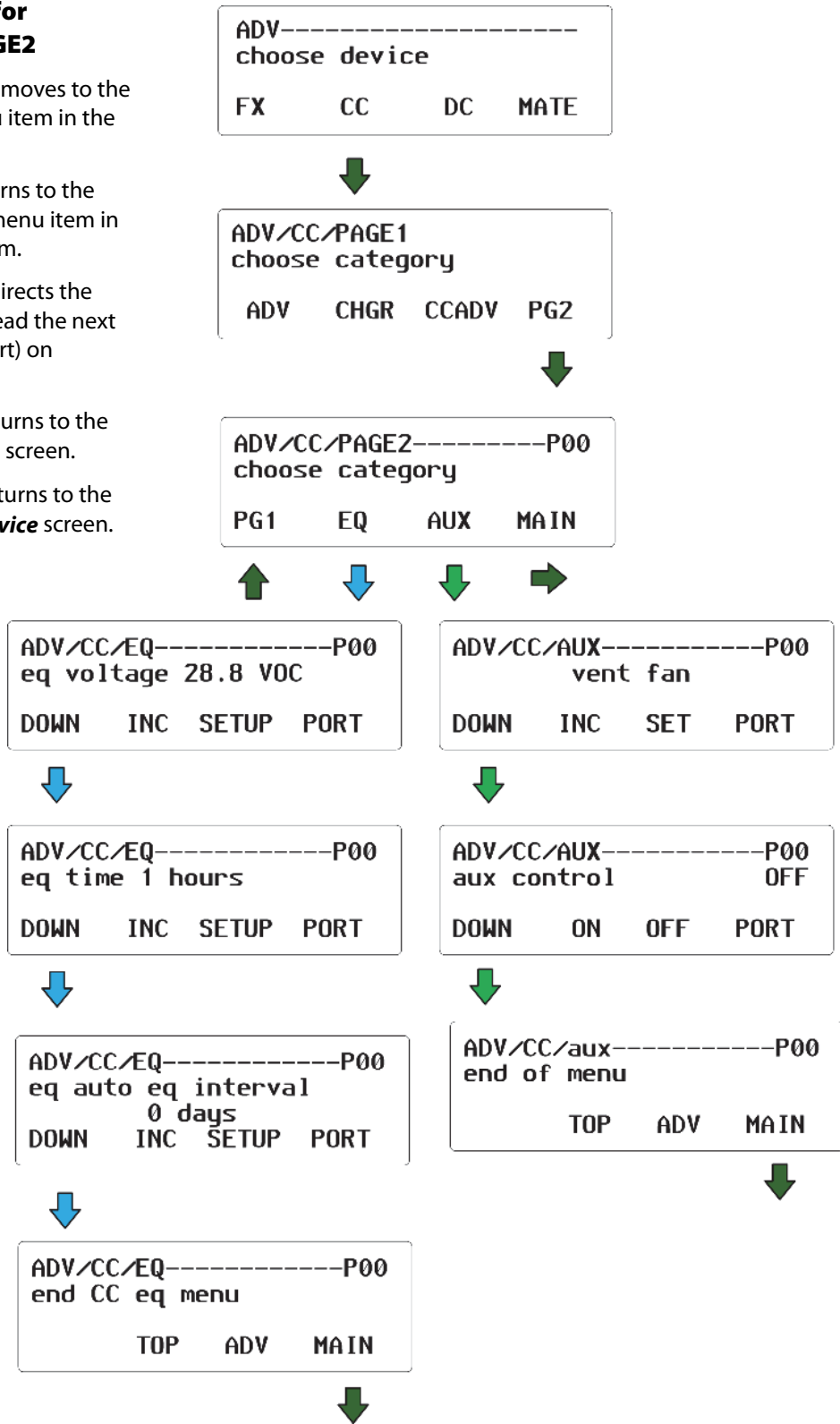

Figure 94 MATE ADVanced Menu Map (Page 2)

This page intentionally left blank.



Menu Maps for the FLEXmax

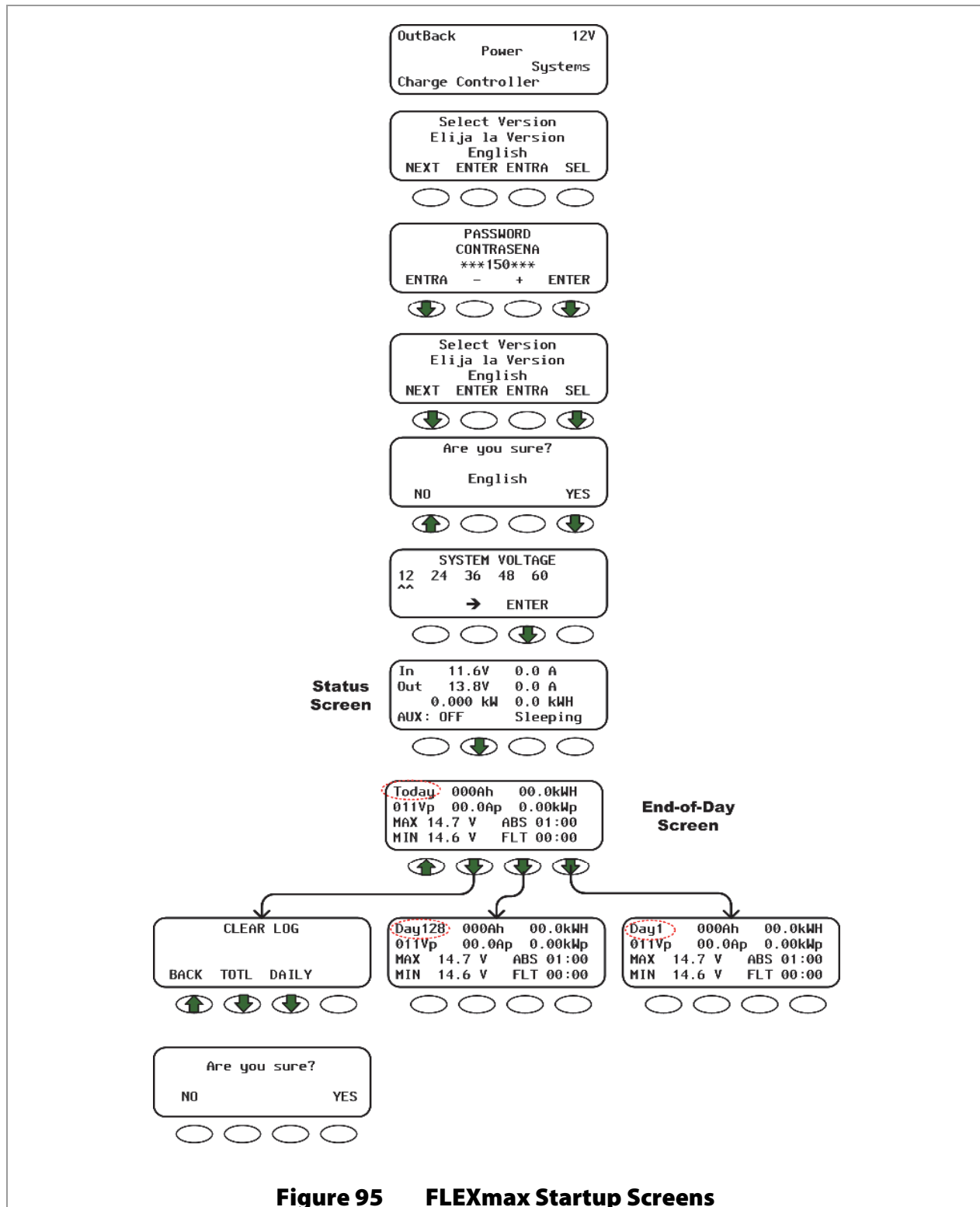

Figure 95 FLEXmax Startup Screens

FLEXmax Menu Maps

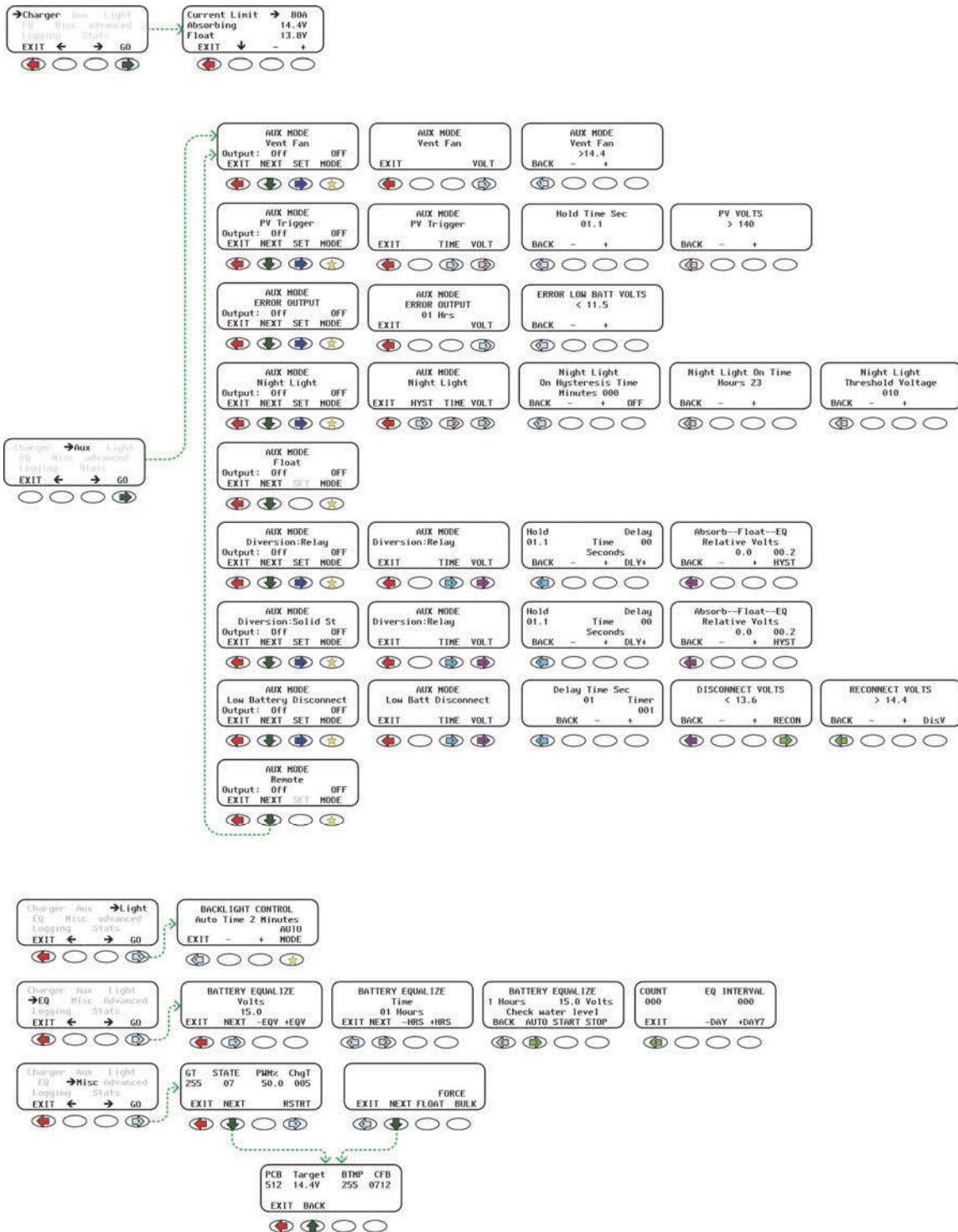

Figure 96 FLEXmax Menu Map (Page 1)

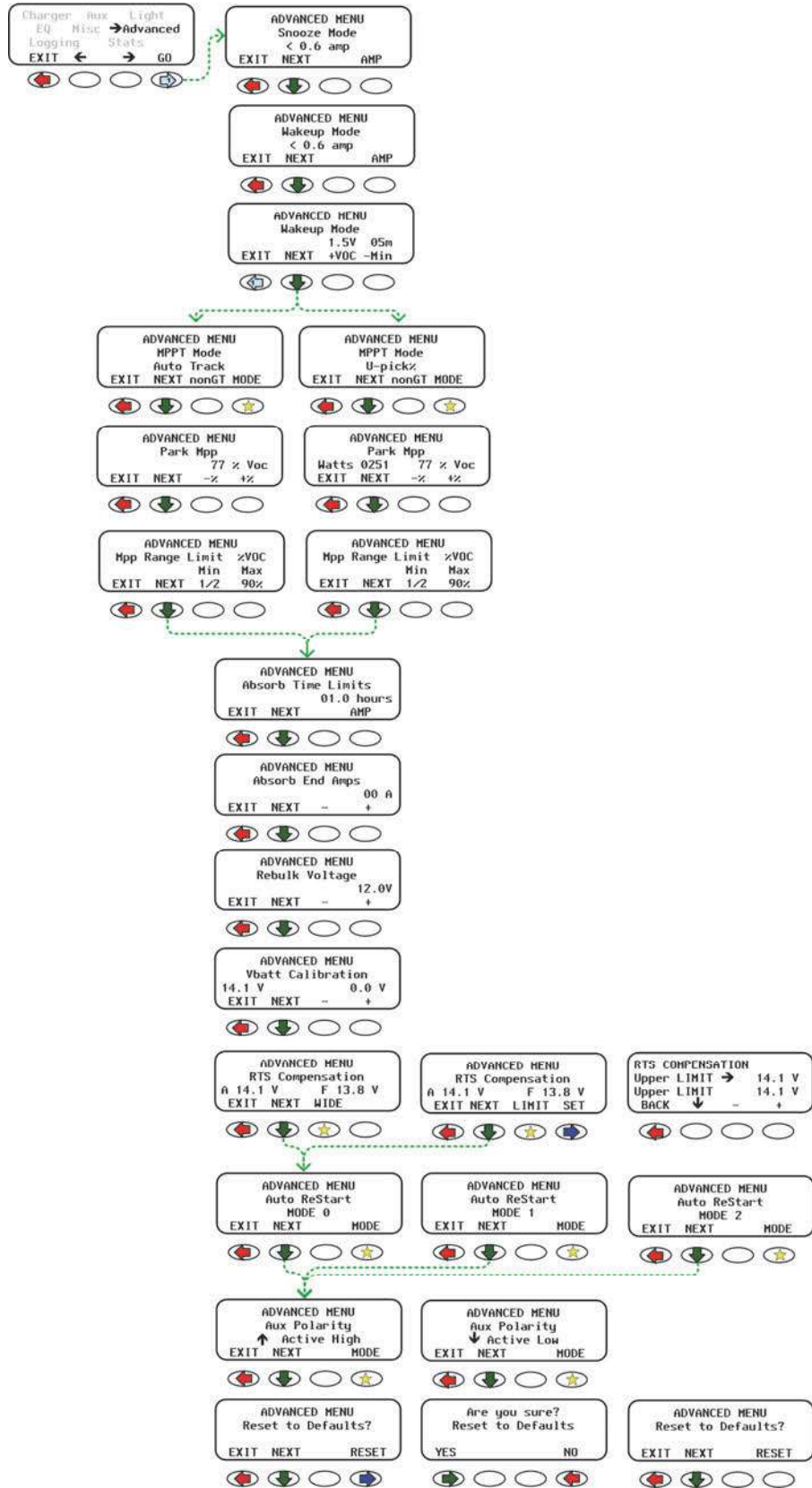

Figure 97 FLEXmax Menu Map (Page 2)

FLEXmax Menu Maps

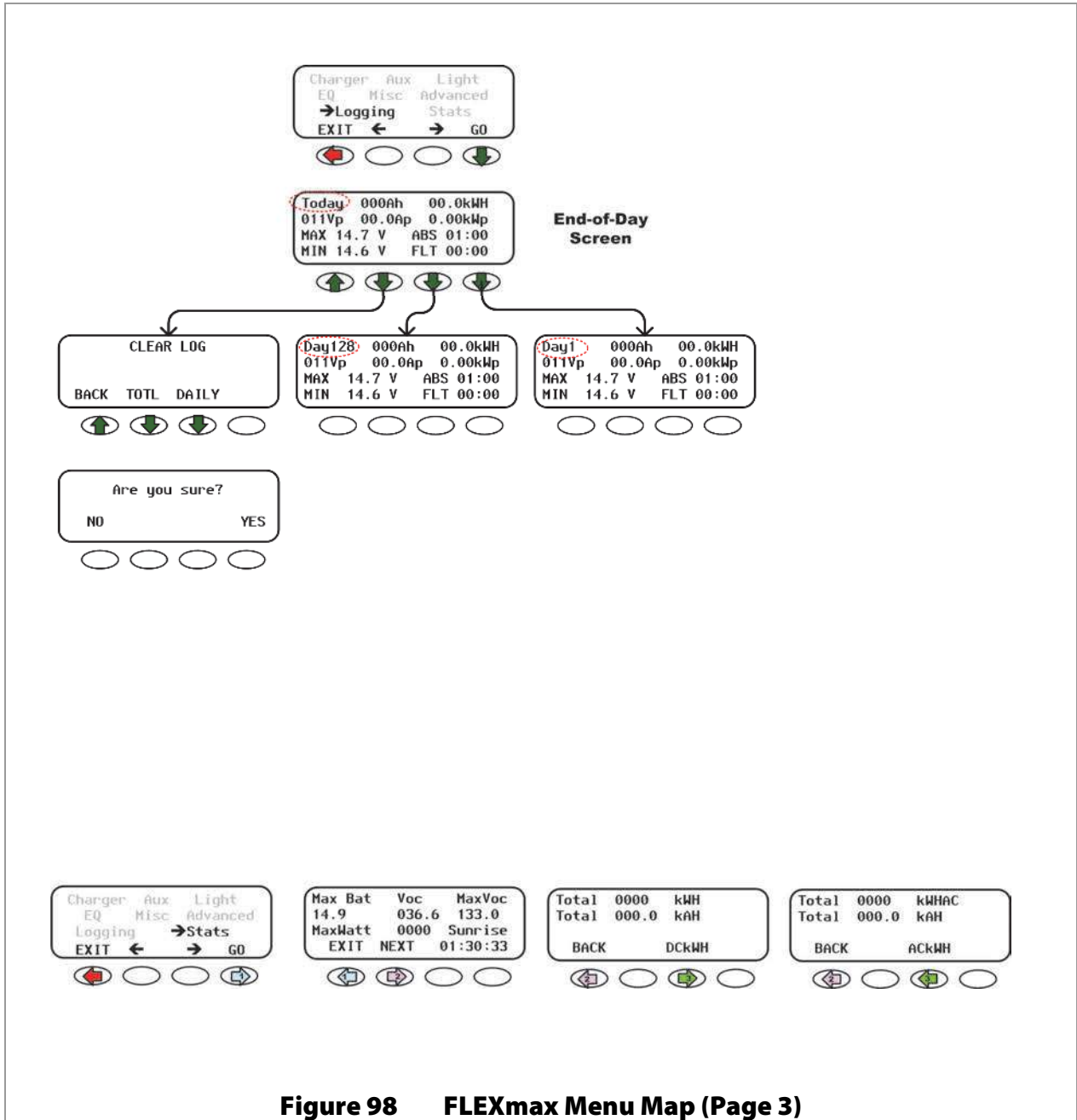

Figure 98 FLEXmax Menu Map (Page 3)



Troubleshooting



IMPORTANT:

Be sure to check out the OutBack customer and user forum at www.outbackpower.com/forum/ for more FLEXmax information.

Symptom	Remedy
FLEXmax does not boot/power-up (blank LCD)	<ul style="list-style-type: none"> ➤ Check the battery connection and polarity. Reverse polarity or an improper connection will cause power-up issues. ➤ Check the battery disconnect or circuit breaker. Ensure all circuit breakers are sized appropriately. ➤ Check the battery voltage at the FLEXmax terminals. A battery voltage below 10.5 Vdc may not power up the FLEXmax. A poor connection may not allow sufficient voltage to reach the FLEXmax.
FLEXmax not producing expected power	<ul style="list-style-type: none"> ➤ Check PV conditions. Clouds, partial shading, or dirty panels can cause poor performance. ➤ Check settings. The lower current limit set point in the <i>Charger</i> menu will yield a loss of power or poor performance symptoms. If the FLEXmax is in <i>U-Pick</i> mode, it may not track at the maximum power point. ➤ Check battery conditions and charging stage. If the batteries are charged (if the FLEXmax is in the Absorbing or Float stage), the FLEXmax will produce only enough power to regulate the voltage at the Absorbing or Float set point voltage. Less power is required during these stages. ➤ Determine the specified short-circuit current of the PV array. The MPP current is related to this number. Use a multimeter to determine if the short-circuit current is in the expected range. Array or wiring problems may restrict the available power. ➤ Check the PV array temperature. At high temperatures, the maximum power point voltage may be near or or lower than the battery voltage.
FLEXmax not equalizing	<ul style="list-style-type: none"> ➤ Make certain the equalization cycle has been started. <ul style="list-style-type: none"> ~ In the EQ menu, press START to begin the process. When the equalization cycle has been initiated, MPPT EQ will be displayed. ➤ The equalization cycle has been initiated, but the battery is not equalizing. <ul style="list-style-type: none"> ~ The cycle will begin when the target EQ set point voltage has been reached. A small array or cloudy weather will delay the EQ cycle. Running too many battery loads will also delay the cycle. ~ Check the PV array temperature. At high temperatures, the maximum power point voltage may be near or lower than the battery voltage. This can delay the cycle.

Troubleshooting

Symptom	Remedy
FLEXmax is always SLEEPING	<ul style="list-style-type: none"> ➤ Check battery voltage. If the battery voltage is at or above the Absorbing voltage set point (compensated for battery temperature), the FLEXmax will not wake up. ➤ Check PV voltage. The PV voltage has to be at least two volts greater than the battery voltage for the initial wakeup. ➤ If voltage is not present, check the PV array breaker (or fuse). Confirm the PV array breaker (or fuse) is sized appropriately.
PV voltage reads 000	<ul style="list-style-type: none"> ➤ If the PV array voltage on the display rises with the PV breaker OFF, but reads 000 with the PV circuit breaker on, the PV array polarity may be reversed or shorted. ➤ If the PV voltage still reads 000 with the PV circuit breaker off after a minute, call OutBack Technical Support for assistance.
Status screen shows BatTmpErr	<ul style="list-style-type: none"> ➤ Confirm the type of temperature sensor. Only the OutBack RTS (remote temperature sensor) can be used with the FLEXmax. ➤ If the RTS is correct, it may be faulty or damaged. Disconnect the RTS from the jack to resume normal operation. Replace the RTS as soon as possible.
FLEXmax internal fan not running	The internal fan will only run when the internal temperature has reached approximately 112°F. The fan will continue running until the internal temperature is less than 104°F.
FLEXmax makes a squealing sound	<p>If the MPP voltage is low enough to approach the battery voltage (usually when the array is very hot), it is near the effective limit of the MPPT function. This may cause the FLEXmax components to make a squealing noise. The problem can be alleviated by placing the FLEXmax in Extended Play, which extends the parameters of the MPPT sweep. See page 56 for instructions on using Extended Play.</p> <p>This mode may not be desirable under more standard conditions when the PV voltage is higher. The efficiency of the FLEXmax controller may be reduced.</p>
LCD display scrambled	Reboot the FLEXmax controller as described on page 57. This will clear any operating problems or glitches. It will also restore all programming items to their factory default settings.



Specifications

Electrical and Mechanical Specifications

Specification	FLEXmax 60	FLEXmax 80
Output Current Rating @ 40°C ambient	60 amps continuous	80 amps continuous
Nominal Battery System Voltage	12, 24, 36, 48 or 60 Vdc (adjustable)	
PV open circuit voltage	150 Vdc maximum (ETL Rating for UL1741 Standard); 145 Vdc temperature corrected Voc (operational maximum)	
Standby power consumption	Less than 1 watt typical	
Charge cycle	Three-stage	
Voltage regulation set points	13-80 Vdc	
Temperature compensation	5 mV per °C per 2 V cell (with optional RTS)	
PV input capability	Down convert from any acceptable array voltage to any battery voltage. Examples: 72 Vdc array to 24 Vdc battery; 60 Vdc array to 48 Vdc battery	
Digital Display	4-line, 20-character per line backlit LCD display	
Remote Interface	RJ45 modular connector Cat 5 cable 8 wire	
Operating Temperature Range*	-40° to 60°C (automatically derated above 40°C)	
Conduit knockouts	One 1" on the back; one 1" on the left side; two 1" on the bottom	
Warranty	Five years parts and labor	
Dimensions	13.5" H x 5.75" W x 4" D	16.25" H x 5.75" W x 4" D
Shipping Dimensions	18" H x 11" W x 8" D	21" H x 10.5" W x 9.75" D
Weight	11.6 lb (14 lb boxed)	12.20 lb (15.75 lb boxed)
Options	RTS, HUB 4, HUB 10, MATE, MATE2, MATE3	
Menu Languages	English and Spanish	

Firmware Revision

This manual applies to FLEXmax 80 or FLEXmax 60 charge controllers with a firmware revision of 002.001.xxx or higher.

Regulatory Specifications

Table 3 Regulatory Specifications for All Models

UL 1741 1st Edition; 2005 Version, CSA 107.1-01
CE Conformance European EN 55022 Class B

Default Settings and Ranges

Table 4 FLEXmax Settings

Mode	Menu Item	Setting	Mode	Menu Item	Setting
Charger	Current Limit (FLEXmax 80)	Default 80 Adc Range: 5 to 80 Adc	Aux (cont'd)	Low Battery Disconnect	Default <Off> <On, Auto, Off>
	Current Limit (FLEXmax 60)	Default 60 Adc Range: 5 to 60 Adc		Delay Time Sec	Default 01 second Range: 000 to 250 sec.
	Absorbing	Default 14.4 Vdc Range: Float setting to 80 Vdc		DISCONNECT VOLTS	Default 13.6 Vdc Range: 10 to 80 sec.
	Float	Default 13.8 Vdc Range: 12.0 Vdc to Absorbing setting		RECONNECT VOLTS	Default 14.4 Vdc Range: 10 to 80 sec.
				Remote	Default <Off> <On, Auto, Off>
Aux	Vent Fan	Default <Off> <On, Auto, Off>	Light	MODE	Default <AUTO> <ON, AUTO, OFF>
	Volts	Default 14.4 Vdc Range: 10.0 to 80.0 Vdc		Auto Time	Default 2 minutes Range: 1 to 9 minutes
	PV Trigger	Default <Off> <On, Auto, Off>	EQ	BATTERY EQUALIZE Volts	Default 14.4 Vdc Range: Absorbing setting to 80 Vdc
	Hold Time Sec	Default 01.1 second Range: 0 to 25 seconds		BATTERY EQUALIZE Time	Default 01 hours Range: 1 to 7 hours
	PV VOLTS	Default 140 Vdc Range: 20 to 150 Vdc		EQ INTERVAL	Default 000 days Range: 000 to 250 days
	ERROR OUTPUT	Default <Off> <On, Auto, Off>		Advanced	Snooze Mode
	ERROR LOW BAT VOLTS	Default 11.5 Vdc Range: 10 to 80 Vdc	Wakeup Mode Volts		Default 1.5 Vdc Range: 1.5 to 9.5 Vdc
	Night Light	Default <Off> <On, Auto, Off>	Wakeup Mode Time		Default 05 minutes Range: 05 to 15 min.
	ON Hysteresis Time (Minutes)	Default 001 minute Range: 001 to 255 min.	MPPT Mode		Default <Auto Track > <Auto Track or U-Pick>
	On Time (Hours)	Default 04 hours Range: 00 to 23 hours	Park Mpp		Default 77% Voc Range: 40 to 90% Voc
	Threshold Voltage	Default 010 Vdc Range: 005 to 150 Vdc	MPP Range Limit (Max)		Default <90%> <80, 85, 90, 99%>
	Float	Default <Off> <On, Auto, Off>	MPP Range Limit (Min)		Default <1/2> <1/2 or FULL>
	Diversion:Relay	Default <Off> <On, Auto, Off>	Absorb Time Limits		Default 01.0 hours Range: 00.0 to 24 hours
	Hold Time (Seconds)	Default 0.1 second Range: 0.0 to 25 sec.	Absorb End Amps		Default 00 Adc Range: 00 to 55 Adc
	Delay Time (Seconds)	Default 0.0 seconds Range: 0.0 to 24 sec.	Rebulk Voltage		Default 12.0 Vdc Range: 12.0 Vdc to Float setting
	Absorb-Float-EQ Relative Volts	Default 0.0 Vdc Range: 0.0 to 5.0 Vdc	Vbatt Calibration		Default 0.0 Vdc Range: -0.5 to 0.5 Vdc
	HYST	Default 00.2 Vdc Range: 0.0 to 12.0 Vdc	RTS Compensation Upper Limit		Default 14.1 Vdc Range: Lower Limit setting to 80 Vdc
	Diversion:Solid St	Default <Off> <On, Auto, Off>	RTS Compensation Lower Limit		Default 14.1 Vdc Range: 10 Vdc to Upper Limit setting
	Hold Time (Seconds)	Default 0.1 second Range: 0.0 to 25 sec.	Auto ReStart		Default <0> Selections <0, 1, 2>
	Delay Time (Seconds)	Default 00 seconds Range: 00 to 24 sec.	Aux Polarity		Default <Active High> <Active High or Low>
	Absorb-Float-EQ Relative Volts	Default 0.0 Vdc Range: 0.0 to 5.0 Vdc			
	HYST	Default 00.2 Vdc Range: 0.0 to 12.0 Vdc			



Applications

Maximum Power Point Tracking

Maximum Power Point Tracking (MPPT) is the technology used by FLEXmax controllers to optimize the harvest of power from PV arrays.

PV modules do not have a defined operating voltage. Their voltage is defined strictly by the load connected to them. With no load (disconnected), a module displays “open-circuit” voltage (V_{oc}), and delivers no current. At full load (shorted), a module has no voltage, although it delivers the maximum “short-circuit” current (I_{sc}). In neither case does it produce usable wattage.

When partially loaded, a PV module delivers partial current and voltage. These numbers can be multiplied to see the available wattage. However, the delivery of wattage is not linear. The current and voltage delivered at a given load will change with the load, along a curve such as that shown in the drawing to the left in Figure 99. This is known as the V-I curve. The wattage is different at every point along the curve. (The V-I curve also varies with module type and manufacturer.) Only one point on the V-I curve represents the delivery of the module’s maximum (rated) wattage. This is known as the maximum power point, or MPP. The current at this point, I_{mp} , is the highest that can be drawn while still maintaining the highest voltage, V_{mp} .

The FLEXmax controller places a variable load on the PV array and tracks the result to determine the maximum power point. This process, MPPT, is maintained so that the FLEXmax can deliver the maximum PV power regardless of any change in conditions. The drawing to the right in Figure 99 shows the MPP and compares the V-I curve against the available wattage.

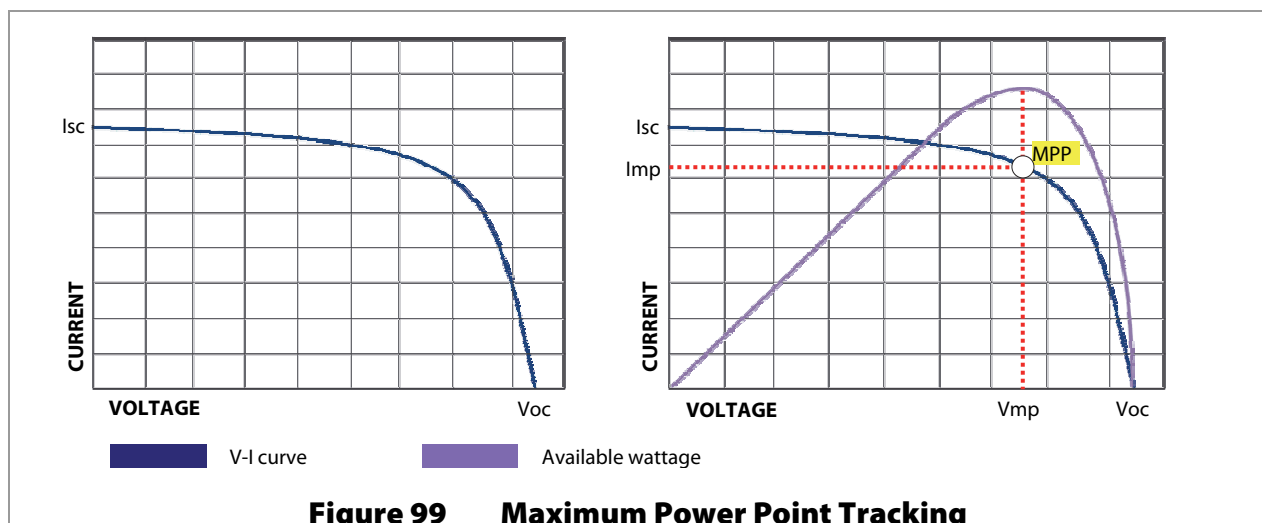

Three-Stage Battery Charging

The FLEXmax charge controller is a sophisticated, multi-stage battery charger that uses several regulation stages to allow fast recharging of the battery system while ensuring a long battery life. This process can be used with both sealed and non-sealed batteries. The FLEXmax is a “buck” converter which turns higher PV voltages into the lower charging voltages used by batteries (with correspondingly higher currents). The chart in Figure 100 shows the voltage levels achieved by the PV array throughout a typical day, and the battery voltages (by stage) during the same times.

The FLEXmax has preset recharging voltage set points (Absorbing and Float voltages); however, OutBack always recommends using the battery manufacturer’s recommended charging voltages.

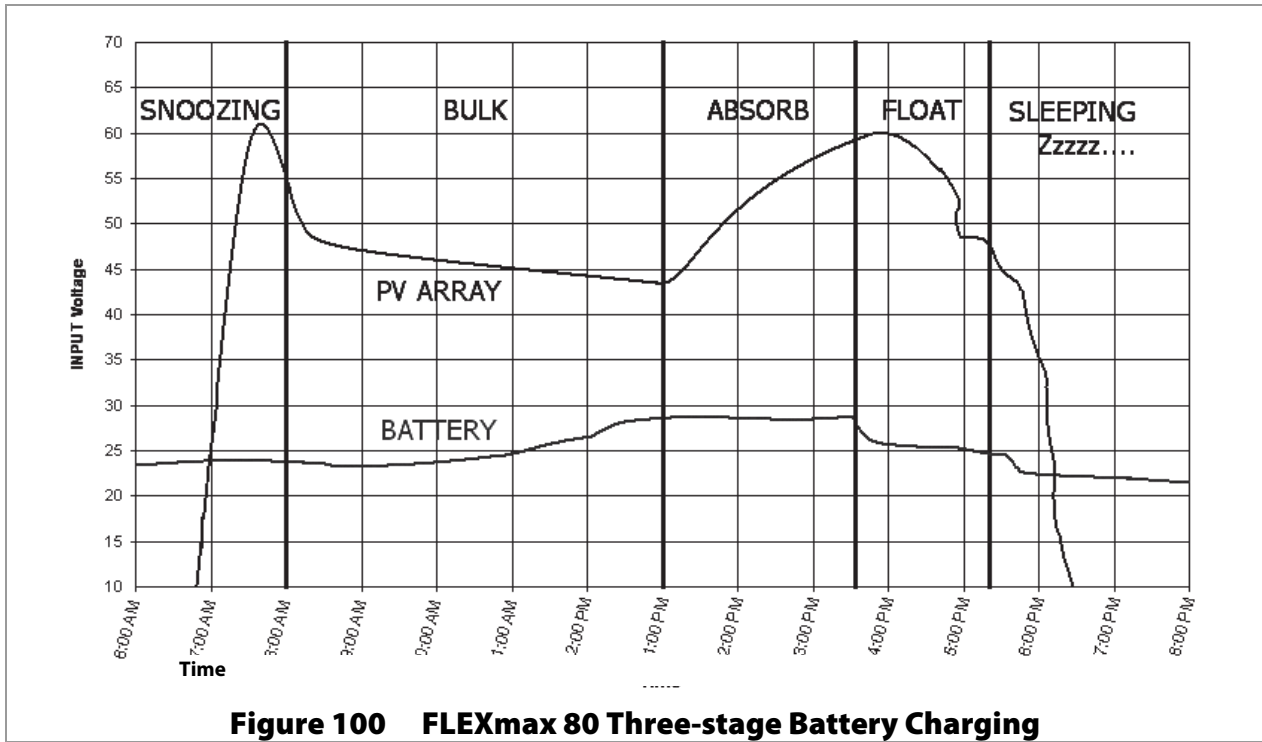

A new charge cycle is started any time the battery voltage decreases below the **Rebulk** set point . (See page 50.) This usually occurs each night unless the batteries were maintained by another means. (If so, they may not need to be recharged). See pages 20 through 24 for the messages displayed onscreen during the various stages.

BULK

This is the first stage in the three-stage charge cycle. It is a constant-current stage which drives the battery voltage up. The DC current is the maximum current the charger can deliver. This stage typically leaves the batteries at 75% to 90% of their capacity, depending on conditions.

In the Bulk stage, the FLEXmax will charge the batteries to the **Absorbing** voltage setting (see page 26). This stage is not timed. It will charge as long as necessary to complete the stage, regardless of any timer set points. If little PV energy is available, it may take a long time for this stage to complete. If the FLEXmax is in a different charging stage and little PV energy is available, it may return to Bulk. (See page 20.) This stage is temperature-compensated. (See page 97.)

ABSORBING

This is the second stage of charging. It is a constant-voltage stage. Current varies as needed to maintain the **Absorbing** voltage setting. However, it will typically decrease to a very low number over time. This “tops off the tank”, leaving the batteries at essentially 100% of capacity.

The duration of the Absorbing stage is the user-defined **Absorb Time Limit**. The **ChgT** timer is preset to zero following the previous charge cycle. Once in Absorbing, **ChgT** will count until it reaches this limit. (See pages 20, 44, and 48.) The charger will then exit Absorbing and enter the Float stage. The charger will also exit Absorbing if the **Absorb End Amps** setting is reached, regardless of the timer. This resets the timer to zero. (See page 44.) This stage is temperature compensated. (See page 97.)

FLOAT

When the charger enters this stage, it reduces the charging voltage to prevent overcharging of the batteries. The batteries are maintained at the **Float** set point. **Floating** is displayed on the screen. This stage is not timed. The FLEXmax will continue to maintain **Float** as long as PV energy is available.

If the PV cannot supply enough power to maintain the **Float** set point, the FLEXmax will not immediately initiate a new charge cycle. It will attempt to draw more PV energy and recharge the battery until the Float voltage set point is reached. When this occurs, **MPPT Float** is displayed (see page 22). This stage is temperature compensated. (See page 97.)

A new charge cycle can be initiated if the voltage falls below the **ReBulk** set point (see page 50).

Battery Temperature Compensation

Battery performance changes when the temperature varies above or below room temperature (77°F or 25°C). Temperature compensation is a process that adjusts charging to correct for these changes.

When a battery is cooler than room temperature, its internal resistance goes up and the voltage changes more quickly. This makes it easier for the charger to reach its voltage set points. However, while accomplishing this process, it will not deliver all the current that the battery requires. As a result, the battery will tend to be undercharged.

Conversely, when a battery is warmer than room temperature, its internal resistance goes down and the voltage changes more slowly. This makes it harder for the charger to reach its voltage set points. It will continue to deliver energy as time passes until the charging set points are reached. However, this tends to be far more than the battery requires, meaning it will tend to be overcharged.

The FLEXmax controller, when equipped with the Remote Temperature Sensor (RTS) will compensate for temperature. The RTS is attached to a single battery near the center of the bank. When charging, the RTS will increase or decrease the charge voltage by 5 mV per degree Celsius per battery cell. This setting affects the **Absorbing** and **Float** set points. Equalization is not compensated in the FLEXmax.

- In a 12 Vdc system (6 cells, 2 volts each), this means 0.03 volts per degree Celsius above or below 25°C. Maximum compensation is ± 0.6 Vdc.
- In a 24 Vdc system (12 cells, 2 volts each), this means 0.06 volts per degree Celsius above or below 25°C. Maximum compensation is ± 1.2 Vdc.
- In a 48 Vdc system (24 cells, 2 volts each), this means 0.12 volts per degree Celsius above or below 25°C. Maximum compensation is ± 2.4 Vdc.

Examples:

- A 12 Vdc system with 10°C batteries will compensate its charging to 0.45 Vdc **higher** than the set points.
- A 24 Vdc system with 35°C batteries will compensate its charging to 0.6 Vdc **lower** than the set points.
- A 48 Vdc system with 15°C batteries will compensate its charging to 1.2 Vdc **higher** than the set points.

Array Design

Sizing Guidelines

Below is a list of maximum array wattages for the FLEXmax for various nominal voltage batteries. This should be used for sizing an array. Note that every PV module is different. The specifications for every model should be consulted before designing or assembling a PV array.

Table 5 Maximum PV Input Wattage per Charge Controller¹

Nominal Battery Voltage	Maximum Array Size (in watts, Standard Test Conditions)	
	FLEXmax 80	FLEXmax 60
12 V	1000 W	800 W
24 V	2000 W	1600 W
36 V	3000 W	2400 W
48 V	4000 W	3200 W
60 V	5000 W	4000 W

Open Circuit Voltage (Voc)

Open-circuit voltage (Voc) is the *unloaded* voltage generated by the PV array. The FLEXmax controller can withstand Voc of up to 150 Vdc. However, if the Voc exceeds 145 Vdc, the FLEXmax will suspend operation to protect the system components.



CAUTION: Equipment Damage

Although the FLEXmax shuts down when voltage is greater than 145 Vdc, this will not prevent the array from generating voltage. Anything higher than 150 Vdc will damage the FLEXmax, whether it has shut down or not. The array should be designed so that voltage never exceeds 145 Vdc in order to prevent equipment damage.

Weather Conditions

Cooler climates can cause the Voc to rise above the array's rated Voc. In climates that observe temperatures less than approximately -15°C (5°F), a Voc greater than 125 Vdc is not recommended.

- Hot weather: lower Voc and lower Vmp
- Cold weather: higher Voc and higher Vmp

If the specific voltage temperature correction factor is not known for a particular module, allow for ambient temperature correction using the following information:

25° to 10°C (77° to 50°F)	multiply Voc by 1.06
9° to 0°C (49° to 32°F)	multiply Voc by 1.10
-1° to -10°C (31° to 14°F)	multiply Voc by 1.13
-11° to -20°C (13° to -4°F)	multiply Voc by 1.17
-21° to -40°C (-5° to -40°F)	multiply Voc by 1.25

¹ Based on the most common solar arrays under Standard Test Conditions (1000 watts per square meter to solar panel at 25°C [77°F]).

Maximum-Power Voltage (Vmp)

Maximum-power voltage (Vmp) is the operating voltage for the PV array at which the array generates the most wattage. When designing the PV array, it is recommended for the Vmp to be approximately 12 to 24 volts higher than the nominal battery voltage for optimum performance. This will ensure that the Vmp is always above the battery voltage, which is required for charging. Higher voltages are not recommended, as they may reduce the FLEXmax conversion efficiency.



IMPORTANT:

Check the PV array voltage before connecting it to the FLEXmax.

Standard vs. Australian Default Settings

Several version settings are available for the FLEXmax upon initial setup. These can be selected upon initial power-up. (See page 15.) The English and Spanish versions have the same standard default settings; however, the Australian version has certain default settings that are different. However, there are no differences in performance and efficiency between the two versions. The standard and Australian version can be identified as follows:

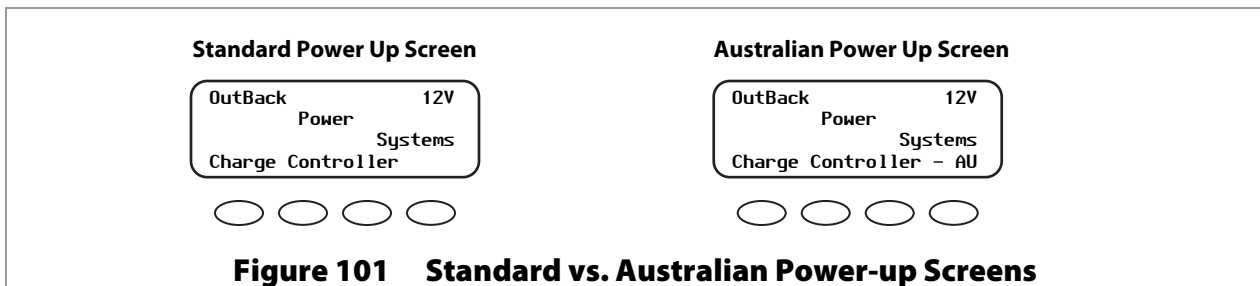

Figure 101 Standard vs. Australian Power-up Screens

Table 6 Default Settings Standard vs. Australian

Settings	Standard		Australian	
	Absorbing	Float	Absorbing	Float
12 V	14.4 V	13.6 V	14.4 V	13.8 V
24 V	28.8 V	27.2 V	28.8 V	27.6 V
36 V	43.2 V	40.8 V	43.2 V	41.4 V
48 V	57.6 V	54.4 V	57.6 V	55.2 V
60 V	72.0 V	68.0 V	72.0 V	69.0 V
Equalize	Equalize Volts		Equalize Volts	
12 V	14.4 V		14.7 V	
24 V	28.8 V		29.4 V	
36 V	43.2 V		44.1 V	
48 V	57.6 V		58.8 V	
60 V	72.0 V		73.5 V	
Equalize Time	01 Hours		03 Hours	

Hydroelectric and Fuel Cell Applications

Performance Optimization

The FLEXmax Charge Controller is designed to work with PV arrays. Although it will work with hydroelectric turbines and fuel cells, OutBack Power Technologies can only offer limited technical support for these applications due to variance in turbine and fuel cell specifications.



IMPORTANT:

The FLEXmax Charge Controller is not usable for direct regulation of wind turbine input and OutBack cannot warranty its use in these applications. In wind turbine applications, the FLEXmax is recommended as a diversion controller. (See page 35.)

The FLEXmax maximum power point tracking (MPPT) function can be set to **Auto Track** or **U-Pick%** mode as described on page 48. The MPPT function is based on the open-circuit voltage (Voc) of the DC source. This is the unloaded voltage displayed by the source when it is disconnected. MPPT values are expressed as a percentage of Voc. **Auto Track** mode allows the FLEXmax to sweep the range of percentages. The **Auto Track** mode begins at the maximum value and loads the array, working its way through lower voltages, until it locates the input voltage that yields maximum wattage.

Auto Track Mode

The default minimum value of **Auto Track** is **1/2** (50% of Voc). The default maximum is 90% of Voc. This is the standard maximum-power range for PV. A hydroelectric or fuel-cell system's operating voltage may operate in a different range and often have a maximum-power voltage close to the battery voltage. The FLEXmax allows a user to set a sweep range more appropriate for the source. The minimum setting can be changed to **FULL**, which is 40% of the Voc. The maximum value can be set from 80% to 99% of Voc if necessary.

This adjustment only affects the initial tracking at the beginning of the day and any subsequent trackings caused by **Auto-Restart** or any forced restart of the FLEXmax.

U-Pick Mode

If an optimal voltage is known for a given DC source, then this voltage can be set as a designated Voc percentage in **U-Pick%** mode. This percentage is assigned in the **Park Mpp** set point, which allows a range of 40% to 99% of Voc. If **U-Pick % Voc** is chosen, the FLEXmax will load the source to operate continuously at the designated voltage. It will not sweep for the maximum power point and will ignore all **Auto Track** values.

Main Menu

→Charger Aux Light
 EQ Misc Advanced
 Logging Stats
 EXIT ← → GO



ADV SETUP Screen

Charger Aux Light
 EQ Misc →Advanced
 Logging Stats
 EXIT ← → GO



ADVANCED MENU

Snooze Mode
 < 0.6 amp
 EXIT NEXT AMP



Mpp Range Limit % Voc

ADVANCED MENU
 Mpp Range Limit %VOC
 Min Max
 EXIT NEXT 1/2 90%



MPPT Mode (Auto Track)

ADVANCED MENU
 MPPT Mode
 Auto Track
 EXIT NEXT nonGT MODE



U-pick% (Voc) MPPT

ADVANCED MENU
 Park Mpp
 Watts 0251 77 % Voc
 EXIT NEXT -% +%



To adjust the Lower Mpp Range Limit:

1. From the main menu, press <→> to move the arrow next to the **Advanced** function.
2. Press <GO>.
3. In the **ADVANCED MENU** screen, press <NEXT> again to display the **Mpp Range Limit % Voc** screen.
4. Press <1/2> until **FULL** appears.
5. When finished, press <NEXT> until the **MPPT Mode** screen appears.

To pick between **Auto Track** or **U-Pick % MPPT** Mode and determine the charge controller's operating Voc percentage, press <MODE> to interchange between the two modes.

Re-entering the password might be required. After choosing a mode, press <NEXT> in the **ADVANCED MENU** to view the **Park Mpp** screen (only applicable for **U-Pick** mode).

Press <-%> or <+%> to select one of the percentage values; **U-Pick** always uses the **Park Mpp** value.

Figure 102 Adjusting Range Limits for Hydroelectric or Fuel-cell Applications

Grid-Interactive Settings

When using an OutBack inverter, FLEXmax, HUB, and system display, set the FLEXmax to **GT** in the Advanced menu. GT mode allows the inverter to manage the FLEXmax Float setting. It ensures the FLEXmax always keeps the battery above the sell voltage of the inverter. (See page 48.)

When using a FLEXmax charge controller with an inverter without the use of a HUB, GT mode will not work because the FLEXmax cannot communicate with the inverter. In this situation, when selling electricity back to the grid, keep the inverter's "sell" voltage setting below the FLEXmax Float setting. In a 24-volt battery system, the difference should be at least 0.5 Vdc. In a 48-volt system, the difference should be at least 1.0 Vdc.

Charge Controller Efficiency vs. Input Power

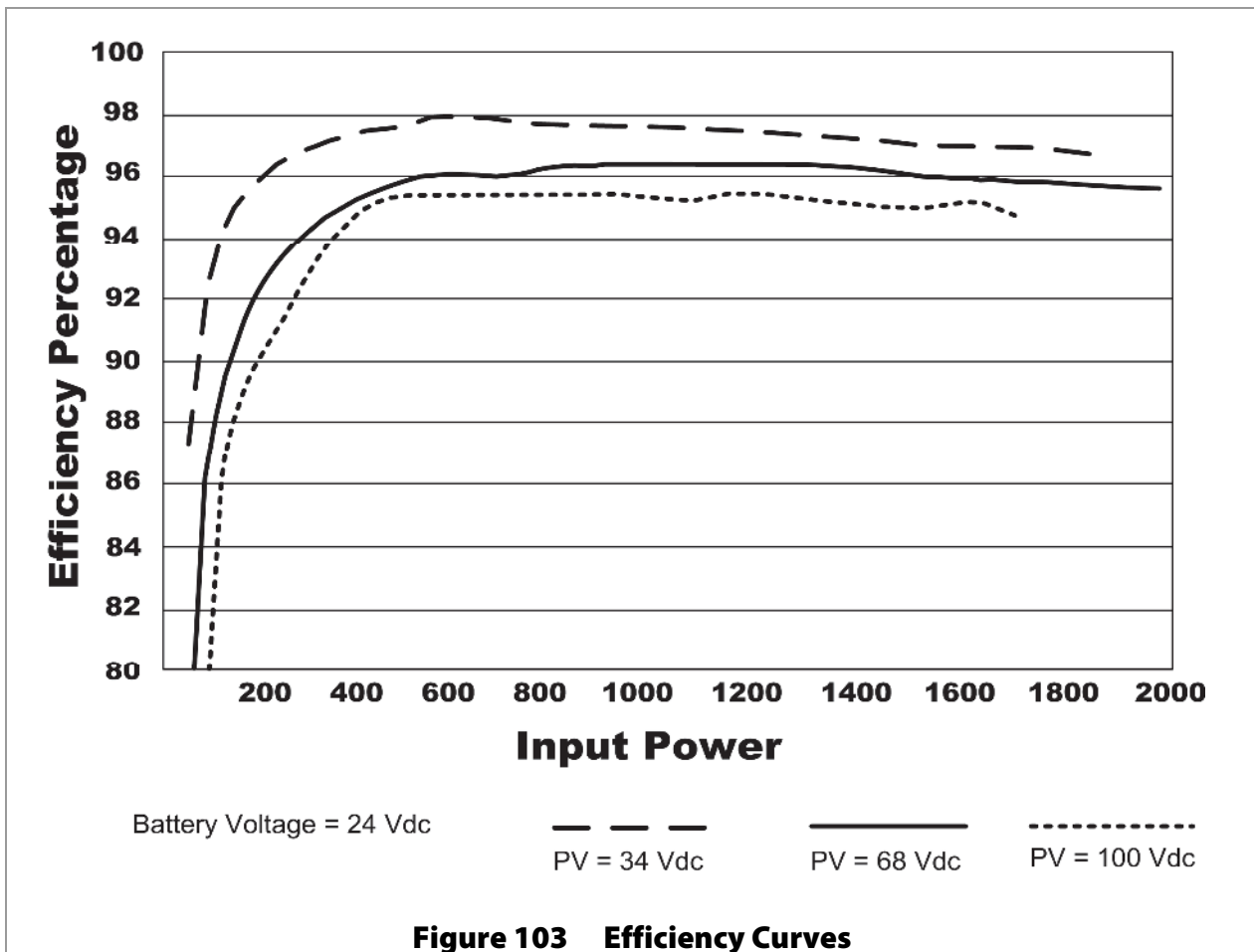

Definitions

The following is a list of initials, terms, and definitions used with this product.

Table 7 Terms and Definitions

Term	Definition
AC	Alternating Current; refers to voltage produced by the inverter, utility grid, or generator
AGS	Advanced Generator Start
AUX	Inverter's 12-volt auxiliary output
CE	Conformité Européenne; French for "European Conformity"; a marking on OutBack products indicating that they meet European Union requirements
DC	Direct Current; refers to voltage produced by the batteries or renewable source
DVM	Digital Voltmeter
FN-DC	FLEXnet DC; the OutBack Battery Monitor
Grid-interactive, grid-tie	Utility grid power is available for use and the system is capable of returning (selling) electricity back to the utility grid.
Ground Fault	An unsafe condition of current flow to ground, resulting from accidental contact between an electrical source and ground
I_{mp}	Maximum-power current; the current harvested by MPPT when operating at the V_{mp}
I_{sc}	Short-circuit current; the fully-loaded current displayed by a PV module or array
LED	Light-Emitting Diode; refers to indicators used by the inverter and the system display
MPP, MPPT	Maximum Power Point, Maximum Power Point Tracking
Negative-Ground	A wiring system that bonds the negative conductor to ground for safety
Positive-Ground	A wiring system that bonds the positive conductor to ground for safety
PWM	Pulse-Width Modulation
PV	Photovoltaic
RTS	Remote Temperature Sensor; accessory that measures battery temperature for charging
SK	Soft Key; a key with programming that varies with screen
System display	Remote interface device (such as the MATE, MATE2, or MATE3), used for monitoring, programming and communicating with the inverter; also called "remote system display"
V_{mp}	Maximum-power voltage; voltage sought by MPPT where maximum power is harvested
V_{oc}	Open-circuit voltage; the unloaded voltage displayed by a PV module or array

THIS PAGE INTENTIONALLY LEFT BLANK.



Index

A

Absorb End Amps.....	49
Absorb Time Limits.....	49
Absorbing.....	20, 97
Advanced Menu.....	46
Absorb End Amps.....	49
Absorb Time Limits.....	49
Auto ReStart.....	52
AUX Polarity.....	53
Logging.....	54
MPPT Mode.....	47
Rebulk Voltage.....	50
Reset to Defaults.....	53
RTS Compensation.....	50
Snooze.....	46
Stats.....	55
Vbatt Calibration.....	50
Wakeup Mode.....	47
AGS.....	See Automatic Generator Start
Applications.....	95
Array Design.....	98
Australian Settings.....	99
Auto ReStart.....	21, 52, 67
Auto Track.....	47
Automatic Generator Start (AGS).....	41, 103
AUX.....	103
AUX Modes.....	27, 66
Diversion.....	35
Error Output.....	32
Float.....	34
Low Battery Disconnect.....	40
Night Light.....	33
PV Trigger.....	31
Remote.....	41
Vent Fan.....	30
AUX Polarity.....	53
AUX Terminals.....	11

B

Backlight.....	41
Battery Charging.....	26, 64, 74, 78, 96
Battery Voltage.....	15, 16
Bulk.....	22, 96

C

Calibration.....	50, 68
------------------	--------

Charger Setup.....	26, 64, 78
Contact Information.....	2

D

Data Logging.....	19, 54, 61, 69, 75
Default Settings.....	94, 99
Defaults.....	68
Defaults.....	15, 53, 57
Definitions.....	103
Diagrams.....	12, 13, 14, 39
Dimensions.....	8
Diversion.....	
Relay.....	35
Solid St.....	37

E

Efficiency.....	102
End-of-Day Summary Screen.....	18
Equalizing.....	21, 23, 42, 65
Extended Play.....	56, 92

F

Features.....	5, 6
Firmware Revision.....	5, 56, 93
FLEXware.....	9
Float.....	22, 97
Fuel Cell Applications.....	100, 101

G

Graph Screens.....	62
Grid-Tie.....	22, 44, 48, 65, 102, 103
Grounding.....	7, 11
GT Mode.....	22, 44, 48, 65, 102

H

Hydroelectric Applications.....	100, 101
---------------------------------	----------

I

Initial Operation.....	24
Installation.....	7
Introduction.....	5

Applications

L

Language.....	15, 16
Logging.....	19, 54, 69, 75

M

Main Menu.....	15, 24
MATE or MATE2	
Advanced Menus.....	77
AUX.....	81
CC ADV.....	79
CHRG.....	78
EQ.....	80
Menu Map.....	84
CC ADV Menu Map.....	84, 85
CC STATUS Menu Map.....	82, 83
Password.....	77
Status Screens.....	72
CC LOG.....	75
CC SETPT.....	74
CC STAT.....	76
Menu Map.....	82
Meter.....	73
Mode.....	72
Summary Screens.....	71
MATE3	
Auxiliary Output.....	66
Calibrate.....	68
Charger Settings.....	64
Device Data Logs.....	69
Equalization.....	65
Grid-Tie Mode.....	65
Menu Structure.....	63
MPPT.....	64
Password.....	63
Restart Mode.....	67
Screens.....	59
Temperature Compensation.....	65
Maximum Power Point Tracking.....	47, 95
Maximum PV Wattage.....	98
Maximum-Power Voltage.....	95, 99
Menu Maps.....	25
FLEXmax.....	87, 88, 89, 90
MATE or MATE2.....	82, 83, 84, 85
MATE3.....	63
Misc Screen.....	44
Modes.....	20
Absorbing.....	20
AutoRestart.....	21, 52, 67
AutoStart.....	21, 67
BatTmpErr.....	21, 92
BatTooHot.....	21
Charged.....	21
EQ.....	21
EQ Done.....	21
EX Absorb.....	22
Floating.....	22
GT Mode.....	22, 65

High Voc.....	22
Low Light.....	22
MPPT Bulk.....	22
MPPT EQ.....	23
MPPT Float.....	22
New Voc.....	23
Over Temp.....	23
OvrCurrent.....	23
Re-Cal.....	23
Sleeping.....	23, 92
Snoozing.....	22
Sys Error.....	23
Tracking.....	23
Unloaded.....	24
Wakeup.....	24
Zzzzz.....	24
Modes.....	60
Mounting.....	9
MPPT.....	47, 95, 103

O

Open-Circuit Voltage.....	95, 98
Operation.....	15

P

Password.....	15, 63, 77
Photovoltaic.....	103
Ports.....	11
Powering Up.....	15
PV Design.....	98

R

Rebooting the FLEXmax.....	57
Rebulk Voltage.....	50
Remote Temperature Sensor.....	11, 50, 65, 103
Reset to Defaults.....	15, 53, 57, 68
RTS.....	See Remote Temperature Sensor

S

Settings.....	24
SK See Soft Keys	
Snooze Mode.....	46
Soft Keys.....	6, 103
Specifications.....	93
Standard vs. Australian Default Settings.....	99
STATS Menu.....	55, 76
Status Screen.....	17, 20
System Display.....	103
MATE or MATE2.....	71
MATE3.....	59

T

Temperature.....	23, 45, 50, 65, 97, 98
Terminals.....	11

Three-Stage Battery Charging	96
Timers	
Float (reading)	61
Troubleshooting	91

U

U-Pick	47
--------------	----

V

Vbatt Calibration	50, 68
Vmp	95, 99
Voc	95, 98

W

Wakeup Mode	47
Weather Conditions	98
Wiring	7, 10, 11, 12, 13, 14, 39

THIS PAGE INTENTIONALLY LEFT BLANK.

THIS PAGE INTENTIONALLY LEFT BLANK.



Corporate Headquarters
17825 – 59th Avenue N.E.
Suite B
Arlington, WA 98223 USA
+1.360.435.6030

European Office
Hansastraße 8
D-91126
Schwabach, Germany
+49.9122.79889.0