



Sonali Energies USA LLC.,
111 Charlotte Place, Suite #101,
Englewood Cliffs, NJ 07632, USA
Tel: 201-568-1424
salesusa@sonalisolar.com

Installation Guide For SONALISOLARUSA Photovoltaic Panel



Sonali Energies USA LLC.,
111 Charlotte Place, Suite #101,
Englewood Cliffs, NJ 07632, USA
Tel: 201-568-1424
salesusa@sonalisolar.com

TABLE OF CONTENT

1 - Purpose of this guide	03
○ General safety	03
○ Handling safety	04
○ Installation safety	05
○ Fire safety	06
2 - Product Identification	07
3 - Mechanical Installation	07
○ Selecting the location	07
○ General Installation	08
○ Installation methods	09
○ Attachment guidelines	10
4 - Electrical Installation	15
○ General installation	15
○ Grounding	16
○ Series and Parallel Connections	17
5 - Maintenance	19
6 - Dimensions &Parameters	19



Sonali Energies USA LLC.,
111 Charlotte Place, Suite #101,
Englewood Cliffs, NJ 07632, USA
Tel: 201-568-1424
salesusa@sonalisolar.com

1. PURPOSE OF THIS GUIDE

- This is guide contains information regarding the installation and safe handling of SONALI ENERGIES USA LLC , photovoltaic module (hereafter referred to as “module”). SONALI ENERGIES USA LLC referred to as “SONALISOLARUSA”.
- Installers must read and understand this guide prior to installation. For any questions, please contact our Global Quality & Customer Support department for further information. Installers should follow all safety precautions described in this guide as well as local codes when installing a module.
- Before installing a solar photovoltaic system, installers should familiarize themselves with its mechanical and electrical requirements. Keep this guide in a safe place for future reference (care and maintenance) and in case of sale or disposal of the modules.

● GENERAL SAFETY

- Modules that fall under this application class may be used in system operating at more than 50V DC or 240W, where general contact access is anticipated. The module is considered to be in compliance with IEC61215&61730 only when the modules mounted in the manner specified by the mounting instructions below.
- A module with exposed conductive parts is considered in compliance with IEC61215&61730 only when it is electrically grounded in accordance with the instructions presented below and the requirements of the National Electrical Code.
- Installing solar photovoltaic systems requires specialized skills and knowledge. Installation should only be performed by qualified persons.
- Installers should assume all risks of injury that might occur during installation, including, but not limited to, the risk of electric shock.
- One single module may generate more than 30V DC when exposed to direct sunlight. Contact with a DC voltage of 30V or more is potentially hazardous.
- Do not disconnect under load.



Sonali Energies USA LLC.,
111 Charlotte Place, Suite #101,
Englewood Cliffs, NJ 07632, USA
Tel: 201-568-1424
salesusa@sonalisolar.com

- Photovoltaic solar modules convert light energy to direct current electrical energy. They redesigned for outdoor use. Modules can be ground mounted, mounted on rooftops, vehicles or boats. The proper design of support structures lies within responsibility of the system designers and installers.
- Do not use mirrors or other magnifiers to concentrate sunlight onto the modules.
- When installing the system, abide to all local, regional and national statutory regulations. Obtain a building permit if necessary.
- This product must be installed by a licensed electrician in accordance with the applicable electrical code (i.e. the NEC for the USA and CEC for Canada).
- The electrical characteristics are under standard test conditions (irradiance of 100 mW/cm², AM 1.5 spectrum, and a cell temperature of 25°C (77°F)).
- Only use equipment, connectors, wiring and support frames suitable for solar electric systems.

- **HANDLING SAFETY**

- Do not lift the module by grasping the module's junction box or electrical leads.
- Do not stand or step on the module.
- Do not drop the module or allow objects to fall on the module.
- To avoid glass breakage, do not place any heavy objects on the module.
- Be cautious when setting the module down on to a surface.
- Inappropriate transport and installation may break the module.
- Do not attempt to disassemble the modules, and do not remove any attached nameplates or components from the modules.
- Do not apply paint or adhesive to the module top surface.
- To avoid damage to the back sheet, do not scratch or hit the backsheet.
- Do not drill holes in the frame. This may compromise the frame strength and cause corrosion of the frame.
- Do not scratch the anodized coating of the frame (except for grounding connection). It may cause corrosion of the frame or compromise the frame strength.
- Be careful when setting the panel down onto a surface, particularly when placing it on a corner.



Sonali Energies USA LLC.,
111 Charlotte Place, Suite #101,
Englewood Cliffs, NJ 07632, USA
Tel: 201-568-1424
salesusa@sonalisolar.com

- A panel with broken glass or torn back sheet cannot be repaired and must not be used since contact with any panel surface or the frame can cause an electric shock.
- Work only under dry conditions and use only dry tools. Do not handle panels when they are wet unless wearing appropriate protective equipment.
- When storing uninstalled panels outdoors for any period of time, always cover the panels and ensure that the glass faces down to stop water from collecting inside the panel and causing damage to exposed connectors.

- **INSTALLATION SAFETY**

- Any module without a frame (laminated) shall not be considered to comply with the requirements of IEC61215&61730 unless the module is mounted with hardware that has been tested and evaluated with the module under this standard or by a field inspection certifying that the installed module complies with the requirements of IEC61215&61730.
- Never open electrical connections or unplug connectors while the circuit is under load. And do not disconnect during load connection for a removable connector.
- Contact with electrically charged parts of the panels, such as terminals, can result in burns, sparks and lethal shock whether the panel is connected.
- Do not touch the PV module unnecessarily during installation. The glass surface and the frame maybe hot; there is a risk of burns and electric shock.
- Do not work in the rain, snow or in windy conditions.
- Avoid exposing cables to direct sunlight in order to prevent their degradation.
- Keep children well away from the system while transporting and installing mechanical and electrical components.
- Do not expose the artificially sunlight to a module or panel. And completely cover the module with an opaque material during installation to prevent electricity from being generated.
- Do not wear metallic rings, watchbands, ear, nose, lip rings or other metallic objects while installing or troubleshooting photovoltaic systems.
- Use only insulated tools that are approved for working on electrical installations.



Sonali Energies USA LLC.,
111 Charlotte Place, Suite #101,
Englewood Cliffs, NJ 07632, USA
Tel: 201-568-1424
salesusa@sonalisolar.com

- Follow the safety regulations for all other system components, including wires and cables, connectors, charging regulators, inverters, storage batteries, rechargeable batteries, etc.
- Under normal outdoor conditions the current and voltage generated by the system will differ from those listed on the datasheet. Datasheet values are the values measured under standard test conditions. Accordingly, during system designing phase, current and short-circuit current should be multiplied by a factor of 1.25 to determine components ratings.
- Only use connectors to connect modules to form a string or connect to another device. Removing the connectors will make the warranty void.

- **FIRE SAFETY**

- The fire rating of this module is valid only when mounted in the manner specified in the mechanical mounting instructions.
- The fire rating of the module can be referred to UL61730 is Class C/Type 1.
- Consult your local authority for guidelines and requirements for building or structural fire safety.
- Roof constructions and installations may affect the fire safety of a building; improper installation may create hazards in the event of a fire.
- Use components such as ground fault circuit breakers and fuses as required by local authority.
- Do not use panels near equipment or in places where flammable gases may be generated.
- Do not use non-integral module and panel are installed on a roof that has fire danger. If a non-integral module and panel are installed on a roof that must has fire-resistant degree of class A.
- The safe distance between the module and the roof we suggest is 20~30centimeters.

2. PRODUCT IDENTIFICATION

Each module has two labels providing the following information:

1. **Nameplate:** describes the product type; rated power, rated current, rated voltage, open circuit voltage, short circuit current, all as measured under standard test conditions; weight, dimensions etc.; the maximum system voltage of 1500 volts DC.
2. **Barcode:** each individual module has a unique serial number. The serial number has 14 digits. It includes Series, Manufacturer, Wattages, type, year and month, batch/serial number. Each module has only one barcode. It is permanently attached to the interior of the module and is visible from the front of the module. This bar code is inserted prior to laminating.

Rule for Serial number for SS series



SS10HQSDE00001

Do not remove any labels. Removing a label will make the SONALISOLARUSA warranty void.

3. MECHANICAL INSTALLATION

• SELECTING THE LOCATION

- Select a suitable location for installing the modules.
- The suitable altitude for installing is below 2000 meters.
- The modules should be facing south in northern latitudes and north in southern latitudes.
- For detailed information on the best installation angle, refer to standard solar photovoltaic installation guides or consult a reputable solar installer or systems integrator.
- The module should not be shaded at any time.
- Do not use modules near equipment or in locations where flammable gases may be generated or collected.



Sonali Energies USA LLC.,
111 Charlotte Place, Suite #101,
Englewood Cliffs, NJ 07632, USA
Tel: 201-568-1424
salesusa@sonalisolar.com

- **GENERAL INSTALLATION**

- The module mounting structure must be made of durable, corrosion-resistant and UV-resistant material.
- In regions with heavy snowfall in winter, select the height of the mounting system so that the lowest edge of the module is not covered by snow for any length of time.
- In addition, ensure that the lowest portion of the module is placed high enough so that it is not shaded by plants or trees or damaged by flying sand.
- Modules must be securely attached to the mounting structure.
- Provide adequate ventilation under the modules in conformity to your local regulations. A minimum distance of 10 cm between the roof plane and the frame of the module is generally recommended.
- Always observe the instructions and safety precautions included with the module support frames.
- Do not attempt to drill holes in the glass surface of the modules as this will void the warranty.
- Do not drill additional mounting holes in the module frames of the modules as this will void the warranty.
- Before installing modules on a roof, ensure that the roof construction is suitable. In addition, any roof penetration required to mount the module must be properly sealed to prevent leaks.
- When installing a module on a pole, choose a pole and module mounting structure that will withstand the anticipated winds for the area.
- Dust building up on the surface of the module can impair with module performance. SONALISOLARUSA recommend installing the modules with a tilt angle of at least 10 degrees, making it easier for dust to be washed off by rain.
- Observe the linear thermal expansion of the module frames (the recommended minimum distance between two modules is 2 cm).
- Always keep the back sheet of the panel free from foreign objects or structural elements, which could come into contact with the panel, especially when the panel is under mechanical load.



Sonali Energies USA LLC.,
111 Charlotte Place, Suite #101,
Englewood Cliffs, NJ 07632, USA
Tel: 201-568-1424
salesusa@sonalisolar.com

- Ensure panels are not subjected to wind or snow loads exceeding the maximum permissible loads and are not subject to excessive forces due to the thermal expansion of the support structures: See the following paragraph for more detailed information.

- **INSTALLATION METHODS**

- Common hardware items such as nuts, bolts, star washers, lock washers and the like have not been evaluated for electrical conductivity or for use as grounding devices and should be used only for maintaining mechanical connections and holding electrical grounding devices in the proper position for electrical conductivity. Such devices, where supplied with the module and evaluated through the requirements in UL 1703, may be used for grounding connections in accordance with the instructions provided with the module.
- We suggest each module be securely fastened at 8 points (14mm×9mm). Modules must be installed according to the following examples. Not mounting the modules according to these instructions may void the warranty.
- For our modules, designed mechanical load of front face is 3600Pa and safety factor is 1.5; designed mechanical load of back face is 1600Pa and safety factor is 1.5.
- Module can be installed in both landscape and portrait modes.
- For best performance, separate laying of positive and negative cables wherever possible. Induced voltage surges in the DC main cable should be minimized by laying the positive and negative cables as close together as possible.
- Where this is not possible or not desirable, the inverter energy system should be connected to the distribution board located physically nearest to the inverter, and the main switchboard. And main switch for the switchboard, to which the inverter is connected, shall be a lockable switch.
- The modules must be properly secured to their support so that they can withstand live load conditions, including wind uplift, to the pressure they have been certified for. It is the installer's responsibility to ensure that the clamps used to secure the modules are strong enough.

- **ATTACHMENT GUIDELINES**

- **SCREW INSTALLATION**

Each PV module has 8 mounting holes (shown as drawing 1). The downward mechanical load resistance of module would be different according to the installation holes used (shown as table 1), Please use 8 of them to secure the modules to support structure. The module frame must be attached to a mounting rail using M8 corrosion-proof screws together with spring washers and flat washers in eight symmetrical locations on the PV module. The applied torque should be big enough to fix it steadily. The reference torque value for M8 screw is 16~20N*m.

5400 Pa Load Tested	
Mounting System	

Table 1



Drawing 1

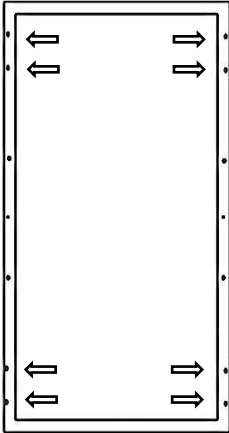
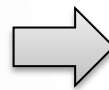
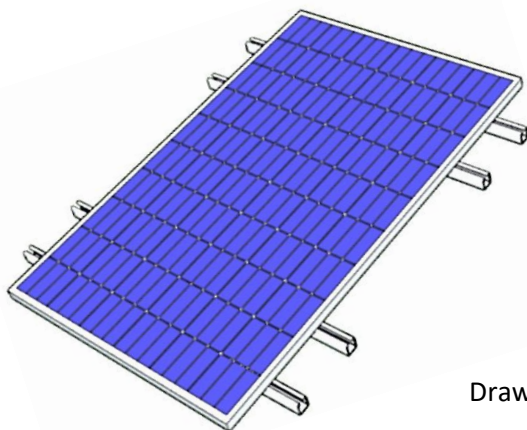
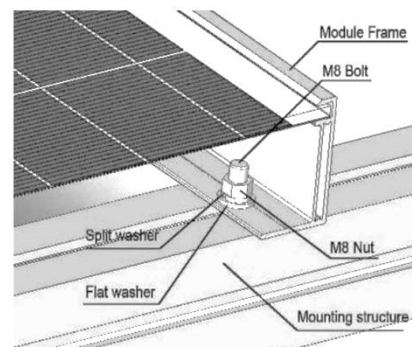

○ **CLAMP INSTALLATION**

The modules can be fixed on both the long and the short side of the module within the constraints shown in drawing 2, using a minimum of four clamps. The modules are built to withstand a downward force of up to 5400 Pa (550 kg/m²) or 2400 Pa (244 kg/m²) according to where they are clamped. Site-specific loads such as wind or snow which may exert forces in a different way need to be taken into consideration to ensure this limit is not exceeded for each respective mounting option.

A. FOR STANDARD MODULE WITH BACK SHEET

1. CLAMP PICTURE AS BELOW:



Figure 1 Double-side clamp



Figure 2 Single-side clamp

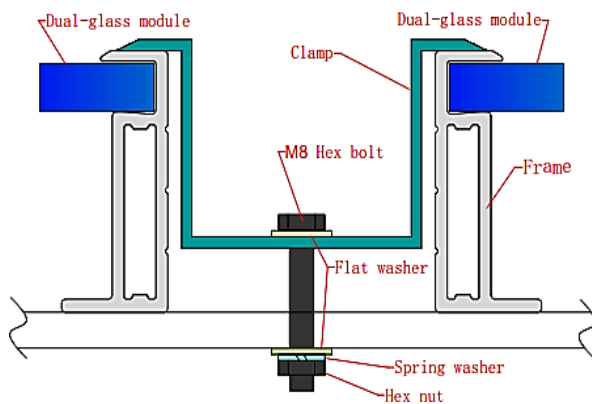

Figure 3 Double-side clamp installation

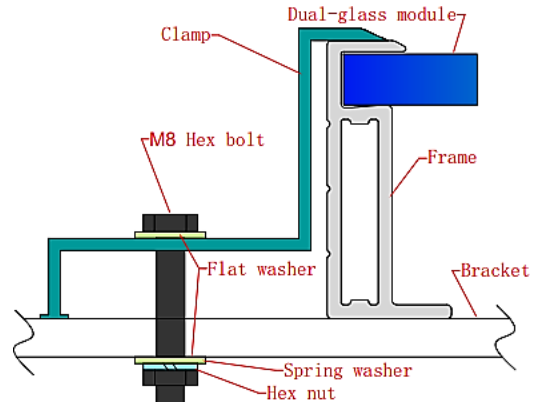
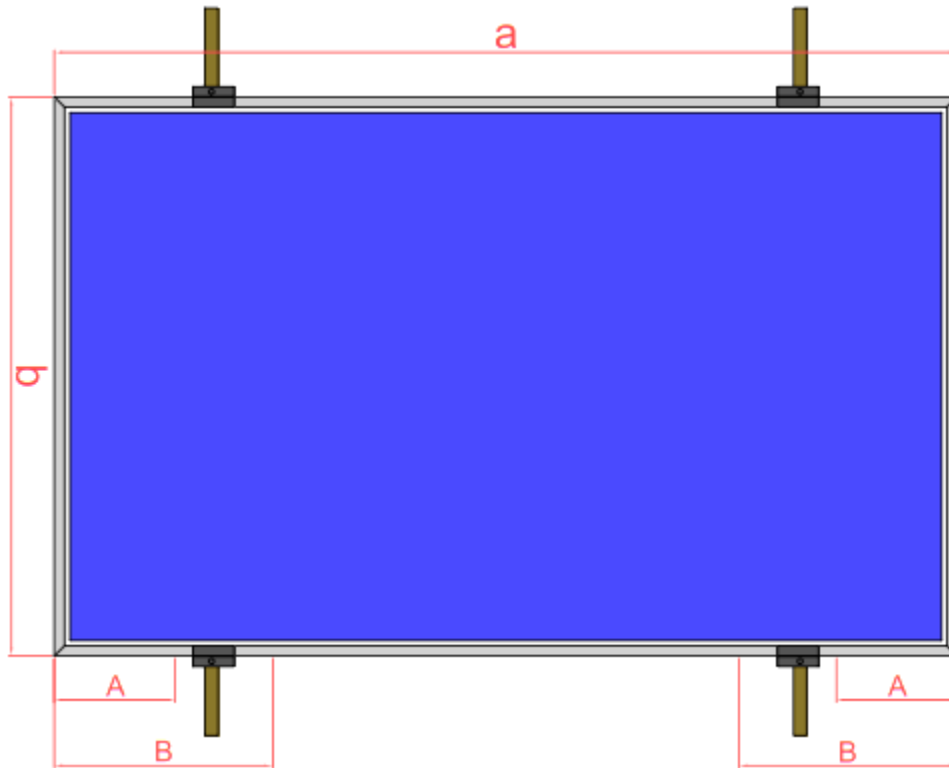

Figure 4 Single-side clamp installation

Drawing 2



Drawing 3

The selection and installation of the clamps shall obey the requirement according to table 3 (mounting area is between A and B). Otherwise the module may not satisfy the mechanical load and have the risk of broken.



Sonali Energies USA LLC.,
 111 Charlotte Place, Suite #101,
 Englewood Cliffs, NJ 07632, USA
 Tel: 201-568-1424
 salesusa@sonalisolar.com

This Installation method is applicable to the series of PV modules as listed below:

Type -1	SS-M-290W	Type -6	SS-M-430W
	SS-M-295W		SS-M-435W
	SS-M-300W		SS-M-440W
	SS-M-305W		SS-M-445W
	SS-M-310W		SS-M-450W
Type-2	SS-M-350W		SS-M-455W
	SS-M-355W		SS-M-460W
	SS-M-360W		SS-M-360W
	SS-M-365W		SS-M-365W
Type-3	SS-M-370W		SS-M-370W
	SS-M-385W	SS-M-375W	
	SS-M-390W	SS-M-380W	
	SS-M-395W	SS-M-385W	
	SS-M-400W	SS-M-390W	
	SS-M-405W	SS-M-520W	
	SS-M-410W	SS-M-525W	
	SS-M-415W	SS-M-530W	
Type-4	SS-M-420W	SS-M-535W	
	SS-M-320W	SS-M-540W	
	SS-M-325W	SS-M-545W	
	SS-M-330W	SS-M-550W	
	SS-M-335W	SS-M-475W	
	SS-M-340W	SS-M-480W	
	SS-M-345W	SS-M-485W	
Type-5	SS-M-350W	SS-M-490W	
	SS-M-415W	SS-M-495W	
	SS-M-420W	SS-M-500W	
	SS-M-425W	SS-M-505W	
	SS-M-430W	SS-M-430W	
	SS-M-435W	SS-M-435W	
	SS-M-440W	SS-M-440W	
	SS-M-445W	SS-M-445W	
SS-M-450W	SS-M-450W		
SS-M-455W	SS-M-455W		
			SS-M-460W

Table 2

Module type	a (mm)	b (mm)	Clamp length	A (mm)	B (mm)	Loads (Pa)
Type 1	1650	991	≥50 mm	180	480	3600
				0	480	1600
Type 2	1956	991	≥50 mm	280	580	1600
				0	580	1600
Type 3	2000	1002	≥50 mm	280	480	3600
				0	480	1600
Type 4	1686	1002	≥50 mm	180	580	3600
				0	580	1600
Type 5	2172	1102	≥50 mm	280	480	3600
				0	480	1600
Type 6	2094/1970/1956	1048/1002	≥50 mm	280	580	3600
				0	580	1600
Type 7	1755/1970/1956	1038/1002	≥50 mm	180	480	3600
				0	480	1600
Type 8	2279/1970/1956	1134/1002	≥50 mm	280	580	3600
				0	580	1600
Type 9	2094/1970/1956	1134/1002	≥50 mm	180	480	3600
				0	480	1600
Type 10	1712/1910/ 1970/1956	1134/1002	≥50 mm	180	480	3600
				0	480	1600

Table3



WARNING Electrical Hazard

This module produces electricity when exposed to light. Follow all applicable electrical safety precautions. **ONLY** qualified personnel can install or perform maintenance work on these modules. **BE AWARE** of dangerous high DC voltage when connecting module. **DO NOT** damage or scratch the rear surface of the module. **DO NOT** handle or install module when they are wet.



Sonali Energies USA LLC.,
111 Charlotte Place, Suite #101,
Englewood Cliffs, NJ 07632, USA
Tel: 201-568-1424
salesusa@sonalisolar.com

4. ELECTRICAL INSTALLATION

○ GENERAL INSTALLATION

- Any hardware used must be compatible with the mounting structure material to avoid galvanic corrosion
- It is not recommended to use modules with different configurations (grounding, wiring) in the same system.
- The module maximum system voltage is 1500 volts DC(For –HV module) and 1000 volts DC(For other module). For applications requiring a high operating voltage several modules can be connected in series to form a string of modules; The system voltage is then equal to the sum of the voltage of each module.
- For applications requiring high operating currents several strings of modules can be connected in parallel; the system current is then equal to the sum of the current of each string of modules.
- Our modules are supplied with connectors to be used for system electrical connections.
- The maximum number of series connected modules can calculate through this formal: $1500 / (1.25 * V_{oc})$.
- The recommended maximum parallel module configuration is 16 parallels. And the numbers of modules have something to do with system design parameters such as current or power output.
- Please refer to local regulations to determine the system wires size, type and temperature.
- To prevent the cables and the connectors from overheating, the cross section of the cables and the capacity of the connectors must be selected to suit the maximum system short circuit current (The recommended cable cross section is 4mm² for a single module and if rated current of a connector is higher than 10A). Please note that the upper limit temperature of cable is 85°C, and that of the connector is 105°C. And all the cables diameter that been used for wiring must reach at least 4 mm².
- The DC current generated by photovoltaic systems can be converted into AC and fed into a public grid. As local utilities' policies on connecting renewable energy systems to their grids

vary from region to region. A qualified system designer or integrator should always be consulted. Building permits, inspections and approvals by the local utility are generally required.

○ **GROUNDING**

- Where common grounding hardware (nuts, bolts, star washers, spilt-ring lock washers, flat washers and the like) is used to attach a listed grounding/bonding device, the attachment must be made in conformance with the grounding device manufacturer’s instructions.”
- For grounding and bonding requirements, please refer to regional and national safety and electricity standards. If grounding is required, use a recommended connector type, or an equivalent, for the grounding wire.
- If grounding is required, the grounding wire must be properly fastened to the module frame to assure adequate electrical connection.

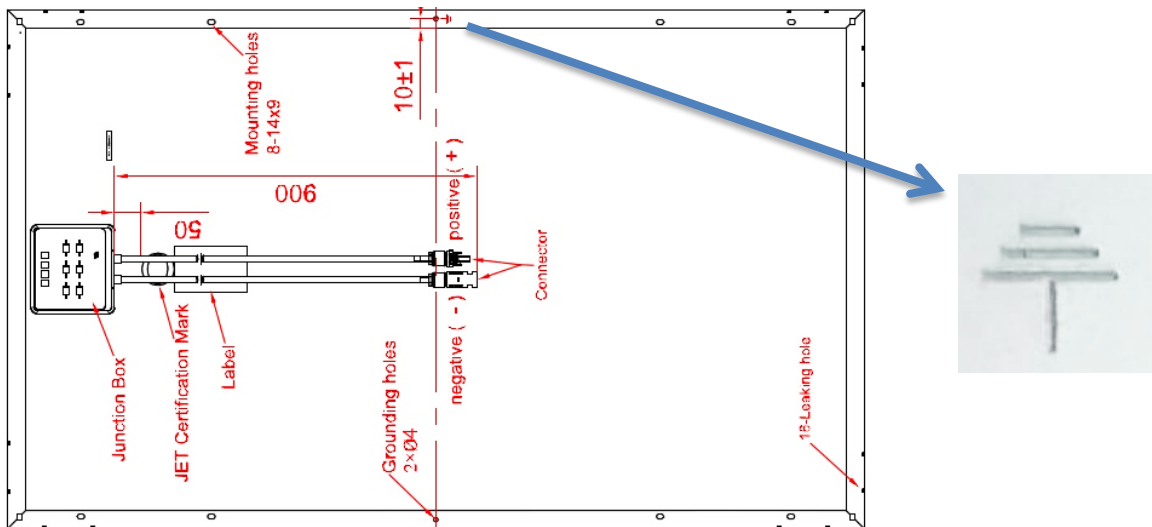

For double glass module

○ SERIES AND PARALLEL CONNECTIONS

ELECTRICAL INSTALLATION

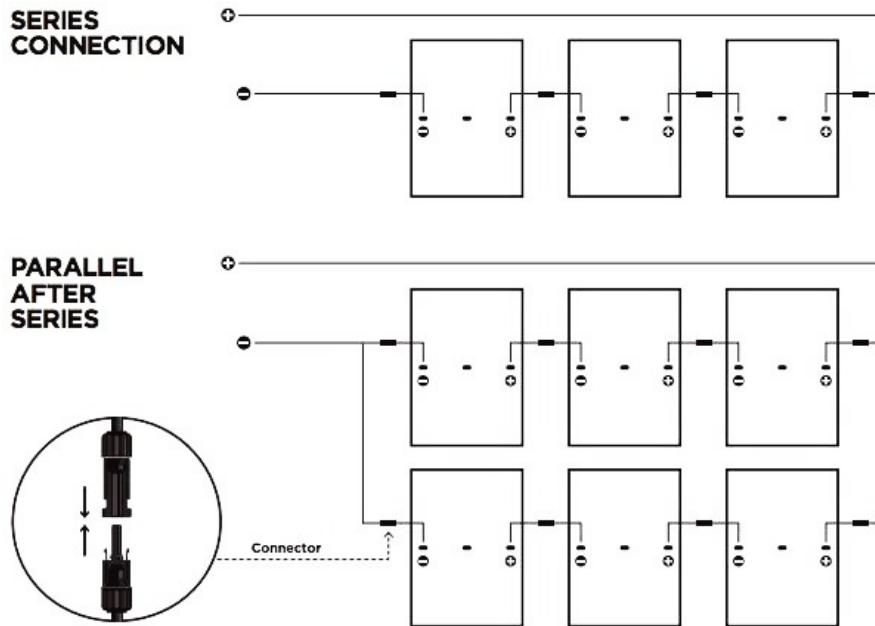

- Electrical performance parameter of module, such as nominal value of I_{sc} , V_{oc} and P_{max} has $\pm 3\%$ random error compared with value of STC. The standard testing environment of module is: Irradiance $1000/m^2$, Cell temperature $25^\circ C$, Spectrum AM 1.5.
- Normally, the current and voltage of module, will be a little higher compared with the value under STC, so when confirmed the associated parameters of solar system accessories, such as rated voltage, cable capacity, fuse capacity and module power, the corresponding short circuit current and open circuit voltage should be amplified by 1.25 times.
- The maximum number of modules per series string must be calculated according to the requirements. The value of the V_{oc} in the local expected minimum temperature cannot exceed the maximum system voltage value specified of the module (According to IEC61730 safety test, the maximum system voltage of SONALISOLARUSA Module is DC1000V) and other DC electrical components require values.

- The Voc correction factor can be calculated according to the following formula: $CVoc=1-\beta Voc \times (25-T)$, T is the minimum ambient temperature expected for the installation of the system, β (% / °C) is The temperature coefficient of the selected module Voc (according to the corresponding module data sheet).
- If the reverse current which probably exceeds the maximum fuses current of module passed through the module, the modules must be protected by an equivalent current protection device. If the number of parallel is more than or equal to 2 strings, there must be equipped an overcurrent protection device on each series of modules.
- Electrical performance parameter of module, such as nominal value of Isc, Voc and Pmas has $\pm 3\%$ random error compared with value of STC. The standard testing environment of module is: Irradiance 1000/m², Cell temperature 25°C, Spectrum AM 1.5.
- Normally, the current and voltage of module, will be a little higher compared with the value under STC, so when confirmed the associated parameters of solar system accessories, such as rated voltage, cable capacity, fuse capacity and module power, the corresponding short circuit current and open circuit voltage should be amplified by 1.25 times.
- The maximum number of modules per series string must be calculated according to the requirements. The value of the Voc in the local expected minimum temperature cannot exceed the maximum system voltage value specified of the module (According to IEC61730 safety test, the maximum system voltage of SONALISOLARUSA Module is DC1000V) and other DC electrical components require values.
- The Voc correction factor can be calculated according to the following formula: $CVoc=1-\beta Voc \times (25-T)$, T is the minimum ambient temperature expected for the installation of the system, β (% / °C) is The temperature coefficient of the selected module Voc (according to the corresponding module data sheet).
- If the reverse current which probably exceeds the maximum fuses current of module passed through the module, the modules must be protected by an equivalent current protection device. If the number of parallel is more than or equal to 2 strings, there must be equipped an overcurrent protection device on each series of modules.



Sonali Energies USA LLC.,
 111 Charlotte Place, Suite #101,
 Englewood Cliffs, NJ 07632, USA
 Tel: 201-568-1424
 salesusa@sonalisolar.com

5. MAINTENANCE

- To ensure optimum module performance, SONALISOLARUSA recommends the following maintenance measures:
- Clean the glass surface of the module when required. Always use clean water and a soft sponge or cloth for cleaning. A mild, non-abrasive cleaning agent may be used to remove stubborn dirt.
- Check the electrical, grounding and mechanical connections every six months to verify that they are clean, secure, undamaged and free of corrosion.
- If any problem arises, consult a professional for suggestions.
- Caution: observe the maintenance instructions for all components used in the system, such as support frames, charging regulators, inverters, batteries etc.

6. DIMENSION & PARAMETERS: -

Module Family A:	With Mono C-Si Cell type	
Type Name or Model No.	SS-M-xxxW	SS-M-xxxW
Maximum System Voltage (VDC)	1500	1500
Rated Maximum Power (W)	325, 330, 335, 340, 345, 350, 355, 360, 365, 370	275, 280, 285, 290, 295, 300, 305, 310
Rated Short Circuit Current (A)	9.19, 9.26, 9.36, 9.45, 9.50, 9.60, 9.69, 9.76, 9.82, 9.91	9.26, 9.35, 9.44, 9.50, 9.55, 9.64, 9.72, 9.81
Rated Open Circuit Voltage (V)	45.9, 46.1, 46.3, 46.5, 46.7, 46.9, 47.0, 47.2, 47.4, 47.6	38.8, 39.0, 39.2, 39.5, 39.7, 39.9, 40.2, 40.4
Tolerance Of Rating Pmax/Isc/Voc (%)	3/4/4	3/4/4
Over-Current Protection Rating (A)	16	16
Classification (IEC/UL 61730)	Class II	Class II
Fire Rating	Class C/Type 1	Class C/Type 1
Dimensions (LxWxH) (mm)	1956x991x40	1650x991x35
Module Area (m ²)	1.94	1.64
Min-Creepage Distance (mm)	14.75	14.75
Number Of Solar Cells	72	60
Cells per bypass diode	24	20
Serial/parallel Connection of Cells	S	S



Sonali Energies USA LLC.,
 111 Charlotte Place, Suite #101,
 Englewood Cliffs, NJ 07632, USA
 Tel: 201-568-1424
 salesusa@sonalisolar.com

Type Name or Model No.	SS-M-xxxW	SS-M-xxxW
Maximum System Voltage (VDC)	1500	1500
Rated Maximum Power (W)	385, 390, 395, 400, 405, 410, 415, 420	320, 325, 330, 335, 340, 345, 350
Rated Short Circuit Current (A)	10.21, 10.24, 10.27, 10.32, 10.35, 10.40, 10.43, 10.47	10.20, 10.27, 10.33, 10.39, 10.46, 10.53, 10.59
Rated Open Circuit Voltage (V)	48.4, 48.6, 48.8, 49.0, 49.2, 49.4, 49.6, 49.8	40.2, 40.4, 40.6, 40.8, 41.0, 41.5, 41.4
Tolerance Of Rating Pmax/Isc/Voc (%)	3/3/3	3/3/3
Over-Current Protection Rating (A)	25	25
Classification (IEC/UL 61730)	Class II	Class II
Fire Rating	Class C/Type 1	Class C/Type 1
Dimensions (LxWxH) (mm)	2000x1002x40	1686x1002x35
Module Area (m ²)	2.0	1.69
Min-Creepage Distance (mm)	14.88	14.88
Number Of Solar Cells	144	120
Cells per bypass diode	48	40
Serial/parallel Connection of Cells	SP	SP

Type Name or Model No.	SS-M-xxxW
Maximum System Voltage (VDC)	1500
Rated Maximum Power (W)	415, 420, 425, 430, 435, 440, 445, 450, 455
Rated Short Circuit Current (A)	10.06, 10.12, 10.18, 10.24, 10.30, 10.37, 10.42, 10.47, 10.54
Rated Open Circuit Voltage (V)	52.1, 52.3, 52.5, 52.7, 52.9, 53.1, 53.3, 53.5, 53.7
Tolerance Of Rating Pmax/Isc/Voc (%)	3/3/3
Over-Current Protection Rating (A)	25
Classification (IEC/UL 61730)	Class II
Fire Rating	Class C/Type 1
Dimensions (LxWxH) (mm)	2172x1002x40
Module Area (m ²)	2.18
Min-Creepage Distance (mm)	14.88
Number Of Solar Cells	156
Cells per bypass diode	52
Serial/parallel Connection of Cells	SP



Sonali Energies USA LLC.,
 111 Charlotte Place, Suite #101,
 Englewood Cliffs, NJ 07632, USA
 Tel: 201-568-1424
 salesusa@sonalisolar.com

Type Name or Model No.	SS-M-xxxW	SS-M-xxxW
Maximum System Voltage (VDC)	1500	1500
Rated Maximum Power (W)	430, 435, 440, 445, 450, 455, 460, 465	360, 365, 370, 375, 380, 385
Rated Short Circuit Current (A)	11.23, 11.26, 11.29, 11.32, 11.35, 11.38, 11.41, 11.44	11.24, 11.30, 11.36, 11.42, 11.48, 11.54
Rated Open Circuit Voltage (V)	48.70, 48.85, 49.00, 49.15, 49.30, 49.45, 49.60, 49.75	40.6, 40.8, 41.0, 41.2, 41.4, 41.6
Tolerance Of Rating Pmax/Isc/Voc (%)	3/3/3	3/3/3
Over-Current Protection Rating (A)	25	25
Classification (IEC/UL 61730)	Class II	Class II
Fire Rating	Class C/Type 1	Class C/Type 1
Dimensions (LxWxH) (mm)	2108x1048x35/40 2094x1038x35/40	1765x1048x35 1755x1038x35
Module Area (m ²)	2.21 / 2.17	1.85 / 1.82
Min-Creepage Distance (mm)	13.75	13.8
Number Of Solar Cells	144	120
Cells per bypass diode	48	40
Serial/parallel Connection of Cells	SP	SP
Design Load Down/Up (Pa)	3600/1600	3600/1600
Safety Factor	1.5	1.5

Type Name or Model No.	SS-M-xxxW	SS-M-xxxW
Maximum System Voltage (VDC)	1500	1500
Rated Maximum Power (W)	525, 530, 535, 540, 545, 550,555	485, 490, 495, 500, 505
Rated Short Circuit Current (A)	13.48, 13.54, 13.60, 13.66, 13.72, 13.78, 13.84	13.60, 13.66, 13.72, 13.78, 13.84
Rated Open Circuit Voltage (V)	49.2, 49.4, 49.6, 49.8, 50.0, 50.2, 50.4	45.2, 45.4, 45.6, 45.8, 46.0
Tolerance Of Rating Pmax/Isc/Voc (%)	3/3/3	3/3/3
Over-Current Protection Rating (A)	25	25
Classification (IEC/UL 61730)	Class II	Class II
Fire Rating	Class C/Type 1	Class C/Type 1
Dimensions (LxWxH) (mm)	2279x1134x35/40 2256x1134x35/40	2094x1134x35/40 2074x1134x35/40
Module Area (m ²)	2.58 / 2.56	2.37 / 2.35
Min-Creepage Distance (mm)	13.75	13.75
Number Of Solar Cells	144	132
Cells per bypass diode	48	44
Serial/parallel Connection of Cells	SP	SP
Design Load Down/Up (Pa)	3600/1600	3600/1600
Safety Factor	1.5	1.5



Sonali Energies USA LLC.,
 111 Charlotte Place, Suite #101,
 Englewood Cliffs, NJ 07632, USA
 Tel: 201-568-1424
 salesusa@sonalisolar.com

Type Name or Model No.	SS-M-xxxW	SS-M-xxxW
Maximum System Voltage (VDC)	1500	1500
Rated Maximum Power (W)	440, 445, 450, 455, 460	390,395,400
Rated Short Circuit Current (A)	13.54, 13.60, 13.66, 13.72, 13.78	13.62,13.71,13.73
Rated Open Circuit Voltage (V)	41.2, 41.4, 41.6, 41.8, 42.0	36.81,36.9,37.1
Tolerance Of Rating Pmax/Isc/Voc (%)	3/3/3	3/3/3
Over-Current Protection Rating (A)	25	25
Classification (IEC/UL 61730)	Class II	Class II
Fire Rating	Class C/Type 1	Class C/Type 1
Dimensions (LxWxH) (mm)	1910x1134x35/40 1891x1134x35/40	1712x1134x35/40
Module Area (m ²)	2.17 / 2.14	1.94
Min-Creepage Distance (mm)	14.88	14.88
Number Of Solar Cells	120	108
Cells per bypass diode	40	40
Serial/parallel Connection of Cells	SP	SP
Design Load Down/Up (Pa)	3600/1600	3600/1600
Safety Factor	1.5	1.5