

IQ8MC, IQ8AC, IQ8HC, and IQ8X Microinverters

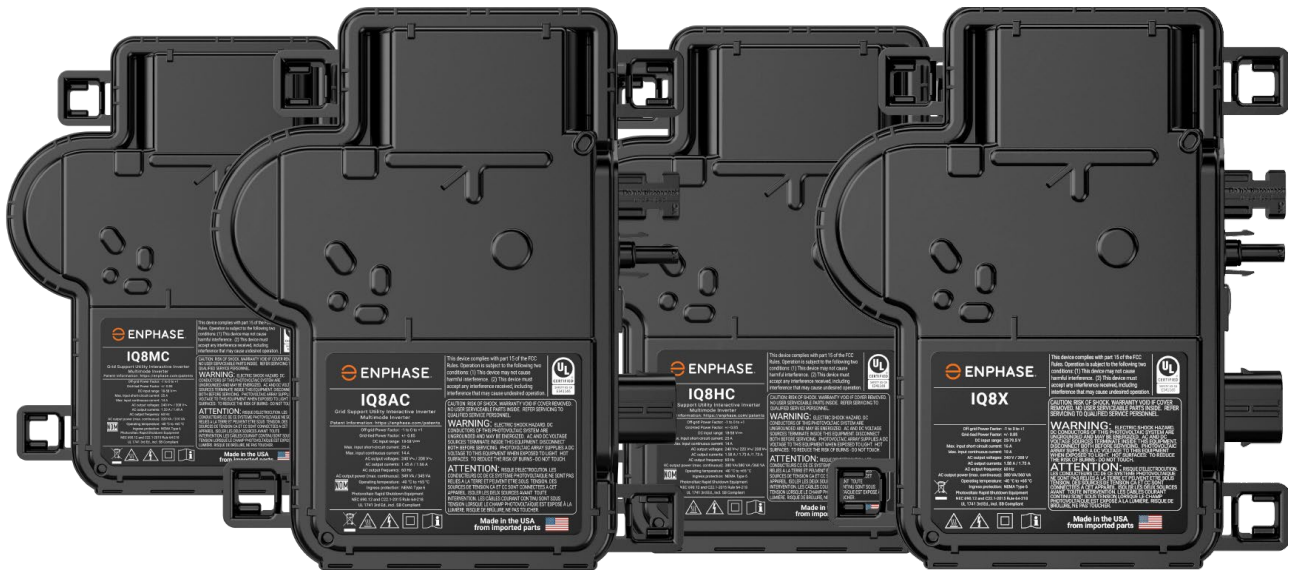

Corporate Headquarters Contact Information

Enphase Energy Inc.
1420 N. McDowell Blvd. Petaluma, CA 94954
USA
enphase.com/en-us/contact/support

FCC Compliance

This equipment has been tested and found to comply with the limits for a Class B digital device, pursuant to part 15 of the FCC rules. These limits are designed to provide reasonable protection against harmful interference in a residential installation. This equipment generates, uses, and can radiate radio frequency energy and, if not installed and used in accordance with the instructions, may cause harmful interference to radio communications. However, there is no guarantee that interference will not occur in a particular installation. If this equipment does cause harmful interference to radio or television reception, which can be determined by turning the equipment off and on, you are encouraged to try to correct the interference by one or more of the following measures:

- Reorient or relocate the receiving antenna.
- Increase the separation between the equipment and the receiver.
- Connect the equipment to an outlet on a circuit different from that to which the receiver is connected.
- Consult the dealer or an experienced radio/TV technician for help.

Changes or modifications not expressly approved by the party responsible for compliance may void the user's authority to operate the equipment.

Other Information

Product information is subject to change without notice. All trademarks are recognized as the property of their respective owners.

User documentation is updated frequently; check the Enphase website (<https://enphase.com/installers/resources/documentation>) for the latest information.

To ensure optimal reliability and to meet warranty requirements, the Enphase microinverter must be installed according to the instructions in this manual. For warranty text refer to enphase.com/warranty.

For Enphase patent information refer to enphase.com/company/patents.

© 2023 Enphase Energy. All rights reserved. Enphase, the e and CC logos, IQ, and certain other marks listed at <https://enphase.com/trademark-usage-guidelines> are trademarks of Enphase Energy, Inc. in the US and other countries. Data subject to change.

Audience

This manual is intended for use by professional installation and maintenance personnel.

Contents

- Important safety information5**
 - Read this first5
 - Product labels.....5
 - Safety and advisory symbols5
 - IQ8 Series Microinverters safety instruction5
 - PV rapid shutdown equipment (PVRSE).....8
 - Anti-islanding methodology8
- Enphase System9**
 - How the Enphase IQ8 Series Microinverters work.....10
 - System monitoring10
 - Optimal reliability.....10
 - Ease of design.....10
- Planning for microinverter installation..... 11**
 - Compatibility11
 - Grounding considerations.....11
 - Branch circuit capacity.....12
 - Utility service requirements12
 - Wire lengths and voltage rise.....12
 - Lightning and surge suppression13
- Parts and tools required 14**
 - Enphase equipment.....14
 - Other items14
- Enphase microinverters installation 15**
 - Step 1: Position the IQ Cable16
 - Step 2: Position the junction box16
 - Step 3: Mount the microinverters.....16
 - Step 4: Create an installation map.....17
 - Step 5: Manage the cabling18
 - Step 6: Connect the microinverters.....18
 - Step 7: Terminate the unused end of the cable19
 - Step 8: Complete the installation of the junction box20
 - Step 9: Connect the PV modules.....20
 - Step 10: Enphase Energy System configurations.....20
- Troubleshooting 25**
 - Status LED indications and error reporting25
 - LED operation25
 - DC Resistance Low – Power Off condition.....25

Other faults	26
Troubleshoot an inoperable microinverter	26
Disconnect a microinverter	27
Install a replacement microinverter	27
Enphase IQ Cable planning and ordering	28
Connector spacing options.....	28
IQ Cable options	28
Enphase IQ Cable accessories.....	29
Technical considerations	29
Bifacial modules	29
Specifications.....	30
IQ8MC-72-M-US Microinverter specifications	30
IQ8AC-72-M-US Microinverter specifications	32
IQ8HC-72-M-US Microinverter specifications	34
IQ8X-80-M-US Microinverter specifications.....	36
IQ Cable specifications	38
Enphase connector ratings	38
Enphase installation map	39
Sample Wiring Diagram (grid-tied system).....	40
Revision history	41

Important safety information





Read this first

This manual contains important instructions for use during the installation and maintenance of the IQ8 Series Microinverters.

IMPORTANT: IQ8 Series Microinverters require the IQ Cable. An IQ Gateway is required to monitor the performance of the IQ Microinverters. The IQ accessories work only with IQ8 Series Microinverters.





Product labels

The following symbols appear on the **product label** and are described here:

-  **WARNING:** Hot surface
-  **DANGER:** Refer to safety instructions
-  **DANGER:** Risk of electric shock
-  **Refer to manual**
-  **Double-insulated**



Safety and advisory symbols



To reduce the risk of electric shock and to ensure the safe installation and operation of the IQ8 Series Microinverters System, the following safety symbols appear throughout this document to indicate dangerous conditions and important safety instructions.

	DANGER:	This indicates a hazardous situation, which, if not avoided, will result in death or serious injury.
	WARNING	This indicates a situation where failure to follow instructions may be a safety hazard or cause equipment malfunction. Use extreme caution and follow instructions carefully.
	WARNING:	This indicates a situation where failure to follow instructions may result in burn injury.
	NOTE:	This indicates information that is very important for optimal system operation. Follow instructions closely.





IQ8 Series Microinverters safety instruction



General safety

	DANGER: Risk of electric shock. Risk of fire.	Only use electrical system components approved for wet locations.
		Only qualified personnel should install, troubleshoot, or replace Enphase microinverters or IQ Cable and accessories.
		Ensure that all AC and DC wiring is correct and that none of the AC or DC cables are pinched, shorted, or damaged. Ensure that all AC junction boxes are properly closed.
	DANGER: Risk of electric shock.	Do not exceed the maximum number of microinverters in an AC branch circuit as listed in the manual. You must protect each microinverter AC branch circuit with a 20 A maximum breaker or fuse as appropriate.
		Do not use Enphase equipment in a manner not specified by the manufacturer. Doing so may cause death or injury to persons or damage to equipment.
		Be aware that installation of this equipment includes the risk of electric shock.
		The DC conductors of this photovoltaic system are ungrounded and may be energized.





	WARNINGS:	Always de-energize the AC branch circuit before servicing. Never disconnect the DC or AC connectors under load.
		Before installing or using the Enphase microinverter, read all instructions and cautionary markings in the technical description of the Enphase equipment and the photovoltaic (PV) equipment.
		Do not connect Enphase microinverters to the grid or energize the AC circuit(s) until you have completed all of the installation procedures and have received approval from the electrical utility.
		When the PV array is exposed to light, DC voltage is supplied to the power conversion equipment (PCE).
		Risk of equipment damage. Enphase male and female connectors must only be mated with the identical type and brand of male/female connector.
	NOTES:	To ensure optimal reliability and to meet warranty requirements, install the Enphase equipment according to the instructions in this manual.
		DANGER: Risk of electric shock. Always de-energize the AC branch circuit before servicing. Never disconnect the DC or AC connectors under load. When the system has an IQ System Controller, then the RSD must be switched to the off/open position to de-energize the AC PV circuit.
		Protection against lightning and resulting voltage surges must be in accordance with local standards.
		Perform all electrical installations in accordance with all applicable local electrical codes, such as the Canadian Electrical Code, Part 1; ANSI requirements; and NPFA 70 (NEC).

Microinverter safety

	WARNING: Risk of skin burn.	The chassis of the Enphase microinverter is the heat sink. Under normal operating conditions, the temperature could be 20°C above ambient temperature, but under extreme conditions, the microinverter can reach a temperature of 90°C. To reduce the risk of burns, use caution when working with microinverters.
	DANGER: Risk of fire.	The DC conductors of the PV module must be labeled "PV Wire" or "PV Cable" when paired with the Enphase microinverter.
	DANGER: Risk of electric shock. Risk of fire.	Only qualified personnel may connect the Enphase microinverter to the utility grid. Do not attempt to repair the Enphase microinverter; it contains no user-serviceable parts. If it fails, contact Enphase Support to obtain a return merchandise authorization (RMA) number and start the replacement process. Tampering with or opening the Enphase microinverter will void the warranty.
	WARNING: Risk of equipment damage.	Install the microinverter under the PV module to avoid direct exposure to rain, UV, and other harmful weather events. Always install the microinverter bracket side up. Do not mount the microinverter upside down. Do not expose the AC or DC connectors (on the IQ Cable, PV module, or microinverter) to rain or condensation before the connectors are mated. The maximum open circuit voltage of the PV module must not exceed the specified maximum input DC voltage of the Enphase microinverter. Refer to the Enphase compatibility calculator to verify PV module electrical compatibility with the microinverter. Use IQ8 Series Microinverters only with compatible PV modules per the Enphase compatibility calculator. Using an electrically incompatible PV module voids Enphase warranty.
	WARNING: Risk of equipment damage.	You must match the DC operating voltage range of the PV module with the allowable input voltage range of the Enphase microinverter. The Enphase microinverter is not protected from damage due to moisture trapped in cabling systems. Never mate microinverters to cables left disconnected and exposed to wet conditions. This voids the Enphase warranty.

	WARNING: Risk of equipment damage.	The Enphase microinverter functions only with a standard, compatible PV module with appropriate fill factor, voltage, and current ratings. Unsupported devices include smart PV modules, fuel cells, wind or water turbines, DC generators, non-Enphase batteries, etc. These devices do not behave like standard PV modules, so operation and compliance are not guaranteed. These devices may also damage the Enphase microinverter by exceeding its electrical rating, making the system unsafe.
	NOTES:	The Enphase microinverter has field-adjustable voltage and frequency trip points that may need to be set, depending upon local requirements. Contact Enphase Support for required modifications as per local requirements.
	NOTES:	Installers must check the manufacturing date of the products to ensure that the installation date is within one year of the manufactured date of the products. Contact your local distributor to validate the date code.

Enphase IQ Cable safety

	DANGER: Risk of electric shock.	Do not install the IQ Terminator while the power is connected.
	WARNING: Risk of electric shock. Risk of fire.	When stripping the sheath from the IQ Cable, make sure the conductors are not damaged. If the exposed wires are damaged, the system may not function properly. Do not leave AC connectors on the IQ Cable uncovered for an extended period. You must cover any unused connector with an IQ Sealing Cap. Make sure a protective IQ Sealing Cap has been installed on all unused AC connectors. Unused AC connectors are live when the system is energized.
	WARNING:	Use the IQ Terminator only once. If you open the IQ Terminator following installation, the latching mechanism is destroyed. If the latching mechanism is defective, do not use the IQ Terminator. Do not circumvent or manipulate the latching mechanism. When installing the IQ Cable, secure any loose cable to minimize tripping hazards.
	NOTES:	When looping the IQ Cable, do not form loops smaller than 4.75" (12 cm) in diameter. Provide support for the IQ Cable every 1.8 m (6 ft). If you need to remove IQ Sealing Cap, use IQ Disconnect Tool. When installing the IQ Cable and accessories, adhere to the following: <ul style="list-style-type: none"> • Do not expose the IQ Terminator cap or cable connections to directed, pressurized liquid (water jets, etc.). • Do not expose the IQ Terminator or IQ Cable to continuous immersion. • Do not expose the IQ Terminator cap or IQ Cable connections to continuous tension (e.g., tension due to pulling or bending the cable near the connection). • Use only the connectors provided. • Do not allow contamination or debris in the connectors. • Use the IQ Terminator cap and cable connections only when all parts are present and intact. • Do not install or use in potentially explosive environments. • Do not allow the IQ Terminator to come into contact with open flame. • Fit the IQ Terminator cap using only the prescribed tools and in the prescribed manner. • Use only the IQ Terminator to seal the conductor end of the IQ Cable; no other method is allowed.

DC cable safety

	NOTES:	<ul style="list-style-type: none"> • Ensure proper routing of PV Module DC cable using the clips to prevent the leads from resting on the roof. Do not wrap excess DC cable around the microinverter. • Avoid direct exposure to sunlight. • Avoid sharp edges on racking. • Avoid cable contacting rough surfaces or moving parts within the racking system. • Avoid overly tight bending radii. The minimum bend radii for the DC cable is 8 X cable outer diameter. • Avoid overly tight cable clips for routing.
---	---------------	--

PV rapid shutdown equipment (PVRSE)

This product is UL Listed as PV rapid shutdown equipment and conforms with NEC-2014, NEC-2017, NEC-2020, and NEC-2023 section 690.12, and C22.1-2018 Rule 64-218 Rapid Shutdown of PV Systems for AC and DC conductors, when installed according to the following requirements:

- Microinverters and all DC connections must be installed inside the array boundary. Enphase further requires installing microinverters and DC connections under the PV module to avoid direct exposure to rain, UV, and other harmful weather events.
- The array boundary is defined as 305 mm (1 ft.) from the array in all directions or 1 m (3 ft.) from the point of entry inside a building.

This Rapid Shutdown system must have an initiating device or status indicator installed in a location accessible to first responders. Alternately, it must be connected to an automatic system that initiates Rapid Shutdown in the event a system disconnects or another emergency system is activated.

The initiator shall be listed and identified as a disconnecting means that plainly indicates whether it is in the "off" or "on" position. Examples are the following:

When installed with IQ System Controller

- PV system disconnecting means RSD - The Enphase System Shutdown switch provides the functionality of rapid shutdown as mandated by NEC when it is used with IQ System Controller 2, which has an IQ8 Series Microinverters connected to it. For more information on rapid shutdown, refer to the [rapid shutdown FAQ](#).

In a grid-tied PV-only system:

- Service disconnecting means
- Readily accessible switch or circuit breaker

The handle position of a switch or circuit breaker is suitable for use as an indicator. Refer to NEC or CSA C22.1-2018 for more information.

Additionally, in a prominent location near the initiator device, a placard or label must be provided with a permanent marking including the following wording:

'PHOTOVOLTAIC SYSTEM EQUIPPED WITH RAPID SHUTDOWN' The term 'PHOTOVOLTAIC' may be replaced with 'PV.' The placard, label, or directory shall be reflective, with all letters capitalized and having a minimum height of 9.5 mm (3/8 in) in white on a red background.

Anti-islanding methodology

The anti-islanding methodology used by Enphase IQ8 Series Microinverters is listed by UL and tested in accordance with IEEE1547-2018 and UL1741-SB.

IQ8 Series Microinverter uses the Group 1 method of anti-islanding based on the definitions provided in the list below as defined in [Sand2018-8431, July 2018](#):

Group 1: Frequency Shift with continuous positive frequency feedback

Group 2A: Frequency Shift with discontinuous or stepped positive frequency feedback

Group 2B: Frequency Shift similar to Group 2A except with a dead zone around 60 Hz

Group 2C: Frequency shift with unidirectional frequency feedback

Group 3: Monitors change of impedance

Group 4: Monitors shift at a harmonic frequency (multiple of the fundamental)

Group 5: Passive methods like rate of change of frequency, vector shift

Group 6: Produces negative sequence current and monitors the voltage

For any questions, please contact [Enphase Support](#)

Enphase system

The Enphase system includes:

- **IQ8MC, IQ8AC, IQ8HC, and IQ8X Microinverters:** The smart, grid-ready IQ8 Series Microinverters that convert the DC output of the PV module into grid-compliant AC power.
- **IQ Gateway (ENV-IQ-AM1-240, ENV2-IQ-AM1-240):** Is required to monitor solar production, propagate a grid profile to the microinverters, and provide microinverter control at sites where power export limitation (PEL), and/or phase imbalance management (PIM) is required through advanced grid functionalities. The IQ Gateway is a communication device that provides network access to the PV array. The IQ Gateway collects production and performance data from the Enphase IQ Microinverters over on-site AC power lines and transmits the data to Enphase App through a broadband or cellular connection. The IQ Gateway can monitor up to 600 Enphase IQ Microinverters and up to 39 IQ Batteries.



NOTE: All installations require that you use the IQ Gateway to commission the Microinverters to propagate correct grid profile settings. This will also ensure that the microinverter's firmware is upgraded whenever a newer version is available.

- **Enphase Installer Platform:** A web-based monitoring and management software. Installers can use Enphase Installer Platform to view detailed performance data, manage multiple PV systems, and remotely resolve issues that might impact system performance. Find out more at enphase.com/enlighten.
- **Enphase Installer App:** A mobile app for iOS and Android devices. It allows installers to configure the system on-site, eliminating the need for a laptop and improving installation efficiency. You can use the app to:
 - Connect to the IQ Gateway over a wireless network for faster system setup and verification.
 - View and email a summary report that confirms a successful installation.
 - Scan device serial numbers and sync system information with the Enphase Installer Platform.
- **IQ Battery:** Offers energy storage solutions.
- **IQ Field Wireable Connectors (Q-CONN-10F and Q-CONN-10M):** Make connections from any IQ Cable or open IQ Field Wireable Connector.

This manual describes the safe installation and operation of the IQ8 Series Microinverters.



NOTE: To ensure optimal reliability and to meet warranty requirements, Enphase microinverters must be installed according to the instructions in this manual.

How the Enphase IQ8 Series Microinverters work

The Enphase microinverter maximizes energy production using a sophisticated maximum power point tracking (MPPT) algorithm. Each Enphase microinverter individually connects to one PV module in your array. This configuration enables an individual MPPT to control each PV module, ensuring that the maximum power available from each PV module is produced regardless of the performance of the other PV modules in the array. While an individual PV module in the array may be affected by shading, soiling, orientation, or mismatch, each Enphase microinverter ensures top performance for its associated PV module.

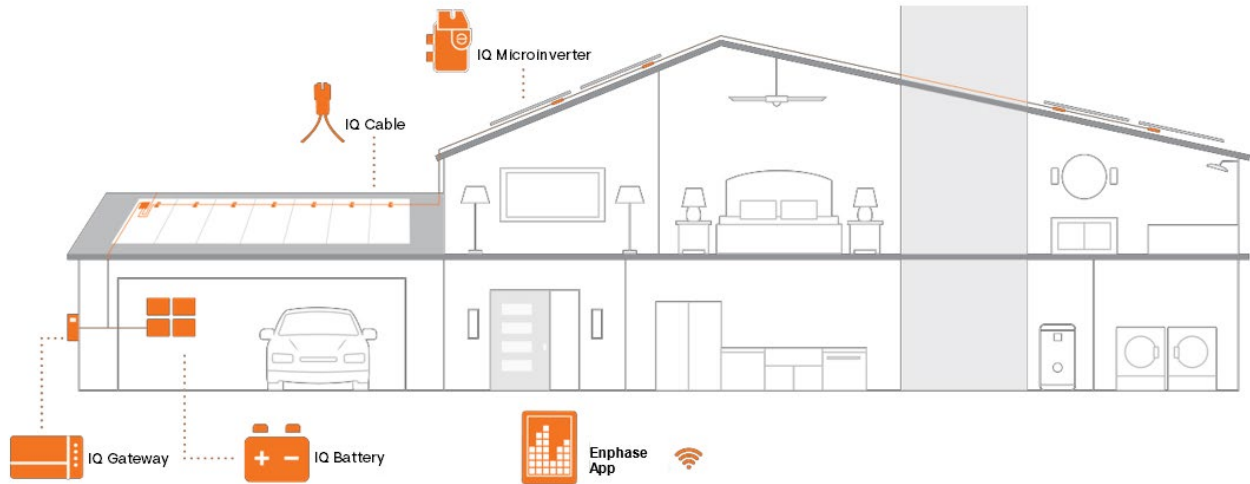

System monitoring

Once you install the IQ Gateway and provide an internet connection through a broadband router or modem, the IQ8 Series Microinverters automatically begin reporting to the Enphase Installer Platform. Enphase Installer Platform presents current and historical system performance trends and informs you of PV system status.

Optimal reliability

Microinverter systems are inherently more reliable than conventional string inverters. The distributed nature of a microinverter system ensures no single point of system failure in the PV system. Enphase microinverters are designed to operate at full power at ambient temperatures as high as 65°C (149°F).

Ease of design

PV systems using Enphase microinverters are very simple to design and install. Unlike conventional string inverters, you will not need to perform cumbersome string sizing calculations. You can install individual PV modules in any combination of PV module quantity, type, age, and orientation. Each microinverter quickly mounts on the PV racking, directly beneath each PV module. Low-voltage DC wires connect from the PV module directly to the co-located microinverter, eliminating the risk of personnel exposure to dangerously high DC voltage.

Planning for microinverter installation

All of them install quickly and easily. The microinverter housing is designed for outdoor installation and complies with the NEMA 250, type 6 environmental enclosure rating standard.



NEMA 6 rating definition: Indoor or outdoor use primarily to provide protection against hose-directed water, the entry of water during occasional temporary submersion at a limited depth, and damage from external ice formation.

The IQ Cable is available with connector spacing options to accommodate the installation of PV modules in portrait or landscape orientation. For IQ Cable ordering information, see [Enphase IQ Cable planning and ordering](#).

Compatibility

The IQ8 Series Microinverters are **electrically compatible** with PV modules, as listed in the following table. There is no enforced DC/AC ratio and maximum DC input power limit. Modules can be paired if the "Open Circuit Voltage (V_{OC})" and "Short Circuit Current (I_{SC})" of the PV module at the extreme temperatures (lowest temperature for voltage and highest temperature for current) do not exceed the microinverter's "Max. Input DC voltage" and "Max Module I_{SC} " specifications respectively. For specifications, see [Specifications](#). You can refer to the [Enphase compatibility calculator](#) to verify PV module electrical compatibility. To ensure **mechanical compatibility**, the microinverter's male and female connectors must only be mated with the identical type and brand of the male and female connectors.



WARNING: Risk of fire. The DC conductors of the PV module must be labeled "PV Wire" or "PV Cable" to comply with NEC for Ungrounded PV Power Systems.

Microinverter model	Connector type	Module compatibility
IQ8MC-72-M-US	Stäubli MC4	To meet compatibility, PV modules must be within the following maximum input DC voltage and maximum module I_{SC} . Module compatibility can be checked at https://enphase.com/installers/microinverters/calculator .
IQ8AC-72-M-US		
IQ8HC-72-M-US		
IQ8X-80-M-US		



NOTE: Some Enphase microinverters will not export power until the IQ Gateway is installed and all the microinverters are detected at the site. Additionally, the grid profile must be configured, and the IQ Gateway must have propagated these settings to the microinverters. For instructions on this procedure, refer to [IQ Gateway Installation and Operation Manual](#).

Grounding considerations

The Enphase microinverter models listed in this guide do not require grounding electrode conductors (GEC), equipment grounding conductors (EGC), or grounded conductor (neutral). Your authority having jurisdiction (AHJ) may require you to bond the mounting bracket to the racking. If so, use UL2703 hardware or star washers. The microinverter has a Class II double-insulated rating, including ground fault protection (GFP). To support GFP, use only PV modules equipped with DC cables labeled "PV Wire" or "PV Cable."

Branch circuit capacity

Plan your AC branch circuits to meet the following limits for the maximum number of microinverters per branch when protected with a 20 A (maximum) over current protection device (OCPD).

Maximum* IQ8MC Microinverters per AC branch circuit (240 VAC)	Maximum* IQ8AC Microinverters per AC branch circuit (240 VAC)	Maximum* IQ8HC Microinverters per AC branch circuit (240 VAC)	Maximum* IQ8X Microinverters per AC branch circuit (240 VAC)
12	11	10	10
Maximum* IQ8MC Microinverters per AC branch circuit (208 VAC)	Maximum* IQ8AC Microinverters per AC branch circuit (208 VAC)	Maximum* IQ8HC Microinverters per AC branch circuit (208 VAC)	Maximum* IQ8X Microinverters per AC branch circuit (208 VAC)
10	9	9	9
Maximum* IQ8MC Microinverters per AC branch circuit (220 VAC)**	Maximum* IQ8AC Microinverters per AC branch circuit (220 VAC)**	Maximum* IQ8HC Microinverters per AC branch circuit (220 VAC)**	Maximum* IQ8X Microinverters per AC branch circuit (220 VAC)
NA	NA	9	NA



NOTE: *Limits may vary. Refer to local requirements to define the number of microinverters per branch in your area.

** Only IQ8HC supports 220 V Grid in Mexico.

Utility service requirements

The IQ8 Series Microinverters work with single-phase service. Measure AC line voltages at the electrical utility connection to confirm that it is within the ranges in the following table:

240 VAC, single-phase	
L1 to L2	211 to 264 VAC
L1, L2 to ground	106 to 132 VAC
208 VAC, single-phase	
L1 to L2	183 to 229 VAC
L1, L2 to ground	106 to 132 VAC
220 VAC, single-phase**	
L1 to L2	198 to 264 VAC
L1, L2 to ground	106 to 132 VAC



NOTE: All installations require that you use the IQ Gateway to commission the microinverters to propagate correct grid profile settings. This will also ensure that the microinverter's firmware is upgraded whenever a newer version is available.

** Only IQ8HC supports 220 V Grid in Mexico.

Wire lengths and voltage rise

When planning the system, select the appropriate AC conductor size to minimize voltage rise. Select the correct wire size based on the distance from the microinverter AC branch circuit's beginning to the load center breaker. Enphase recommends a voltage rise of less than 2% for the sections from the microinverter AC branch circuit to the breaker in the load center.

Enphase guides choosing wire size and maximum conductor lengths in the Voltage Rise Technical Brief at [Enphase Support](#). Refer to this brief for voltage rise values in IQ Cables and how to calculate voltage rise in other wire sections of the system.

Standard guidelines for voltage rise on feeder and AC branch circuit conductors might not be sufficient for microinverter AC branch circuits that contain the maximum allowable microinverters. This is due to the high inherent voltage rise on the AC branch circuit.



Best practice: Center-feed the branch circuit to minimize voltage rise in a fully populated branch. This practice greatly reduces the voltage rise as compared with an end-fed branch. To center-feed a branch, divide the circuit into two sub-branch circuits protected by a single OCPD.

Lightning and surge suppression

Enphase microinverters have integral surge protection, greater than most traditional inverters. However, if the surge has sufficient energy, the protection built into the microinverter can be exceeded, and the equipment can be damaged. For this reason, Enphase recommends that you protect your system with a lightning and/or surge suppression device. In addition to having some level of surge suppression, it is also important to have insurance that protects against lightning and electrical surges. Enphase has tested the following devices:

- [Leviton 51110-SRG](#)
- [Schneider SquareD HEPD50](#)



NOTE: Protection against lightning and resulting voltage surges must be per local standards.

Parts and tools required

In addition to the microinverters, PV modules, and racking, you will need the following:

Enphase equipment

- **IQ Gateway:** Required to monitor production. IQ Gateway (model ENV-IQ-AM1-240, ENV2-IQ-AM1-240) communications gateway or IQ Combiner (model X-IQ-AM1-240-B, X-IQ-AM1-240-2, X2-IQ-AM1-240-4C, X2-IQ-AM1-240-4, X-IQ-AM1-240-4C, X-IQ-AM1-240-4).
- **Enphase Installer App:** Download the Enphase Installer App, open it, and log in to your Enphase Installer Platform account. Use it later to scan microinverter serial numbers and connect to the IQ Gateway to track system installation progress. To download, go to enphase.com/toolkit or scan the QR code at right.
- **Tie wraps or IQ Cable Clips** (Q-CLIP-100)
- **IQ Sealing Cap** (Q-SEAL-10) for any unused drops on the IQ Cable.
- **IQ Terminator** (Q-TERM-10) typically two needed per branch circuit.
- **IQ Disconnect Tool** (Q-DISC-10)
- **IQ Field Wireable Connectors** (male and female: Q-CONN-10M and Q-CONN-10F)
- **IQ Cable:**



Cable model	Connector spacing	PV module orientation	Connector count per box
Q-12-10-240	1.3 m	Portrait	240
Q-12-17-240	2.0 m	Landscape (60-cell)	240
Q-12-20-200	2.3 m	Landscape (72-cell)	200

Other items

- AC junction box
- Number 2 and 3 screwdrivers
- Wire cutters, voltmeter
- Torque wrench, sockets, and wrenches for mounting hardware
- Power drill or impact driver

Enphase microinverters installation

Installing the IQ8 Series Microinverters involves several key steps. Each step listed here is detailed in the following pages.

- Step 1:** Position the IQ Cable
- Step 2:** Position the junction box
- Step 3:** Mount the microinverters
- Step 4:** Create an installation map
- Step 5:** Manage the cabling
- Step 6:** Connect the microinverters
- Step 7:** Terminate the unused end of the cable
- Step 8:** Complete the installation of the junction box
- Step 9:** Connect the PV modules
- Step 10:** Energize the system

Horizontal mount

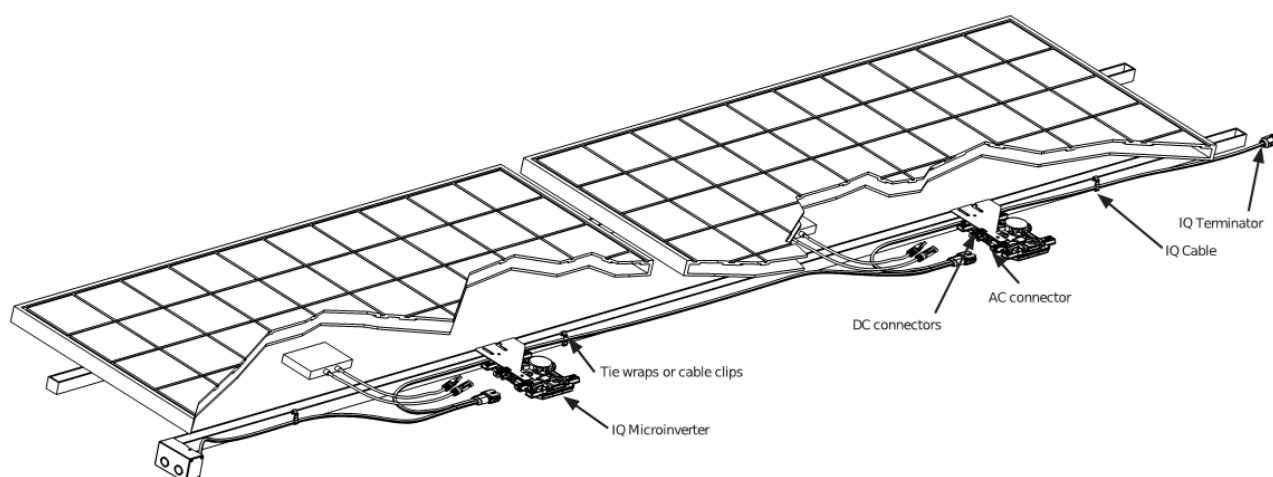

Vertical mount

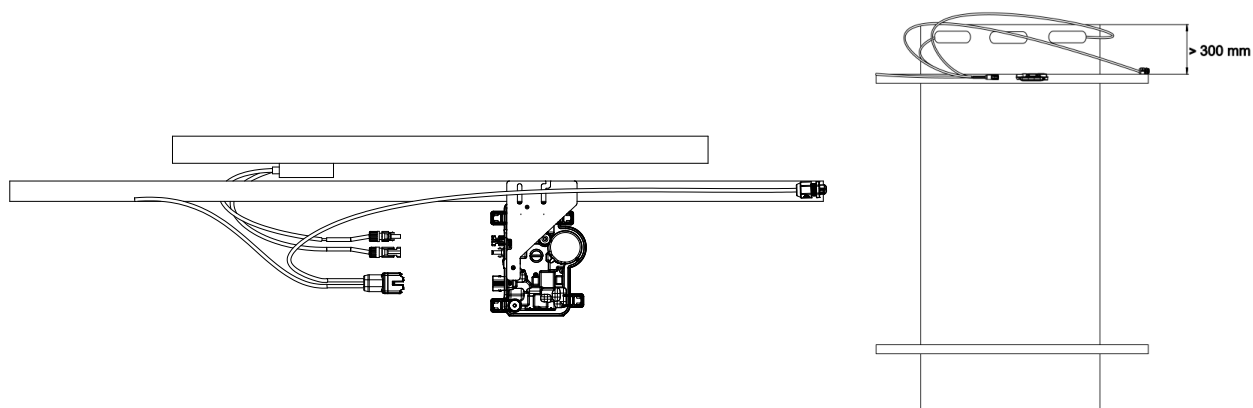

Step 1: Position the IQ Cable

- A. Plan each cable segment to allow drop connectors on the IQ Cable to align with each PV module. Allow extra length for slack, cable turns, and any obstructions.
- B. Mark the approximate centers of each PV module on the PV racking.
- C. Lay out the cabling along the installed racking for the AC branch circuit.
- D. Cut each segment of cable to meet your planned needs.



WARNING: When transitioning between rows, secure the cable to the rail to prevent cable or connector damage. Do not count on the connector to withstand tension.

Step 2: Position the junction box

- A. Verify that the AC voltage at the site is within range.

Service type and voltage: L1-L2	
240 VAC split-phase	211 to 264 VAC
208 VAC single-phase	183 to 229 VAC
220 VAC single-phase*	198 to 264 VAC



NOTE: All installations require that you use the IQ Gateway to commission the microinverters to propagate correct grid profile settings. This will also ensure that the microinverter's firmware is upgraded whenever a newer version is available.

* Only IQ8HC supports 220 V Grid in Mexico.

- B. Install a junction box at a suitable location on the racking.
- C. Provide an AC connection from the junction box back to the electricity network using equipment and practices as required by local jurisdictions.

Step 3: Mount the microinverters

- A. The microinverters should be mounted beneath the modules either horizontal bracket side up or vertical orientation to the module and must be protected from direct exposure to rain, UV, and other harmful weather events. Please refer to the image below for clearance requirements during vertical mounting.
 - Always place the microinverter under the PV module, protected from direct exposure to rain, sun, and other harmful weather events. Allow a minimum of 1.9 cm (3/4 in) between the roof and the microinverter. Also, allow 1.3 cm (1/2 in) between the back of the PV module and the top of the microinverter.
 - For vertical mount, maintain >30 cm (12 in) clearance from the edges of the PV module to protect the microinverter from direct exposure to rain, UV, and other harmful weather events.



WARNING: Install the microinverter under the PV module to avoid direct exposure to rain, UV, and other harmful weather events. Do not mount the microinverter upside down.

- B. Torque the microinverter fasteners as follows. Do not over-torque.
 - 6 mm (1/4 in) mounting hardware: 5 N m (45 in-lbs. to 50 in-lbs.)
 - 8 mm (5/16 in) mounting hardware: 9 N m (80 in-lbs. to 85 in-lbs.)
 - When using UL 2703 mounting hardware, use the manufacturer's recommended torque value.

Horizontal mount

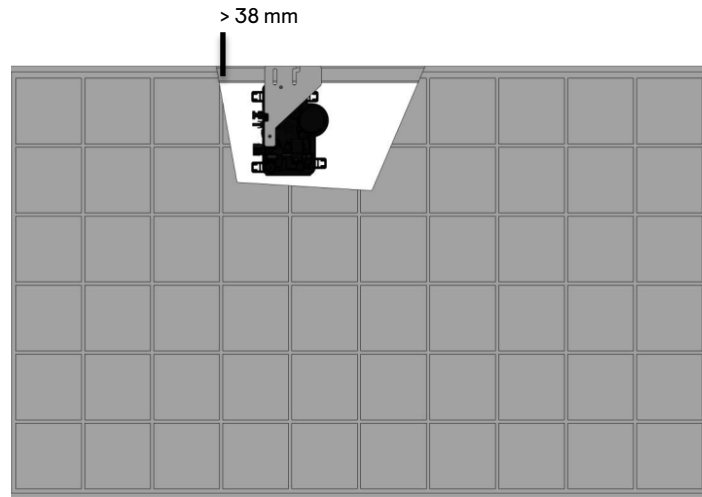

Vertical mount

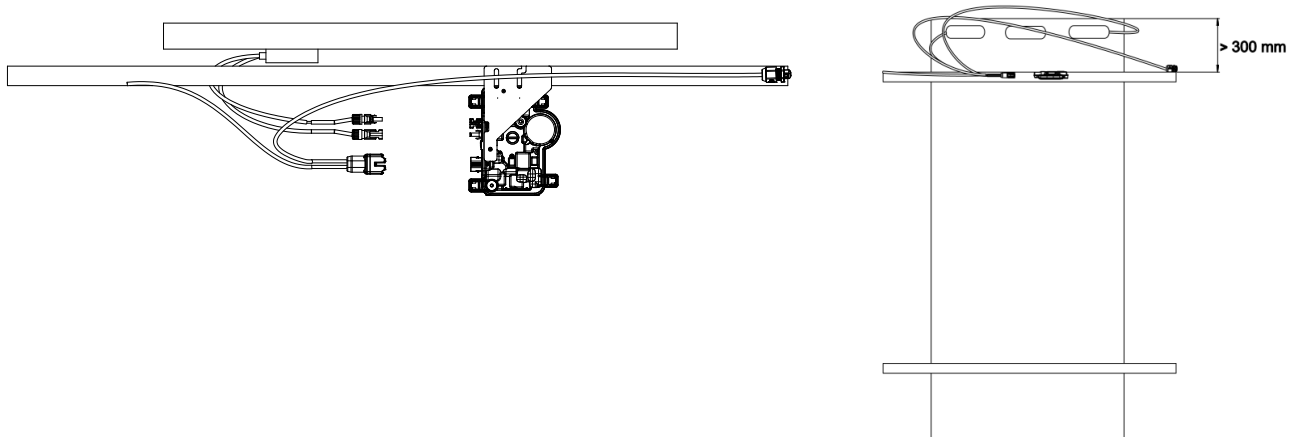

Step 4: Create an installation map

The Enphase installation map is a diagram of the physical location of each microinverter in your PV array. Copy or use the [blank map](#) to record microinverter placement for the system, or provide your layout if you require a larger or more intricate installation map.

Each Enphase microinverter, IQ Gateway, and IQ Battery has a removable serial number label. Build the installation map by peeling the serial number labels from the microinverter mounting plates and placing the labels on the map. After installation, you should place the IQ Gateway and IQ Battery serial numbers on the map.

After creating the installation map, use the Enphase Installer App to record serial numbers and configure the system. For details, refer to "Detect the microinverters" in the help topics of the Enphase Installer App.

- A. Peel the removable serial number label from each microinverter and affix it to the respective location on the paper installation map.
- B. Peel the label from the IQ Gateway and any IQ Battery (if installed) and affix it to the installation map.
- C. Always keep a copy of the installation map for your records.

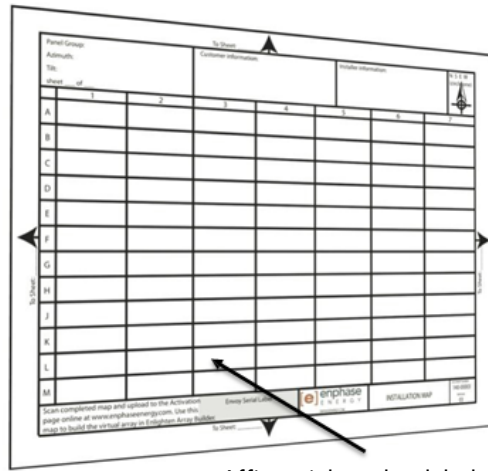

Affix serial number labels

Step 5: Manage the cabling

- A. Use cable clips or tie wraps to attach the cable to the racking. Leave no more than 1.8 m (6 ft) between cable clips or tie wraps.

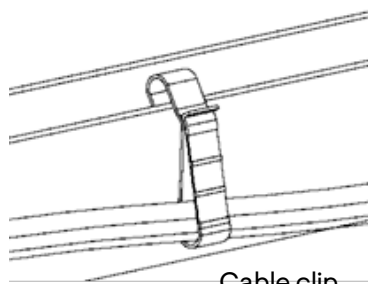

Cable clip

- B. Dress any excess cabling in loops to avoid contacting the roof. Do not form loops smaller than 12 cm (4¾ in) in diameter.



WARNING: Tripping hazard. Loose cables can become a tripping hazard. Dress the IQ Cable to minimize this potential.

Step 6: Connect the microinverters

- A. Connect the microinverter. Listen for a click as the connectors engage.
- B. Cover any unused connector on the IQ Cable with the IQ Sealing Cap. Listen for a click as the connectors engage.

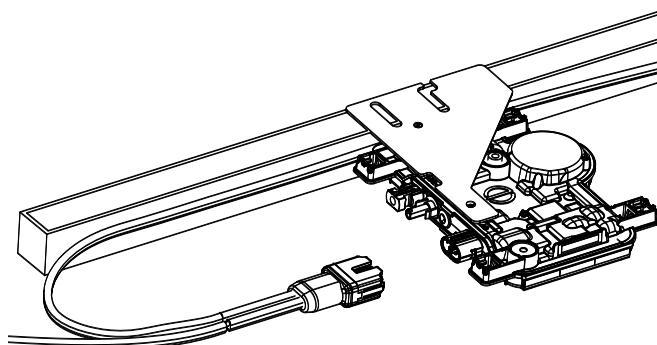



WARNING: Risk of electric shock. Risk of fire. Install IQ Sealing Caps on all unused AC connectors, as these connectors become live when the system is energized. IQ Sealing Caps are required for protection against moisture ingress.



NOTE: If you need to remove an IQ Sealing Cap, use the IQ Disconnect Tool. See [Disconnect a Microinverter](#).

Step 7: Terminate the unused end of the cable

Terminate the unused end of the IQ Cable as follows.

- A. Remove 13 mm (½ in) of the cable sheath from the conductors. Use the IQ Terminator loop to measure 13 mm.
- B. Slide the hex nut onto the cable. There is a grommet inside of the hex nut that should remain in place.
- C. Insert the cable into the IQ Terminator body so that each of the two wires land on opposite sides of the internal separator.

Terminator body

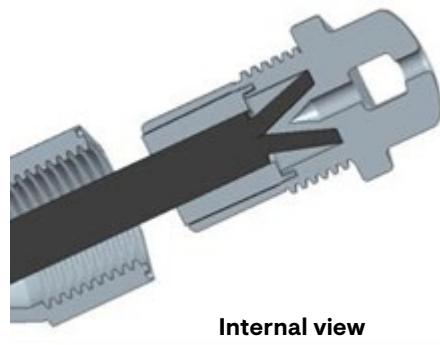
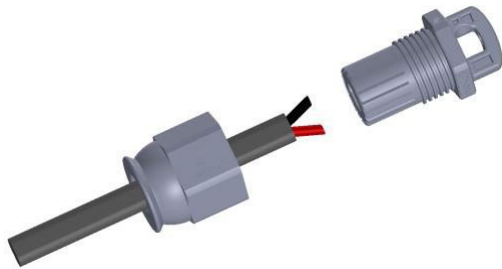
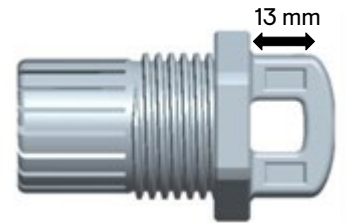

- D. Insert a screwdriver into the slot on the top of the IQ Terminator to hold it in place and torque the nut to 7 N m.
- E. Hold the IQ Terminator body stationary with the screwdriver and turn only the hex nut to prevent the conductors from twisting out of the separator.



NOTE: Turn only the hex nut to prevent conductors from twisting out of the separator.

- F. Attach the IQ Terminated cable end to the PV racking with a cable clip or tie wrap so that the cable and IQ Terminator do not touch the roof.



WARNING: The IQ Terminator cannot be re-used. If you unscrew the nut, you must discard the IQ Terminator.

Step 8: Complete the installation of the junction box

- A. Connect the IQ Cable to the junction box.
- B. Refer to the [wiring diagrams](#) for more information. Wire colors are listed in the following table.

Wire colors	
L1-Black	L2-Red

Step 9: Connect the PV modules



WARNING: Electrical shock hazard. The DC conductors of this photovoltaic system are ungrounded and may be energized.

- A. If required, attach the Enphase DC bulkhead adaptors to the microinverters. Make sure they are fully seated. Do not reverse the adaptor connections.
- B. Connect each PV module's DC leads to the corresponding microinverter's DC input connectors.
- C. Check the LED on the connector side of the microinverter. The LED flashes green six times when DC power is applied.
- D. Mount the PV modules above the microinverters.

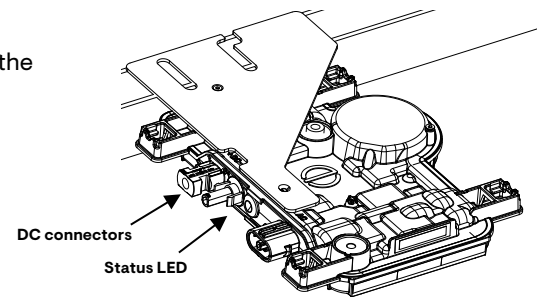

Step 10: Enphase Energy System configurations

Following are common system configurations possible with Enphase Energy System using IQ8 PV (IQ8MC/IQ8AC /IQ8HC/IQ8X) Microinverters.

- PV solar grid-tied
- PV solar grid agnostic
- PV solar + storage
- PV solar + generator
- PV solar + storage + generator

Based on System configuration, Enphase Energy system technology systems include the following Enphase products:

- **IQ Battery system** is an all-in-one AC coupled storage system that includes embedded, grid-forming multimode microinverters. You can connect multiple IQ Battery systems to maximize potential backup for homes. The IQ Battery 3 storage system allows customers to start small and add capacity incrementally. IQ Battery systems cannot be used with grid voltages of 208 volts or three-phase services.
- **IQ System Controller 2:** The Enphase Energy System includes the IQ System Controller with microgrid interconnection device (MID) capability, which consolidates interconnection equipment into a single enclosure and streamlines grid-independent capabilities of PV and storage installations by providing a consistent, pre-wired solution for residential applications. Along with MID functions, it includes PV, storage, and generator input circuits. It allows IQ Battery storage systems to form an intentional island (per IEEE 1547.4 definition) and contains a neutral-forming transformer (NFT) to enable 120/240 V operation in backup mode.
- **Wireless Communications Kit** enables direct communication between IQ Battery, IQ System Controller, and the Gateway using a 2.4 GHz frequency. The kit is connected to one of the USB ports on the IQ Gateway.
- **A Mobile Connect** cellular modem is required unless already present to ensure the best performance of your system. The cellular modem connects to a USB port on the IQ Gateway.
- For new or retrofit systems with IQ Series Microinverters:
 - **IQ8 PV (IQ8MC/IQ8AC /IQ8HC/IQ8X) Series Microinverters and accessories.** Enphase Energy System technology is fully compatible with IQ8 Series Microinverters.

- **IQ Gateway** is a communications gateway with IQ8 Series Microinverters, IQ Batteries, and the IQ System Controller smart switch. It collects system performance information and transmits it over the internet to Enphase Cloud. An IQ Gateway is required for Enphase Energy Systems with IQ Series Microinverters. Note the IQ Gateway is included in an IQ Combiner.
- **IQ Combiner** consolidates interconnection equipment into a single enclosure and streamlines PV and storage installations by providing a consistent, pre-wired solution for residential applications. It includes the IQ Gateway. Install the new communication kit in any IQ Combiner to enable wireless communication with IQ Battery and IQ System Controller.

Enphase Energy System PV solar grid-tied

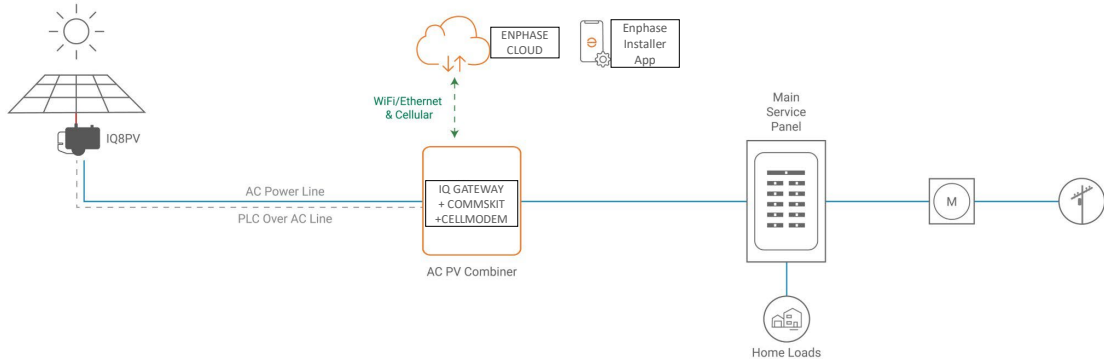

For the grid-tied mode, post IQ8 PV Microinverter installations, energize the system:

- Turn ON the AC disconnect or circuit breaker for the branch circuit.
- Turn ON the main utility-grid AC circuit breaker. Your system starts producing power after a five-minute wait time.
- Check the LED on the connector side of the microinverter:

LED color	Indicates
Flashing green	Normal operation. AC grid function is normal and there is communication with the IQ Gateway
Flashing orange	The AC grid is normal but there is no communication with the IQ Gateway
Flashing red	The AC grid is either not present or not within the specification
Solid red	There is an active DC Resistance Low, Power Off Condition . To reset, see DC Resistance Low – Power Off Condition

Refer to the IQ Gateway Quick Install Guide to install the IQ Gateway and set up system monitoring and grid management functions.

Enphase Energy System PV solar grid-agnostic

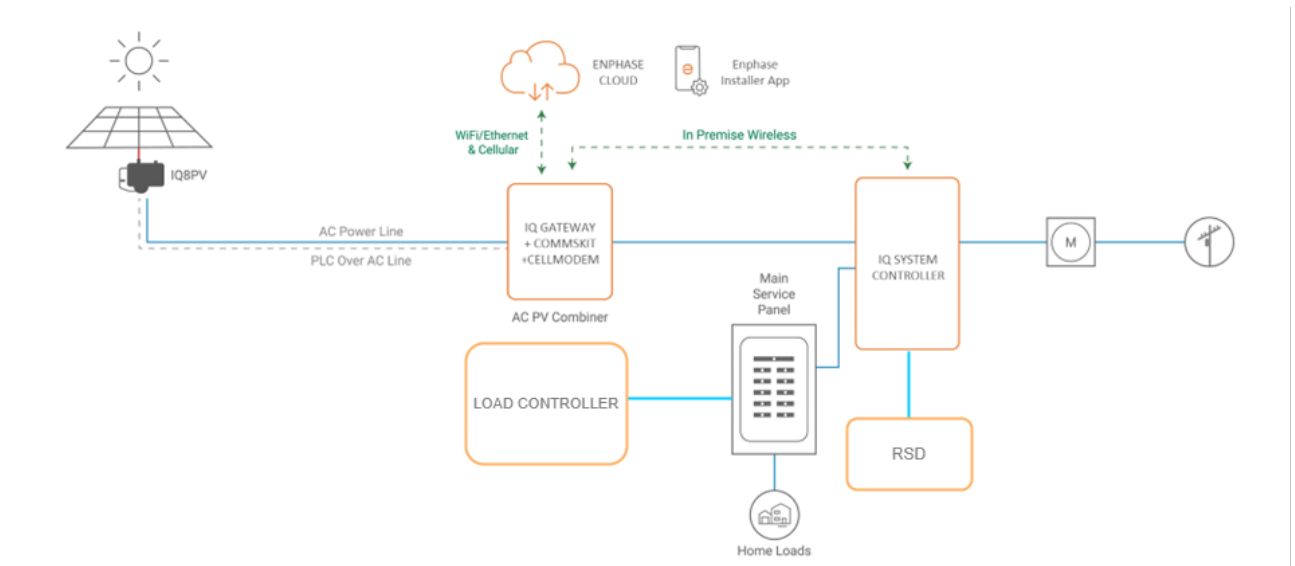

In the PV Solar Grid Agnostic configuration in Enphase Energy System, IQ System Controller is installed on the line side of the main load panels. This allows a properly sized Enphase Energy System to provide power to all loads in the main load panel in the event of a grid outage and PV solar presence. In this configuration, the IQ System Controller can be configured with a main breaker to act as the service disconnecting means. The PV system shall be interconnected to the IQ System Controller on a dedicated breaker. This configuration typically supports larger PV system sizes and may allow for avoiding expensive utility service and/or main service panel upgrades.

System commissioning for grid-agnostic configuration should be done with grid power present. During IQ8 PV installation, ensure all relays are open from the main panel and IQ System Controller. When commissioned, IQ System Controller gets powered on from the grid side of the microgrid interconnect device (MID); it closes the MID relay and PV relay. IQ8 PV shall start producing power in grid-tied mode with IQ Gateway power on. Follow the Enphase Energy System commissioning process using Enphase Installer App for system commissioning.

Enphase Energy System PV solar + storage – whole home backup configuration

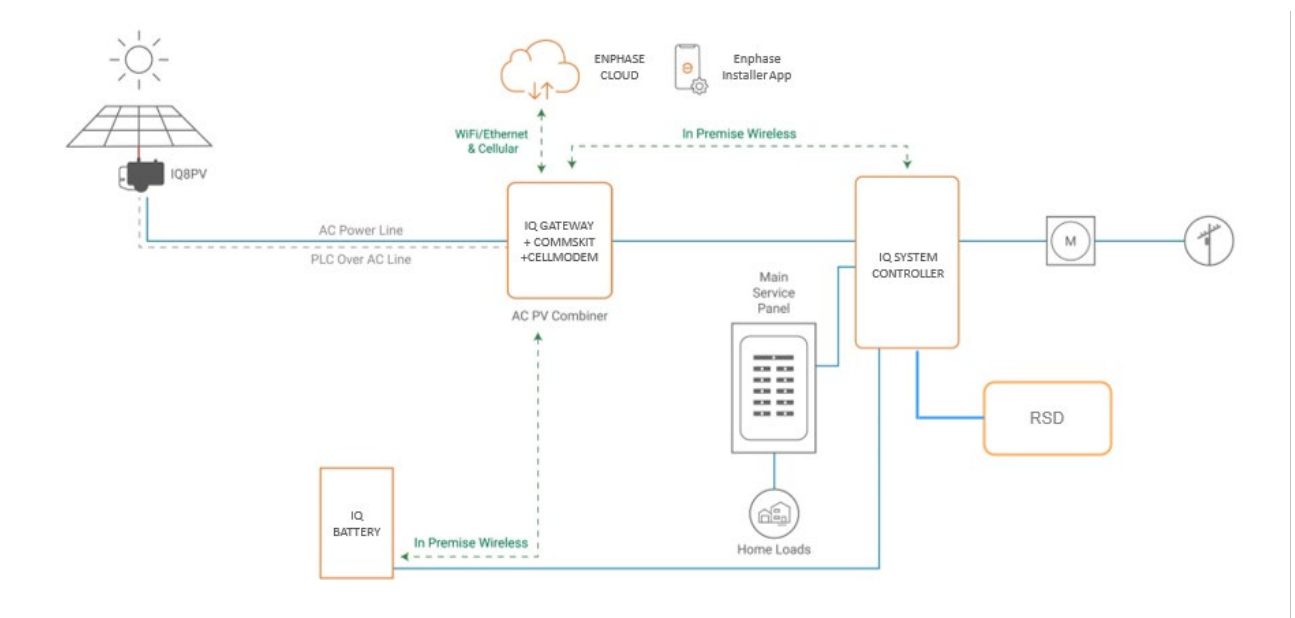

In the whole home (main load panel) backup configuration, IQ System Controller is installed on the line side of the main load panels rated up to 200 A. This allows a properly sized Enphase Energy System to provide power to all loads in the main load panel in the event of a grid outage. In this configuration, the IQ System Controller can be configured with a main breaker to act as the service disconnecting means. The PV system can be connected to the IQ System Controller on a dedicated breaker or to the main load panel. This configuration typically supports larger PV and storage system sizes and may allow for avoiding expensive utility service and/or main service panel upgrades.

The above configuration can also work with a genset connected to IQ System Controller with or without IQ Battery. The two images explain the connection configuration.

Enphase Energy System PV solar + generator configuration

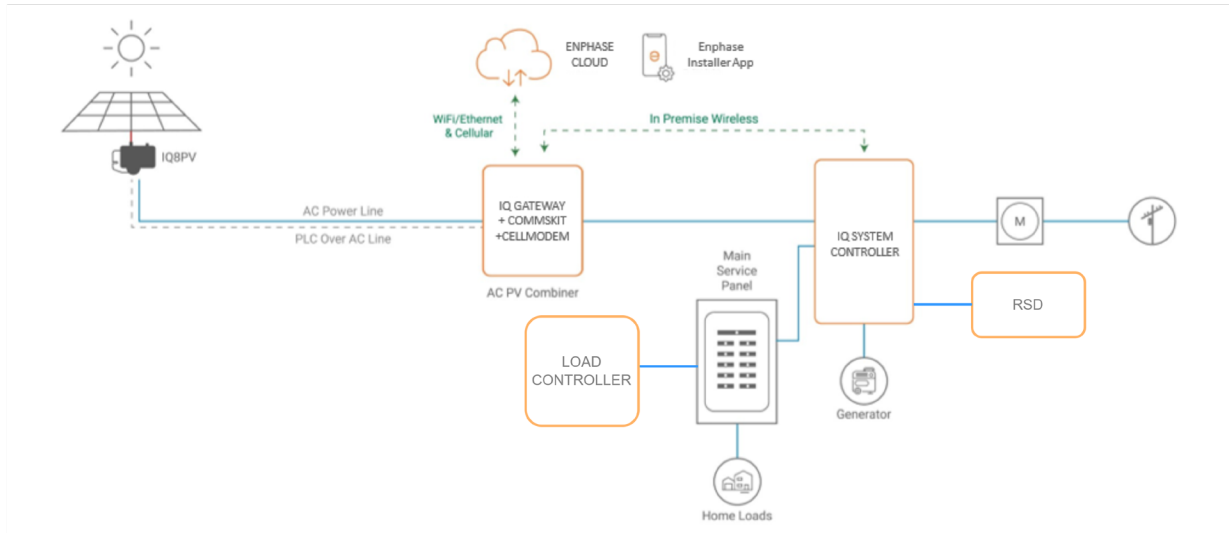

Enphase Energy System PV solar + IQ Battery + generator configuration

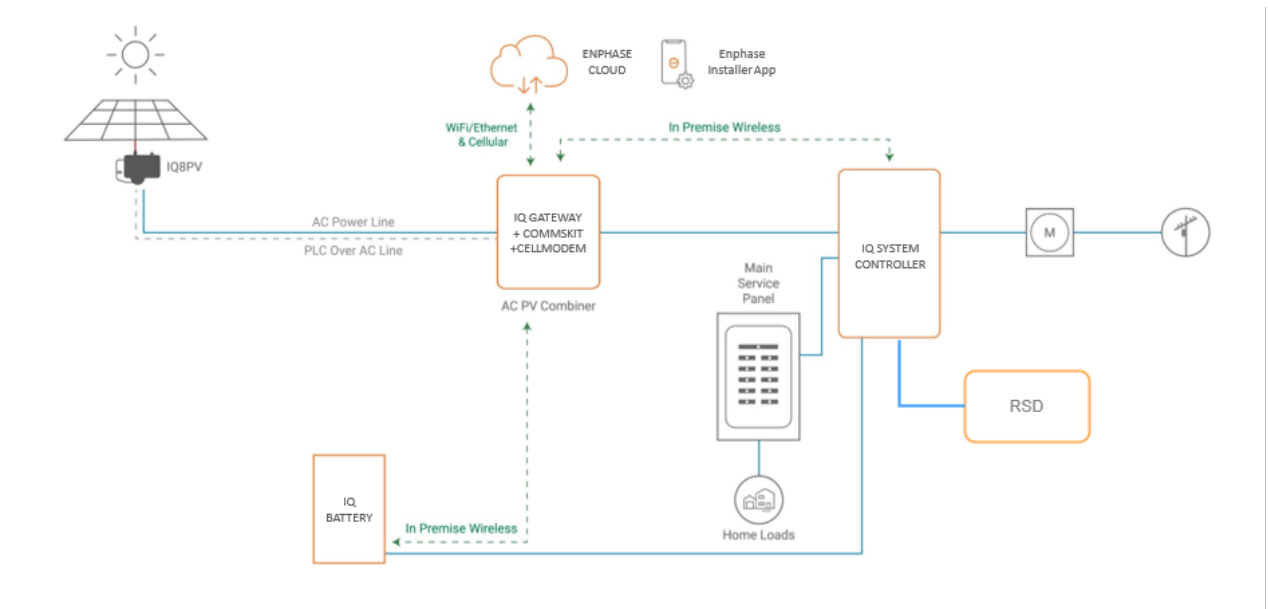

Set up and activate monitoring

Refer to the IQ Gateway Quick Install Guide to install the IQ Gateway and set up system monitoring and grid management functions. This guide leads you through the following:

- Connecting the IQ Gateway
- Detecting devices
- Connecting to the Enphase Installer Platform
- Registering the system
- Building the virtual array



NOTE: When the utility requires a profile other than the default IEEE 1547 (for example, grids managed by Hawaii electric industries [HEI], including HECO), you must select an appropriate grid profile for your installation.

You can set the grid profile through the Enphase Installer Platform, during system registration, or through Enphase Installer App at any time. You must have an IQ Gateway to set or change the grid profile. For more information on setting or changing the grid profile, refer to the IQ Gateway Installation and Operation Manual at [Enphase Support](#).

Troubleshooting

Follow all the safety measures described in this manual. Qualified personnel can use the following troubleshooting steps if the PV system does not operate correctly.



WARNING: Risk of electric shock. Do not attempt to repair the Enphase microinverter; it contains no user-serviceable parts. If it fails, contact [Enphase Support](#) to obtain a return merchandise authorization (RMA) number and start the replacement process.

Status LED indications and error reporting

The following section describes LED indications.

LED operation

LED color	Indicates
Flashing green	Normal operation. AC grid function is normal and there is communication with the IQ Gateway
Flashing orange	The AC grid is normal but there is no communication with the IQ Gateway
Flashing red	The AC grid is either not present or not within the specification
Solid red	There is an active DC Resistance Low, Power Off Condition . To reset, see DC Resistance Low – Power Off Condition below. Refer to IQ Gateway Installation and Operation Manual . If the problem persists, measure the resistance between PV+ to EARTH and then PV- to EARTH on the PV module and the inverter. Anything less than ~7 kΩ will trigger DC Resistance Low – Power Off condition. Usually, the value is in MΩ on the inverter or PV module. Swap out faulty PV module or microinverter.

The status LED on each microinverter lights green about six seconds after DC power is applied. It remains lit solid for two minutes, followed by six green flashes. After that, red blinks indicate that no grid is present if the system is not yet energized.

Any short red blinks after DC power is first applied to the microinverter indicate a failure during microinverter startup.

DC Resistance Low – Power Off condition

For all IQ8 Series Microinverters, a solid red status LED when DC power has been cycled indicates the microinverter has detected a DC Resistance Low – Power Off event. The LED will remain red, and the fault will continue to be reported by the gateway until the error has been cleared.

An insulation resistance (IR) sensor in the microinverter measures the resistance between the positive and negative PV inputs to the ground. If either resistance drops below a threshold of 7 kΩ, the microinverter stops power production and raises this condition. This may indicate defective module insulation, wiring or connectors, moisture ingress, or a similar problem. Although the cause may be temporary, this microinverter condition persists until the sensor is manually reset.

An IQ Gateway is required to clear this condition. The condition clears on operator command unless its cause is still present.

If a microinverter registers a "DC Resistance Low - Power Off" condition, you can attempt to clear this condition. If the condition does not clear after you perform the following procedure, contact [Enphase Support](#).

Follow the steps below to send a clear message to the microinverter. Note that the condition will not clear after the sensor reset if the cause of the failure is still present. If the condition persists, contact your installer.

Method: Clear this error using Enphase Installer Platform

1. Log in to the Enphase Installer Platform and access the system.
2. Click the **Events** tab. The next screen shows a current **DC Resistance Low – Power Off** condition for the system.
3. Click **DC Resistance Low – Power Off**.
4. Click the serial number of the affected microinverter.
5. Click **Tasks and Clear GFI** to clear the event.

Other faults

All other faults are reported to the gateway. Refer to the *IQ Gateway Installation and Operation Manual* at <https://enphase.com/installers/resources/documentation> for troubleshooting procedures.

Troubleshoot an inoperable microinverter

To troubleshoot an inoperable microinverter, follow the steps in the order shown.



WARNING: Risk of electric shock. Always de-energize the AC branch circuit before servicing. Never disconnect the DC or AC connectors under load.



WARNING: The Enphase microinverters are powered by DC power from the PV modules. Make sure you disconnect the DC connections and reconnect the DC power and then watch for the solid green for about six seconds after connection to DC power.

- A. Make sure AC circuit breakers and disconnects are closed.
- B. Check the connection to the grid and verify that the grid voltage is within allowable ranges.
- C. Verify that AC line voltages at all PV circuit breakers at the electrical panel and sub-panels are within the ranges shown in the following table.

240 VAC, single-phase	
L1 to L2	211 to 264 VAC
L1, L2 to ground	106 to 132 VAC
208 VAC, single-phase	
L1 to L2	183 to 229 VAC
L1, L2 to ground	106 to 132 VAC
220 VAC, single-phase **	
L1 to L2	198 to 264 VAC
L1, L2 to ground	106 to 132 VAC

** Only IQ8HC supports 220 V Grid in Mexico.

- D. Using an IQ Disconnect Tool, disconnect the AC cable for the microinverter in question from the IQ Cable.
- E. Verify that utility power is present at the microinverter by measuring line-to-line and line-to-ground voltage at the IQ Cable connector.
- F. Check that the AC branch circuit connections (IQ Cable and AC connections) are properly seated. Reset if necessary. Check for any damage, such as rodent damage.
- G. Make sure that any upstream AC disconnects, as well as the dedicated circuit breakers for each AC branch circuit, are functioning properly and are closed.
- H. Disconnect and reconnect the DC PV module connectors. The status LED of each microinverter will light solid green for a few seconds after connection to DC power and then flash green six times to indicate normal startup operation about two minutes after connecting to DC power. The LED subsequently resumes normal operation if the grid is present. See [normal LED operation](#).
- I. Connect a clamp meter to one of the conductors of the DC cables from the PV module to measure the microinverter current. This will be under 1 A if AC is disconnected.
- J. Verify the PV module DC voltage is within the allowable range shown in "Specifications". Refer to the Enphase compatibility calculator at <https://enphase.com/installers/microinverters/calculator> to verify PV module electrical compatibility with the microinverter.
- K. Swap DC leads with a known good, adjacent PV module. If, after checking the Enphase Installer Platform periodically (this may take up to 30 minutes), the problem moves to the adjacent module, this indicates that the PV module isn't functioning correctly. If it stays in place, the problem is with the original microinverter. Contact [Enphase Support](#) for help reading the microinverter data and for help in obtaining a replacement microinverter, if needed.
- L. Check the DC connections between the microinverter and the PV module. The connection may need to be tightened or reseated. If the connection is worn or damaged, it may need replacement.

- M. Verify with your utility that the line frequency is within range.
- N. If the problem persists, contact Enphase Support at [Enphase Support](#).

Disconnect a microinverter

If problems remain after following the troubleshooting steps, contact Enphase Support at [Enphase Support](#). If Enphase authorizes a replacement, follow the steps below. To ensure the microinverter is not disconnected from the PV modules under load, follow the disconnection steps in the order shown:

- A. De-energize the AC branch circuit breaker.
- B. IQ Cable AC connectors are tool-removable only. To disconnect the microinverter from the IQ Cable, insert the IQ Disconnect Tool and remove the connector.
- C. Cover the PV module with an opaque cover.
- D. Using a clamp meter, verify there is no current flowing in the DC wires between the PV module and the microinverter. If the current is still flowing, check that you have completed steps A, B, and C above.



NOTE: Take care when measuring DC, as most clamp meters must be zeroed first, as these tend to drift with time.

- E. Disconnect the PV module DC wire connectors from the microinverter using the IQ Disconnect Tool.
- F. If present, loosen and/or remove any bonding hardware.
- G. Remove the microinverter from the PV racking.



WARNING: Risk of electric shock. Risk of fire. Do not leave any connectors on the PV system disconnected for an extended period. If you do not plan to replace the microinverter immediately, you must cover any unused connector with an IQ Sealing Cap.

Install a replacement microinverter

- A. When the replacement microinverter is available, verify that the AC branch circuit breaker is de-energized.
- B. Mount the microinverter horizontally bracket side up or vertically:
 - Always place the microinverter under the PV module, protected from direct exposure to rain, sun, and other harmful weather events. Allow a minimum of 1.9 cm (3/4 in) between the roof and the microinverter. Also, allow 1.3 cm (1/2 in) between the back of the PV module and the top of the microinverter.
 - For vertical mount, maintain > 30 cm (12 in) clearance from the edges of the PV module to protect the microinverter from direct exposure to rain, UV, and other harmful weather events.



WARNING: Risk of equipment damage. Mount the microinverter under the PV module.

- Install the microinverter under the PV module to avoid direct exposure to rain, UV, and other harmful weather events.
- Always install the microinverter bracket side up for horizontal mount installations.
- Do not mount the microinverter upside down.
- Do not expose the AC or DC connectors (on the IQ Cable connection, PV module, or microinverter) to rain or condensation before the connectors are mated.
- C. Torque the mounting fasteners to the values shown. Do not over-torque.
 - 6 mm (1/4 in) mounting hardware: 5 N m (45 to 50 in-lbs.).
 - 8 mm (5/16 in) mounting hardware: 9 N m (80 to 85 in-lbs.).
 - When using UL 2703 mounting hardware, use the manufacturer's recommended torque value.
- D. If you are using bonding hardware, the old bonding hardware should be discarded, and new bonding hardware must be used when installing the replacement microinverter.
- E. Connect the microinverter to the IQ Cable connector. Listen for a click as connectors engage.

- F. Connect the DC leads of each PV module to the DC input connector of the microinverter.
- G. Re-mount the PV module above the microinverter.
- H. Energize the AC branch circuit breaker and verify the operation of the replacement microinverter by checking the status LED on the connector side of the microinverter.
- I. Use the Enphase Installer App to retire the old microinverter serial number from the IQ Gateway database. In Enphase Installer App, once connected to the IQ Gateway:
 - a. Tap **Devices & Array > IQ Microinverters & Array > IQ Microinverter Serial Number**
 - b. Tap **RETIRE** to retire the old microinverter serial number from the IQ Gateway database.
 - c. Add the new microinverter serial number to the gateway database by scanning the barcode using Enphase Installer App and your device camera.
 - d. Tap **Devices & Array > IQ Microinverters & Array > ADD DEVICES**. Scan the IQ8 Series Microinverter's barcode and assign it to the array.

OR

Go to **Service > Request return and install Replacement> Install Replacement**. Enter the original device serial number and replacement device serial number and submit.
- J. Start the provisioning process for the newly added microinverter using Enphase Installer App and connecting Enphase Installer App to IQ Gateway in AP mode. You can then **Start Provisioning Devices** through the Enphase Installer App.
- K. Ship the old microinverter to Enphase using the supplied return shipping label.

Enphase IQ Cable planning and ordering

The IQ Cable is a continuous length of 12 AWG, double insulated, outdoor-rated cable with integrated connectors for microinverters. These connectors are preinstalled along the IQ Cable at intervals to accommodate varying PV module widths. The microinverters plug directly into the cable connectors.

The cabling is compatible with a variety of PV racking systems. For a list of approved PV racking systems, refer to the PV Racking Compatibility document on the Enphase website at <https://enphase.com/installers/resources/documentation>

Connector spacing options

IQ Cable is available in three connector spacing options. The gap between connectors on the cable can be 1.3 meters, 2.0 meters, or 2.3 meters. The 1.3 meter spacing is best suited for connecting PV modules installed in portrait orientation, while the 2.0 meter and 2.3 meter are for landscape orientation.

IQ Cable options

Ordering options include:

Cable Model	Connector spacing	PV module orientation	Connector count per box
Q-12-10-240	1.3 m (50 in)	Portrait	240
Q-12-17-240	2.0 m (78 in)	Landscape (60-cell)	240
Q-12-20-200	2.3 m (90 in)	Landscape (72-cell)	200

The cabling system is flexible enough to adapt to almost any solar design. To determine the cable type you need, apply the following considerations:

- You may need to transition between cable types when mixing PV modules in portrait and landscape orientation. See the preceding table for available cable types.
- To transition between cable types, install a Field Wireable Connector pair.
- In situations where portrait modules are widely spaced, you may need to use landscape-spaced cables for the portrait-oriented PV modules and create loops of excess cable, if needed.



WARNING: Do not form loops smaller than 12 cm (4.75 in) in diameter.

Enphase IQ Cable accessories

The IQ Cable is available with several accessory options for ease of installation, including:

- **IQ Field Wireable Connectors (male):** (Q-CONN-10M) Make connections from any field wireable female connector.
- **IQ Field Wireable Connectors (female):** (Q-CONN-10F) Make connections from any IQ Cable open connector or Field Wireable male connector.
- **IQ Cable Clips:** (Q-CLIP-100) To fasten cabling to the racking or to secure looped cabling.
- **IQ Disconnect Tool:** (Q-DISC-10) Disconnect Tool for IQ Cable connectors, DC connectors, and AC module mount.
- **IQ Cable Sealing Cap (female):** (Q-SEAL-10) One needed to cover each unused connector on the cabling.
- **IQ Terminator:** (Q-TERM-10) One for each AC cable segment end; typically, two are needed per branch circuit.

Technical considerations

Be sure to apply the following when installing the Enphase IQ8 Series Microinverter System:



WARNING: Risk of equipment damage. You must match the DC operating voltage range of the PV module with the allowable input voltage range of the Enphase microinverter.



WARNING: Risk of equipment damage. The maximum open circuit voltage of the PV module must not exceed the specified maximum input voltage of the Enphase microinverter.

- PV modules must have conductors labeled "PV Wire" or "PV Cable" to comply with NEC for Ungrounded PV Power Systems.
- Verify that the voltage and current specifications of the PV module match those of the microinverter.
- The PV module's maximum short circuit current rating must be equal to or less than the microinverter's maximum input DC short circuit current rating.

The output voltage and current of the PV module depend on the quantity, size, and temperature of the PV cells, as well as the insulation of each cell. The highest PV module output voltage occurs when the temperature of the cells is the lowest and the PV module is at an open circuit (not operating).

Bifacial modules

Enphase IQ8 Series Microinverters are compatible with bifacial PV modules if the temperature-adjusted electrical parameters (maximum power, voltage, and current) of the modules, considering the electrical parameters, including the bifacial gain, are within the allowable microinverter input parameters range. In evaluating the amount of bifacial gain, follow the recommendations of the module manufacturers.

Bifacial solar modules produce power from both sides of a bifacial module, increasing total energy generation. The power gained from the rear side (bifacial gain) is highly influenced by various design factors such as albedo, module elevation, pitch, temperature, and shading. The bifacial gain can be anywhere between 0% to 30% of the module's nominal (front-side power rating). Since various design considerations highly influence the bifacial gain, pairing the bifacial module with the right microinverter depends on the electrical characteristics of a given module.

Specifications

See the specifications in the following tables for:

- IQ8MC-72-M-US Microinverters
- IQ8AC-72-M-US Microinverters
- IQ8HC-72-M-US Microinverters
- IQ8X-80-M-US Microinverters
- IQ Cable

IQ8MC-72-M-US Microinverter specifications

Enphase IQ8MC-72-M-US Microinverter parameters				
Topic	Unit	Min	Typical	Max
DC parameters				
Commonly used modules for pairing ¹	W	260–460		
Module compatibility		To meet compatibility, PV modules must be within the maximum input DC voltage and maximum module I_{sc} listed below. Module compatibility can be checked at https://enphase.com/installers/microinverters/calculator .		
MPPT voltage range	V	25		45
Operating range	V	18		58
Minimum/Maximum start voltage	V	22		58
Maximum input DC Voltage	V			60
Max. continuous operating DC current	A			14
Max. input DC short-circuit current	A			25
Max. module I_{sc}	A			20
Overvoltage class DC port			II	
DC port backfeed under single fault	A			0
PV array configuration	Ungrounded array; No additional DC side protection required; AC side protection requires max 20 A per branch circuit			
AC parameters				
Peak output power 240 VAC 208 VAC	VA		330 315	
Maximum continuous AC output power 240 VAC 208 VAC	VA		320 310	
Nominal grid voltage (L-L) 240 VAC 208 VAC	V		split-phase (L-L), 180° single-phase (L-L), 120°	
Minimum and Maximum grid voltage ² 240 VAC 208 VAC	V	211 183		264 229
Max continuous output current 240 VAC 208 VAC	A		1.33 1.49	
Nominal frequency	Hz		60	
Extended frequency range	Hz	47		68

AC short circuit fault current over three cycles	A_{rms}	2.7
Maximum microinverters per 20 A (max) AC branch circuit ³		
240 VAC		12
208 VAC		10
Total harmonic distortion	%	<5
Overvoltage class AC port		III
AC port backfeed current	mA	18
Power factor setting		1.0
Grid-tied power factor (adjustable)		0.85 leading ... 0.85 lagging
Peak efficiency	%	
240 VAC		97.4
208 VAC		97.2
CEC weighted efficiency	%	
240 VAC		97.0
208 VAC		96.5
Nighttime power consumption	mW	
240 VAC		33
208 VAC		25
Features and specifications		
Ambient temperature range		-40°C to 65°C (-40°F to 149°F)
Relative humidity range		4% to 100% (condensing)
DC connector type		Stäubli MC4
Dimensions (H × W × D)		212 mm (8.3") × 175 mm (6.9") × 30.2 mm (1.2")
Weight		1.1 kg (2.42 lbs)
Cooling		Natural convection - no fans
Approved for wet locations		Yes
Pollution degree		PD3
Enclosure		Class II double-insulated, corrosion-resistant polymeric enclosure
Compliance		
Compliance		CA Rule 21 (UL 1741-SA), UL 62109-1, IEEE1547:2018 (UL 1741-SB), FCC Part 15 Class B, ICES-0003 Class B, CAN/CSA-C22.2 NO. 107.1-01 This product is UL Listed as PV Rapid Shutdown Equipment and conforms with NEC 2014, NEC 2017, NEC 2020, and NEC 2023 section 690.12 and C22.1-2018 Rule 64-218 Rapid Shutdown of PV Systems for AC and DC conductors when installed according to manufacturer's instructions.

1. No enforced DC/AC ratio.
2. Nominal voltage range can be extended beyond nominal if required by the utility.
3. Limits may vary. Refer to local requirements to define the number of microinverters per branch in your area.

IQ8AC-72-M-US Microinverter specifications

Enphase IQ8AC-72-M-US Microinverter parameters				
Topic	Unit	Min	Typical	Max
DC parameters				
Commonly used modules for pairing ¹	W	295–500		
Module compatibility		To meet compatibility, PV modules must be within the maximum input DC voltage and maximum module I_{sc} listed below. Module compatibility can be checked at https://enphase.com/installers/microinverters/calculator .		
MPPT voltage range	V	28		45
Operating range	V	18		58
Minimum/Maximum start voltage	V	22		58
Maximum input DC Voltage	V			60
Max. continuous operating DC current	A			14
Max. input DC short-circuit current	A			25
Max. module I_{sc}	A			20
Overvoltage class DC port			II	
DC port backfeed under single fault	A			0
PV array configuration	Ungrounded array; No additional DC side protection required; AC side protection requires max 20 A per branch circuit			
AC parameters				
Peak output power 240 VAC (single-phase/split-phase) 208 VAC (single-phase/split-phase)	VA		366 350	
Maximum continuous AC output power 240 VAC (single-phase/split-phase) 208 VAC (single-phase/split-phase)	VA		349 345	
Nominal grid voltage (L-L) 240 VAC 208 VAC	V		split-phase (L-L), 180° single-phase (L-L), 120°	
Minimum and Maximum grid voltage ² 240 VAC 208 VAC	V	211 183		264 229
Max continuous output current 240 VAC 208 VAC	A		1.45 1.66	
Nominal frequency	Hz		60	
Extended frequency range	Hz	47		68
AC short circuit fault current over three cycles	A_{rms}		2.70	
Maximum microinverters per 20 A (max) AC branch circuit ³ 240 VAC 208 VAC			11 9	
Total harmonic distortion	%		<5	
Overvoltage class AC port			III	
AC port backfeed current	mA		18	

Power factor setting			1.0
Grid-tied power factor (adjustable)		0.85 leading ... 0.85 lagging	
Peak efficiency 240 VAC 208 VAC	%		97.3 97.2
CEC weighted efficiency 240 VAC 208 VAC	%		97.0 96.5
Nighttime power consumption 240 VAC 208 VAC	mW		30 22
Features and specifications			
Ambient temperature range		-40°C to 65°C (-40°F to 149°F)	
Relative humidity range		4% to 100% (condensing)	
DC connector type		Stäubli MC4	
Dimensions (H × W × D)		212 mm (8.3") × 175 mm (6.9") × 30.2 mm (1.2")	
Weight		1.1 kg (2.42 lbs)	
Cooling		Natural convection - no fans	
Approved for wet locations		Yes	
Pollution degree		PD3	
Enclosure		Class II double-insulated, corrosion-resistant polymeric enclosure	
Compliance			
Compliance		<p>CA Rule 21 (UL 1741-SA), UL 62109-1, IEEE1547:2018 (UL 1741-SB), FCC Part 15 Class B, ICES-0003 Class B, CAN/CSA-C22.2 NO. 107.1-01</p> <p>This product is UL Listed as PV Rapid Shutdown Equipment and conforms with NEC 2014, NEC 2017, NEC 2020, and NEC 2023 section 690.12 and C22.1-2018 Rule 64-218 Rapid Shutdown of PV Systems for AC and DC conductors when installed according to manufacturer's instructions.</p>	

1. No enforced DC/AC ratio.
2. Nominal voltage range can be extended beyond nominal if required by the utility.
3. Limits may vary. Refer to local requirements to define the number of microinverters per branch in your area.

IQ8HC-72-M-US Microinverter specifications

Enphase IQ8HC-72-M-US Microinverter parameters				
Topic	Unit	Minimum	Typical	Maximum
DC parameters				
Commonly used modules for pairing ¹	W	295–540		
Module compatibility		To meet compatibility, PV modules must be within the following maximum input DC voltage and maximum module I_{sc} . Module compatibility can be checked at https://enphase.com/installers/microinverters/calculator .		
MPPT voltage range	V	29.5		45
Operating Range	V	18		58
Minimum/Maximum start voltage	V	22		58
Maximum Input DC Voltage	V			60
Max. continuous operating DC current	A			14
Max. input DC short-circuit current	A			25
Max. module I_{sc}	A			20
Overvoltage class DC port			II	
DC port backfeed under single fault	A			0
PV array configuration		Ungrounded array; No additional DC side protection required; AC side protection requires max 20 A per branch circuit		
AC parameters				
Peak output power 240 VAC 208 VAC	VA		384 366	
Maximum continuous AC output power 240 VAC 208 VAC	VA		380 360	
Nominal grid voltage (L-L) 240 VAC 208 VAC	V		split-phase (L-L), 180° single-phase (L-L), 120°	
Minimum and Maximum grid voltage ² 240 VAC 208 VAC	V	211 183		264 229
Max continuous output current 240 VAC 208 VAC	A		1.58 1.73	
Nominal frequency	Hz		60	
Extended frequency range	Hz	47		68
AC short circuit fault current over 3 cycles	A_{rms}		2.70	
Maximum microinverters per 20 A (max) AC branch circuit ³ 240 VAC 208 VAC			10 9	
Total harmonic distortion	%		<5	
Overvoltage class AC port			III	
AC port backfeed current	mA		18	
Power factor setting			1.0	
Grid-tied power factor (adjustable)			0.85 leading ... 0.85 lagging	

Peak efficiency 240 VAC 208 VAC	%	97.3 97.2
CEC weighted efficiency 240 VAC 208 VAC	%	97.0 96.5
Nighttime power consumption 240 VAC 208 VAC	mW	22 26
Features and specifications		
Ambient temperature range	-40°C to 65°C (-40°F to 149°F)	
Relative humidity range	4% to 100% (condensing)	
DC connector type	Stäubli MC4	
Dimensions (H × W × D)	212 mm (8.3") × 175 mm (6.9") × 30.2 mm (1.2")	
Weight	1.1 kg (2.42 lbs)	
Cooling	Natural convection - no fans	
Approved for wet locations	Yes	
Pollution degree	PD3	
Enclosure	Class II double-insulated, corrosion-resistant polymeric enclosure	
Compliance		
Compliance	<p>CA Rule 21 (UL 1741-SA), UL 62109-1, IEEE1547:2018 (UL 1741-SB), FCC Part 15 Class B, ICES-0003 Class B, CAN/CSA-C22.2 NO. 107.1-01</p> <p>This product is UL Listed as PV Rapid Shutdown Equipment and conforms with NEC 2014, NEC 2017, NEC 2020, and NEC 2023 section 690.12 and C22.1-2018 Rule 64-218 Rapid Shutdown of PV Systems for AC and DC conductors when installed according to manufacturer's instructions.</p>	

1. No enforced DC/AC ratio.
2. Nominal voltage range can be extended beyond nominal if required by the utility.
3. Limits may vary. Refer to local requirements to define the number of microinverters per branch in your area.

IQ8X-80-M-US Microinverter specifications

IQ8X-80-M-US				
Topic	Unit	Minimum	Typical	Maximum
DC parameters				
Commonly used modules for pairing ¹	W	320–540		
Module compatibility		To meet compatibility, PV modules must be within the following maximum input DC voltage and maximum module I_{sc} Module compatibility can be checked at https://enphase.com/installers/microinverters/calculator .		
MPPT voltage range	V	43–60		
Operating range	V	25–79.5		
Minimum/Maximum start voltage	V	30/79.5		
Maximum input DC voltage	V	79.5		
Maximum continuous operating DC current	A	10		
Maximum input DC short-circuit current	A	16		
Maximum module I_{sc}	A	13		
Overvoltage class DC port		II		
DC port backfeed under single fault	A	0		
PV array configuration		Ungrounded array; no additional DC side protection required; AC side protection requires max 20 A per branch circuit		
AC parameters		UNITS		
Peak output power 240 VAC 208 VAC	VA	384 366		
Maximum continuous AC output power 240 VAC 208 VAC	VA	366 360		
Nominal grid voltage (L-L) 240 VAC 208 VAC	V	split-phase (L-L), 180° single-phase (L-L), 120° ⁴		
Minimum and Maximum grid voltage ² 240 VAC 208 VAC	V	211 183		264 229
Max continuous output current 240 VAC 208 VAC	A		1.58 1.73	
Nominal frequency	Hz		60	
Extended frequency range	Hz	47		68
AC short circuit fault current over three cycles	A_{rms}	2.70		

Maximum microinverters per 20 A (maximum) AC branch circuit ³			
240 VAC			10
208 VAC			9
Total harmonic distortion	%		<5
Overvoltage class AC port			III
AC port backfeed current	mA		18
Power factor setting			1.0
Grid-tied power factor (adjustable)		0.85 leading ... 0.85 lagging	
Peak efficiency			
240 VAC	%		97.3
208 VAC			97.0
CEC weighted efficiency			
240 VAC	%		96.5
208 VAC			96.5
Nighttime power consumption			
240 VAC	mW		26
208 VAC			12
Features and specifications			
Ambient temperature range		-40°C to 65°C (-40°F to 149°F)	
Relative humidity range		4% to 100% (condensing)	
DC connector type		Stäubli MC4	
Dimensions (H × W × D)		212 mm (8.3") × 175 mm (6.9") × 30.2 mm (1.2")	
Weight		1.1 kg (2.42 lbs)	
Cooling		Natural convection - no fans	
Approved for wet locations		Yes	
Pollution degree		PD3	
Enclosure		Class II double-insulated, corrosion-resistant polymeric enclosure	
Compliance			
Compliance		<p>CA Rule 21 (UL 1741-SA), UL 62109-1, IEEE1547:2018 (UL 1741-SB), FCC Part 15 Class B, ICES-0003 Class B, CAN/CSA-C22.2 NO. 107.1-01</p> <p>This product is UL Listed as PV Rapid Shutdown Equipment and conforms with NEC 2014, NEC 2017, NEC 2020, and NEC 2023 section 690.12 and C22.1-2018 Rule 64-218 Rapid Shutdown of PV Systems for AC and DC conductors when installed according to manufacturer's instructions.</p>	

1. No enforced DC/AC ratio.
2. The nominal voltage range can be extended beyond nominal if required by the utility.
3. Limits may vary. Refer to local requirements to define the number of microinverters per branch in your area.
4. IQ8X is not certified for use with Enphase Three Phase Network Protection Relay (NPR-3P-208-NA) and, therefore, designed for single-phase operation only. Check with the local utility requirements to install a single-phase inverter across three phases.

IQ Cable specifications

Specification	Value
Voltage rating	600 V
Voltage withstand test (kV/1min)	AC 3.0
Max DC conductor resistance (20°C) (Ω/km)	5.433
Insulation resistance (20°C)	≥20M (Ω/Km)
System temperature range (ambient)	-40°C to 65°C (-40°F to 149°F)
Cable temperature rating	90°C Dry/90°C Wet
Cable rating	DG
Certification	UL3003, TC-ER equivalent
Flame test rating	FT4
Cable conductor insulator rating	THHN/THWN-2
Environmental protection rating	IEC 60529 IP67NEMA 6
UV resistance	720 h
Compliance	RoHS, OIL RES I, CE, UV Resistant, combined UL for Canada, and the United States
Conductor size	12 AWG
Maximum loop size	12 cm (4.75")
Flat cable dimensions	6 mm x 9.5 mm (0.2" x 0.37")
Sealing cap dimensions	38.6 mm x 20 mm (1.5" x 0.7")
Cable connector dimensions	20 mm x 1.1 mm x 6.5 mm (0.7" x 0.04" x 0.25")

Enphase connector ratings

Enphase connectors on the cable assemblies in the following table have a maximum current of 20 A, a maximum OCPD of 20 A, and a maximum ambient temperature of -40°C to 79°C (-40°C to 174.2°F) and are rated for disconnection under load.

Part number	Model	Maximum voltage
840-00387	Q-12-10-240	277 VAC
840-00388	Q-12-17-240	277 VAC
840-00389	Q-12-20-200	277 VAC

Enphase installation map

Panel Group/Grupo de los paneles: Azimuth/Azimit: Tilt/Inclinación: Sheet/Hoja ____ of/de ____		Customer/Ciente:					Installer/Instalador:	
1	2	3	4	5	6	7		
A								
B								
C								
D								
E								
F								
G								
H								
J								
K								
L								
M								

To Sheet / A la hoja de: →
← To Sheet / A la hoja de:

To Sheet / A la hoja de: →
← To Sheet / A la hoja de:

Scan completed map and upload it to Enphase. Click "Add a New System" at <https://enlighten.enphaseenergy.com>. Use this map to build the virtual array in Enlighten's Array Builder. /

Escanee el mapa completo y cárguelo en Enphase. Haga clic en "Añadir nuevo sistema" en <https://enlighten.enphaseenergy.com>. Utilice este mapa para crear el conjunto de paneles virtual en el Creador de conjuntos de paneles de Enlighten.

Envoy Serial Number Label /
Número de serie de Envoy

Sample wiring diagram (grid-tied system)

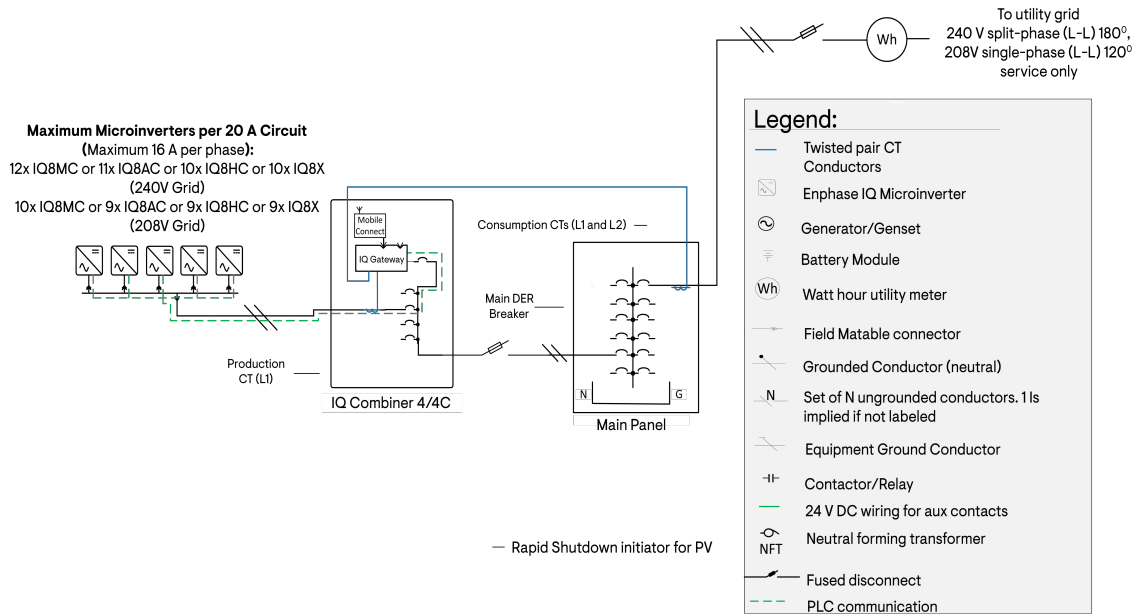

Revision history

Revision	Date	Description
USM-00008-2.0	November 2023	Added IQ8X Microinverter content.
USM-00008-1.0	September 2023	Initial release.

© 2023 Enphase Energy. All rights reserved. Enphase, the e and CC logos, IQ, and certain other marks listed at <https://enphase.com/trademark-usage-guidelines> are trademarks of Enphase Energy, Inc. in the US and other countries. Data subject to change.